

**Rehab
Right**
City of Oakland
Planning Department

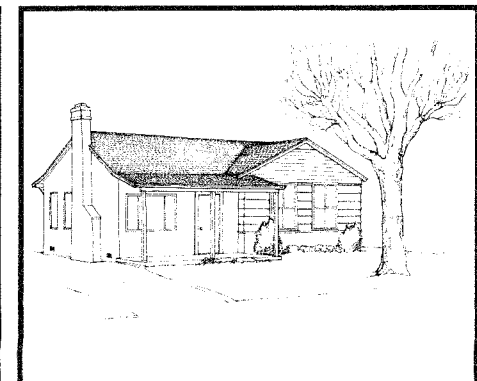

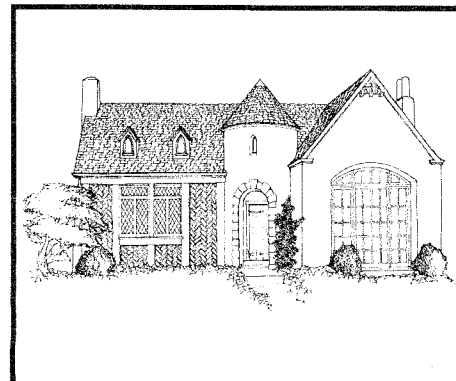

Italianate page 9
(mid 1860's-1880's)

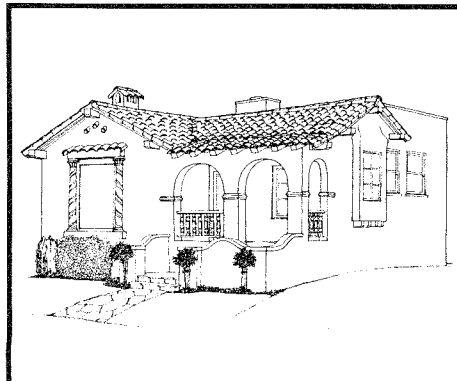
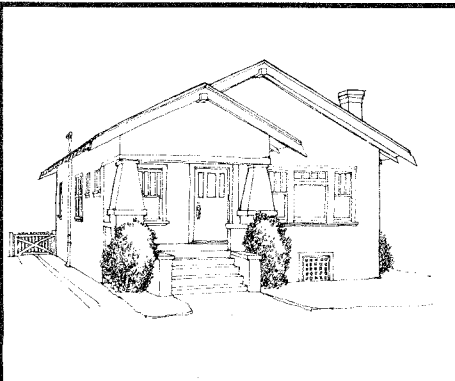
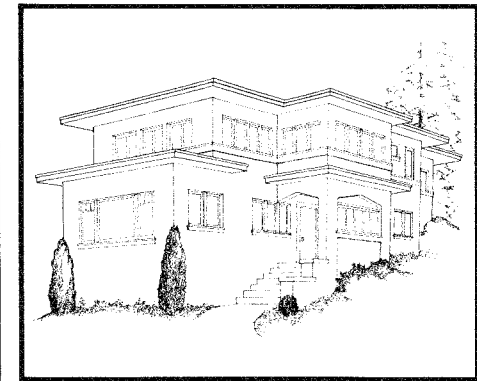
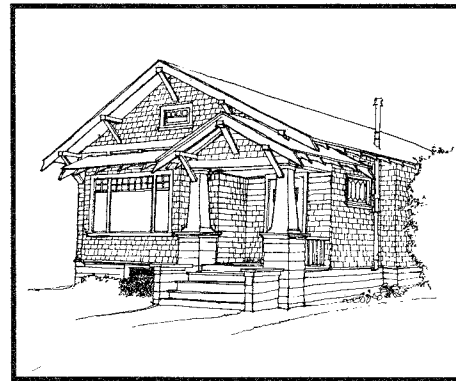
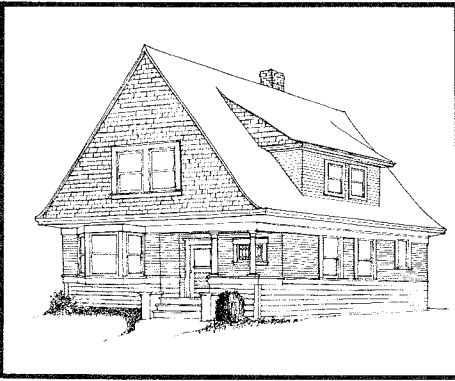
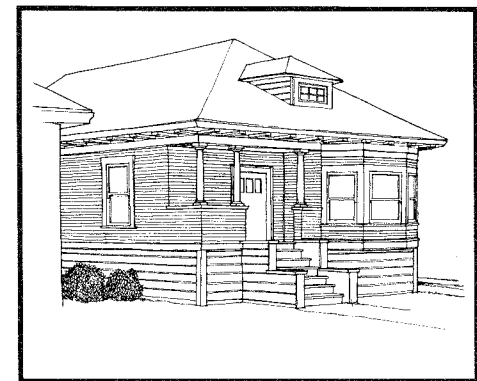

Single Story Italianate page 10
(mid 1860's-1880's)



San Francisco Stick page 11
(late 1870's-1890's)



Queen Anne page 13
(1883-1890's)



Queen Anne Cottage Page 14
(1883-1890's)



Classic Box page 16
(1890-1910)



Classic Box page 18
(1890-1910)

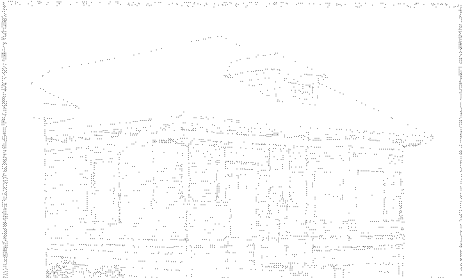

Neoclassic Rowhouse page 19
(1895-1915)

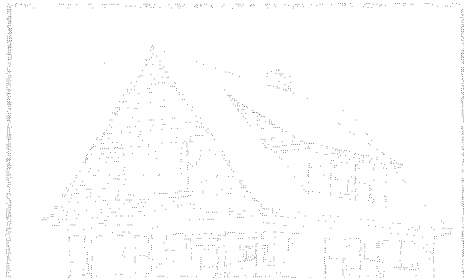

Eastern Shingle Cottage page 20
(1895-1910)



Brown Shingle page 22
(late 1890's-1915)



Craftsman Bungalow page 24
(1905-1925)



Prairie School page 26
(1910-1925)

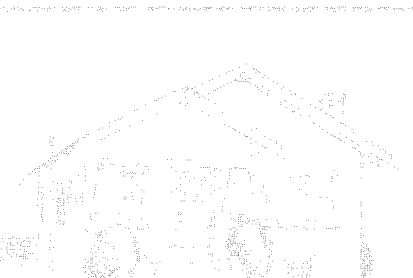

California Bungalow page 27
(1910-1925)



Mediterranean Style page 30
(1915-1935)

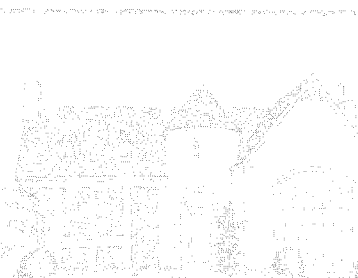

Provincial Style page 32
(1919-1935)

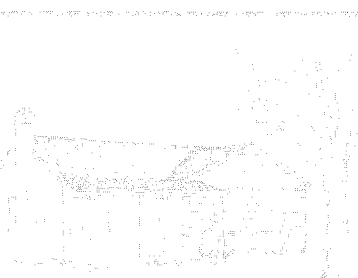

Wartime Tract page 33
(1942-1945)

Rehab Right

How To Rehabilitate Your Oakland House Without Sacrificing Architectural Assets

**City of Oakland
Planning Department
June, 1978**

The preparation of this book was supported in part by funds from:

The National Endowment for the Arts, a Federal agency, Washington D.C. The findings herein do not necessarily represent the views of the Endowment.

The City of Oakland Office of Community Development, under the Community Development Block Grant Program, U.S. Department of Housing and Urban Development.

The State of California, Office of Historic Preservation, under the National Historic Preservation Act of 1966.

© 1978 City of Oakland
All reproduction rights reserved.

Third Printing
June, 1980

OCPD 239

DISCLAIMER

REHAB RIGHT fills the gap in home repair literature left by conventional home improvement books (typically insensitive to architectural design) and by restoration manuals (usually cursory in their technical explanations). As a result, the instructions in **REHAB RIGHT** range from simple methods to complicated projects. In cases where adequate information is well presented in other readily available publications, reference has been so made to avoid repetition.

The difficulty factor depends on the experience of the reader. Whether novice or know-it-all, safety procedures should be observed, tools and materials properly cared for, and common sense the guiding light. Conditions in old houses vary, so it is up to the reader to adapt directions to the situation at hand. This is as much a matter of applying the philosophy of **REHAB RIGHT** as it

is of skill at construction. Despite best efforts to be thorough, some questions will undoubtedly stand unanswered. A reader in doubt as to procedure or outcome should seek further advice or assistance. (Helpful sources are described in Chapter 3 and Chapter 6.)

The names of stores, suppliers and products are included solely to demonstrate that certain items which facilitate **REHAB RIGHT** methods are in fact available. No endorsement or warranty by the City, or by any of the supporting agencies, is expressed or implied. A listing does not suggest that the named supplier is the exclusive source or the least expensive source of any product. Prices quoted are subject to change without notice. For specific products, always follow the manufacturer's directions. ■■

TABLE OF CONTENTS

PREFACE	1
----------------------	----------

CHAPTER 1. THEY DON'T MAKE HOUSES LIKE THEY USED TO

Let Your House Be Itself	3
The Difference Between Restore, Rehabilitate, and Remodel	3
How to Use REHAB RIGHT	5

CHAPTER 2. THE ARCHITECTURAL STYLE OF YOUR OAKLAND HOUSE

The Concept of Architectural Style	
What's In A Name	7
Architectural Portraits	7
Architectural Portraits of Oakland House Styles	
Typically in Need of Rehab	
Victorian	8
Italianate	9
San Francisco Stick	11
Queen Anne	12
Colonial Revival	15
Classic Box	17
Neoclassic Rowhouse	19
Eastern Shingle Cottage	20
First Bay Tradition	21
Brown Shingle	23
Craftsman Bungalow	24
Prairie School	25
California Bungalow	27
Period Revival	29
Mediterranean Style	30
Provincial Style	31
All-American Ranch Style	33
Wartime Tract	33

CHAPTER 3. BEFORE YOU BEGIN

How Much Money Should You Spend on Rehab?	
Establish Your Goals, Understand Your Motives	35
Do the Basics First	35
Don't Spend More Than You Can Afford	35
Avoid Overimprovement	36
When Should You Hire a Professional?	
And When Should You Do It Yourself?	38
Selecting a Contractor	38
Drafting a Contract	39
Is Your House Up To Code?	
How to Determine the Applicable Code	40
Compliance Letter	41
Permits are a Bonus, Not a Burden	42
Termite Reports	43
Earthquake Safety	44

CHAPTER 4. EXTERIORS

Foundation	45
Brick Foundation	45
Concrete Foundation	46
Posts and Piers	47
Sill Plate	48
Anchor Bolts	48
Seismic Anchor	48
Crawl Space	49
Clearance	49
Vents	49
Insulation	50
Stairs	50
Wood Stairs	50
Brick Stairs	51
Concrete Stairs	51
Handrails	52
Porch	54
Wood Porch	54
Wood Damage	54
Posts and Piers	54
Joists and Decking	55
Columns	55

Railings	56
Roof	57
Stucco Porch	58
Cement Porch	59
Front Door	60
Wear	60
Panels	60
Veneer	61
Paint	61
Ornamentation	62
Threshold	62
Hardware	62
Security	62
Garage Door	65
Sheathing	65
Wood Siding	65
Design	65
Damage and Repair	66
Wood Shingles	67
Stucco	68
Mass-Produced Siding	70
Ornamentation	70
Wood Ornamentation	
Removal	71
Repair	71
Replacement	71
Re-installation	74
Plaster Ornamentation	74
Paint	74
When to Paint	74
The Painting Process	75
Color Selection	75
Windows	78
Design	78
Repair and Replacement	81
Energy	82
Security	83
Roof	84
Roofing	84
Vents	84
Flashing	85
Gutters and Downspouts	86
Eave, Fascia, and Soffit	87
Chimney	88

CHAPTER 5. INTERIORS

Floors	89
Subfloor	89
Finish Floor	89
Hardwood Floor	89
Softwood Floor	94
Ceramic Tile Floor	94
Resilient Flooring	94
Walls	95
Plaster	95
Wood	98
Lincrusta-Walton	100
Panelling	101
Paint	101
Wallpaper	104
Trim	105
Removing Walls	109
Ceiling	109
Surface	109
Space	110
Special Features	110
Rosette	110
Trim	111
Beams	111
Coved Corners	111
Doors	112
Style	112
Fit	113
Damage	113
Doorframe	115
Hardware	115
Fireplace	116
Exterior Appearance	
Style	116
Repair	117
Internal Workings	118
Staircase	119
Style	119
Repair	120
Utility Systems	123
Electricity	123
Service	123
Wiring	125

Light Fixtures	126
Plumbing	128
Mechanical	130

CHAPTER 6. SOURCES AND RESOURCES

City Offices	131
Rehabilitation Assistance Programs	133
Classes	136
Books	137
Preservation Organizations	138
Housing Organizations	139
Materials	140

CREDITS	inside back cover
---------	-------------------

TABLE OF ILLUSTRATIONS

Oakland House Styles Typically In Need of Rehabilitation	inside front cover
---	--------------------

CHAPTER 1. THEY DON'T MAKE HOUSES LIKE THEY USED TO

Residential Area Names	6
------------------------	---

CHAPTER 2. THE ARCHITECTURAL STYLE OF YOUR OAKLAND HOUSE

Victorian	
Italianate	9
Single-Story Italianate	10
San Francisco Stick	11
Queen Anne	13
Queen Anne Cottage	14
Colonial Revival	
Classic Box	16, 18
Neoclassic Rowhouse	19
Eastern Shingle Cottage	20
First Bay Tradition	
Brown Shingle	22
Craftsman Bungalow	24
Prairie School	26
California Bungalow	27
Period Revival	
Mediterranean Style	30
Provincial Style	32
All-American Ranch Style	
Wartime Tract	33

CHAPTER 3. BEFORE YOU BEGIN

Categories of Applicable Code	40
-------------------------------	----

CHAPTER 4. EXTERIORS

Foundation	
How to Repoint	45

Typical Mortar Joints	46
Brick Patterns	46
Concrete Corner Repair	47
Post and Pier Elevation	47
Post and Pier Construction	48
Anchor Bolt	48
Seismic Anchor	49
Crawl Space	
Vent Styles	49
Crawl Space Clearance	50
Crawl Space Insulation	51
Stairs	
Stair Dimensions for Brand New Construction Required by Modern Code	51
Improving Drainage on Wood Steps	52
Steel Nosing on Concrete Steps	52
Stair Railing Reconstruction	52
Stair Railing Alternatives for the Neoclassic Rowhouse	53
Porch	
Porch Balustrade Reconstruction	55
Porch Railings to Avoid	56
Awning Substitute for Porch Overhang	56
Stickwork Repair	57
Elephantine Column Repair	58
Elephantine Columns: Do's and Don't's	59
Cement Porch Floor Repair with Flashing	60
Front Door	
How to Replace Door Glass	61
How to Replace Door Threshold	61
Door Security: Reinforced Door Frame	63
Door Security: Braced Studs	63
Door Security: Non-Removable Hinge Pin	63
Front Door: Do's and Don't's	64
Door Security: Precaution for Exterior Hinge Pin	64
Door Security: One Architect's Solution	64
Door Security: Original Door Knob as Handle with Auxiliary Lock	65
Sheathing	
Types of Wood Siding	66
Shingle Patterns	67
Shingle Installation Detail	68
Stucco Construction	69
Ornamentation	
Removing Wood Ornamentation	71
Ornamentation Vocabulary	72
Proportional Reproduction: A Cornice	74

Paint	
Color Wheel	75
Value	75
Parts of a House to Paint	76
Windows	
Types of Woodframe Windows	78
Double-Hung Window: Do's and Don't's	79
Parts of a Double-Hung Window	80
Double-Hung Window Frame Detail	80
Double-Hung Window Weatherstrip Placement	83
Window Security: Key Lock for Double-Hung Windows	83
Window Security: Vulnerability of Aluminum Frames	83
Roof	
Soffit Vent	85
Porch Roof Flashing	86
Valley Flashing	86
Good and Bad Downspout Locations	86
Drip Strip	87
Maybeck Downspout	87

CHAPTER 5. INTERIORS

Floors	
Types of Strip Flooring	89
Parts of a Floor	90
Fixing Squeaky Floors	91
Remedies for Loose Floorboards	92
Sheet Vinyl: Do's and Don't's	95
Walls	
Plaster Repair	96
Extensive Plaster Repair	97
Sheetrock: Do's and Don't's	97
Wainscot Styles and Vocabulary	98
Re-creating a Wainscot	99
Lincrusta-Walton	101
Cross Section of a Plywood Panel	101
Parts of a Room to Paint	102
Basic Molding Shapes	105
Reproducing Complex Moldings	106
Adding a Window Cap	107
Molding to Avoid	107
The Difference Between a Structural Wall and a Permanent Partition	108
Ceiling	
Ceiling: Do's and Don't's	110
Rosette Cross-Section	111

Coved Ceiling Detail	112
Doors	
Types of Doors	112
Panel Door Construction	113
Flush Door Construction	114
Panel Door Repair	114
Typical Problems on Interior Doors	115
Victorian Doors	116
Fireplace	
Installing an Add-on Mantel	117
Rescuing a Remodelled Mantel	118
Parts of a Fireplace	119
Staircase	
Parts of a Staircase	120
Newel Post	122
Staircase Carpeting: Do's and Don't's	122
Utility Systems	
Identifying Your Electrical Service	123
Adding a Wall Switch for an Overhead Light	125
Socket and Switch: Do's and Don't's	125
How to "Fish"	126
Light Fixture: Do's and Don't's	127
A Clawfoot Tub with Added Shower	129

CHAPTER 6. SOURCES AND RESOURCES

Community Development District Boundaries	134
Ruler	inside back cover

TABLE OF "DON'T" ILLUSTRATIONS

Stair Railing Alternatives for the Neoclassic Rowhouse	53
Porch Railings to Avoid	56
Elephantine Columns: Do's and Don't's	59
Front Door: Do's and Don't's	64
Double-Hung Windows: Do's and Don't's	79
Good and Bad Downspout Locations	86
Sheet Vinyl: Do's and Don't's	95
Sheetrock: Do's and Don't's	97
Molding to Avoid	107
Ceiling: Do's and Don't's	110
Socket and Switch: Do's and Don't's	125
Light Fixture: Do's and Don't's	127

TABLE OF CHARTS

REHAB RIGHT Guidelines	5
Bank of America Home Improvement Loans	37
Permit Fees For Activities Typically Associated with Residential Rehabilitation	42
Window Prices	82
Roofing Materials	84

PREFACE

In cities nationwide, popular interest in older houses has been directed toward historic restoration. Great sums have been invested in the re-creation of a landmark building's original features for the sake of academic precision and, often, for snob appeal. But too often, when a more commonplace house becomes deteriorated, most of the energy is directed toward just making the house liveable again. The goal is to eliminate hazardous conditions and to install basic amenities. Anything more is frosting.

While it is critical that the shelters be made habitable, it is equally imperative that the architectural character of all buildings be respected in the process of structural improvement. Unfortunately, this is rarely the case in Oakland. The intrinsic merit of a building is often sacrificed to the expediency of contemporary contracting technique.

This handbook was conceived as an easy-to-use guide to design decisions, in the hope that the architectural integrity of Oakland's homes will no longer be unnecessarily lost. A good design decision for a repair problem requires satisfactory answers to three straightward questions: How will it look? How will it work? And, how much will it cost? REHAB RIGHT addresses these questions for typical home improvement problems encountered in Oakland's older residential building styles.

There are so many different people who influence the outcome of residential rehabilitation projects in Oakland that this publication serves a variety of needs. Foremost, REHAB RIGHT is written for **Oakland homeowners**. Do you own a house here? Use this manual to discover the qualities your house has, the built-in design assets you may not even realize it boasts. These assets have resale value. Then, use this book to prepare for home improvement by recognizing which problems you have to solve and determining the best plan of attack. When you become acquainted with the technical jargon, you will be better equipped to communicate to a contractor or a hardware salesman that you want the job done the best way possible. Perhaps a previous owner made some so-called "improvements" and the changes are not to your liking. Use REHAB RIGHT to rectify past mistakes. On the larger scene, read this book to find out how the efforts of individual property owners can contribute to the upgrading of an entire neighborhood.

Maybe you are **potential Oakland homeowners**, looking for a place to buy. Lately, many people are drawn to Oakland by the design quality and human scale of older neighborhoods. REHAB RIGHT will help you evaluate houses that are for sale and make an intelligent selection among them. It should also give you some idea of any additional investment necessary beyond the sale price to bring the house up to legal standards or your own personal taste.

Real estate agents, eager to discover which features make a house marketable, will find REHAB RIGHT a useful tool in appraising the value of residential architecture and passing this knowledge on to the consumer. The characteristics that help sell

the house this time should be retained by the new owner to help sell the house next time around.

Some people turn to **professional contractors** for advice on home improvement. While most contractors know how to get the job done, many could profit by more design sensitivity. REHAB RIGHT should stir the imagination of any skilled craftsman. Esthetics notwithstanding, this booklet provides the contractor with a handy checklist of rehab problems.

Some **City employees** are in a position to design rehabilitation projects. Others review applications for special low interest rehabilitation loans. Still others must make daily decisions regarding code compliance, land use regulations, permit issuance, and the like. REHAB RIGHT is directed at honing City employees' appreciation of Oakland's distinctive residential styles, so that a professional understanding of local architecture is intrinsic to any related recommendations made in the City's name for the public good.

Actually, **any Oakland property owner** could benefit from REHAB RIGHT. Many of the design concepts apply equally well to commercial structures or apartment buildings. **Any Oakland resident** would broaden his or her environmental perception by learning to recognize different house styles by name. An awareness of Oakland's architectural heritage will foster common sense decisions about residential rehabilitation, and an enthusiasm for doing the job the right way. ■

Chapter 1.

THEY DON'T MAKE HOUSES LIKE THEY USED TO

LET YOUR HOUSE BE ITSELF

One of the very best things about Oakland is the vital mix of cultures among our resident population. There are so many different and interesting people, that living here is practically an international experience. The social diversity is stimulating, the way life in a city is supposed to be. Likewise, Oakland possesses a spectrum of residential building styles. Houses of strikingly different appearance—from 1875, 1905, 1935, 1965—stand side by side, creating a physical setting as variegated as Oakland's social environment.

Lately, individuals of many different ethnic backgrounds are intent upon discovering their "roots," tracing their cultural history. They value the role that the past has played in determining their personal identity; they treasure the unique qualities of a distinctive heritage. It is a disheartening realization that the integrity of so many a culture has been diluted in the great American melting pot, the valuable distinctions homogenized. So it is with architecture too. A house reflects history—the attitudes, the technology, the spirit of the era in which it was built. Most houses built before World War II also reflect great care and quality in their craftsmanship and materials. Every house has its own personality, its own story to tell. What a shame that the integrity of so many an older house has been needlessly

dishonored by modernization techniques which, like the melting pot, tend to make everything look the same.

Of course, most older houses are in need of some improvements to make them safe and convenient. But **you can make your living environment feel new without eliminating what is old and valuable.** Let's take the analogy between the residents and the residences of Oakland one step further. This is the generation of the natural look in personal grooming. The "natural look" does not mean sloppy or dirty, it means comfortable and honest, being yourself. Rosy cheeks come from being in the sun, not from a palette of rouge. Curly hair is no longer straightened, but allowed to wave, then cut to complement the shape of the face. The same principle of pride in basic features applies to home repairs; let your house be itself. You can freshen up without covering up.

There's a big difference between structural improvements and interior decoration. Structural improvements are home repairs related to the skeleton of the house—the floor you stand on, the roof over your head. They are architectural features which concern building and construction—the "nuts and bolts" that have a permanent importance for you and any subsequent owners of the house. REHAB RIGHT will help you to make and implement those important design decisions. Interior decoration, on the other hand, is more superficial and shorter lived. It is the selection of a wallpaper pattern—not the installation of wall studs; it's the selection of café curtains—not the replacement of a dryrotted window sill. Of course, effective interior decoration depends upon a good structural framework. Picking out a wardrobe for yourself is not the same as jogging around Lake Merritt to stay in shape, although everyone knows that a stylish outfit will look a lot better on a healthy physique.

While it is appropriate to use your individual taste in decorating your home, resist the temptation to impose your personality on the structure of the house. If, for example, you like vivid colors, consider hanging bright posters in the living room instead of painting the outside of the house a garish hue. If you have a collection of souvenirs

from Mexico, you need not stucco your house, roof it with red tile, and surround it with white gravel to achieve an interesting display.

Think of your house as a whole, a single unit with no removable parts. Every change you make chips away at the integrity of the whole, every feature removed is drastic surgery. Before you know it, efforts to personalize and update a house will leave you with an assortment of miscellaneous parts that bear no relation to each other, let alone to the original design. Wrought iron columns, asbestos shingles, and aluminum frame windows have only one thing in common: the local hardware store. A house is not like a car which has options available to obscure the mass production. It's just the opposite: older houses in Oakland were built one at a time, and such added options obscure their individuality.

An article in the *Wall Street Journal* points out that because people invest such a large portion of their earnings in the purchase of a house they focus their leisure activities on the home too. Home improvement has become a form of recreation. Whether tools and lumber, brushes and buckets, are your idea of fun, or a matter of sheer necessity, be sure that the "improvements" you make respect the form and the materials of the original house. The spaces and details were deliberately arranged and selected for proportion and consistency when the house was first built. The design as a whole has a visual purpose and an economic value that are yours to appreciate, yours to safeguard, yours to benefit from when it's time to resell.

THE DIFFERENCE BETWEEN RESTORE, REHABILITATE, AND REMODEL

There is so much activity these days in the improvement of older housing that a new set of verbs has been introduced into common parlance. Most of the words start with the prefix *re*—which means to begin anew, and it is not hard to become confused among the definitions. The variations in meaning between *restore*, *rehabilitate*, and *remodel*, may

seem subtle, but the words represent powerful attitudes which make all the difference in the way a job turns out.

To restore a house is to return a building to its original condition, as if it were a precious museum piece. This technique is typically used for structures of significant merit, like historic landmarks, where accuracy will serve an educational purpose as well as a visual one. Restoration is the most painstaking improvement process, and often the most expensive, because it requires technical skill and academic precision for successful results. It can involve the removal of extraneous, anachronistic elements, as well as the re-creation of original features which have become deteriorated or destroyed. For example, on a Victorian house, the wood portico may have succumbed to dry rot. In restoring the house, the replacement for the defective overhang would be an honest reproduction of the original—the same dimensions, the same joinery, even the same materials as its predecessor. An enormous challenge lies in accurately discovering the past and sensitively displaying that heritage in the present.

A fine example of a restoration project in Oakland is the Camron-Stanford House. This Italianate mansion built in 1876 on the shores of Lake Merritt, at Lakeside Drive, went through several incarnations: as the lavish residence of newlyweds Alice Marsh and Will Camron, as the lively hub of Josiah Stanford's social circle, as the headquarters for the Oakland Museum and, in what many feared would be its dying days, as an abandoned and desolate mansion dubbed "Lady of the Lake."

In 1971, through the efforts of the Camron-Stanford Preservation Association, the restoration project began. The needed repairs were substantial. The rear annex had to be demolished, and the interior walls reconstructed. When at last the Camron-Stanford house received a fresh and accurate paint job three years later, it was reinstated as a gem in the public eye. Beginning in the spring, 1978, the house will be headquarters for special programs on Oakland history, with an emphasis on residential architecture.

Remodelling a house is normally at the opposite

end of the improvement spectrum from restoration. Unless it is done with unusual sensitivity, **to remodel a house is to redesign it so that the generic features are obliterated and the basic character destroyed in the name of modernization.** A remodelling job is too often considered a "success" if the original structure is unrecognizable in the result. This technique is appropriately used for buildings which were constructed of inferior materials or for buildings which have fallen into a state of irreversible disrepair due to vacancy or vandalism. Remodeling can also be a proper course of action when a structure undergoes a dramatic change in use, say from a single-family residence to commercial office space.

Unfortunately, it is quite common for a house to be remodelled and totally divested of its valuable characteristics when conditions do not require such radical treatment. Hence, the expression "remodel" has acquired a bad connotation. To many people, it suggests a shameful waste of valuable resources, even though it is possible to remodel with sensitivity, especially with the help of a talented architect.

Examples of remodeling jobs can be found in Oak Center where many houses were so devastated by abandonment, theft and a complete lack of maintenance, that the only feasible solution was to "gut" the interior—that is, to remove all remnants of original style. Doors, molding, rosettes, coved ceilings, wainscoting, everything down to the studs in the walls were dismantled and construction started all over again from the eviscerated frame. The new version is typically distinguished by sheetrock walls with a hint of baseboard, aluminum windows, and snazzy light fixtures. Other examples of remodeling can be found in homes where the owners were convinced, sometimes with the help of a contractor or salesman, that, without qualification, "old" is bad and "new" simply wonderful.

In the vast space that separates restoration from remodeling we find rehabilitation. **To rehabilitate a house is to take corrective measures which will make the structure liveable again.** The British use the word "recondition," and lately we've adopted the abbreviation "rehab." **Some aspects of rehab work entail renovation, the introduction of brand new elements.** For example, the electrical circuits

may have to be rewired to provide adequate service for today's appliances.

The other face of rehabilitation is preservation, the retention of valuable existing elements. For example, it was a matter of course in 1905 to construct oak floors, inlaid with geometric borders, in the living and dining rooms of Colonial Revival houses. Preserving these floors is intrinsic to proper rehabilitation and would be accomplished in two ways. First, during construction, the hardwood would be covered by a protective dropcloth to avert any additional damage while other carpentry is underway. Later, when the floors are ready for attention, the oak would be sanded and varnished, returning the irreplaceable hardwood to its original richness. In contrast, a remodeling job would treat the valuable oak as if it were ordinary fir, leaving paint cans and lumber on the floor during repairs, and then covering the fascinating textured grain with homogenous shag carpeting when the job is done.

When rehabilitating a house, **it is essential to protect the structural and decorative characteristics which belong to the architectural style. These are the very features which constitute the visual integrity and economic value of the building. Modern elements should only be introduced when absolutely necessary for legal or utilitarian purposes. Modern elements should only be introduced in a manner that is sympathetic to the original design spirit, and never at the expense of irreplaceable assets.** That is what is meant by **REHAB RIGHT.**

Good examples of REHAB RIGHT can be found in homes where family members have done the repairs themselves, lovingly, and where a limited budget prevented the family from purchasing all new hardware. Forced financially to appreciate what they have, these households actually end up with a finished product more valuable for its integrity than any assemblage of replacement parts could ever be.

The rewards of sensitive home improvement are many fold. First, there is the satisfaction of knowing you've done the job right. Second, there is the gratification of compliments from other people who

appreciate that you've done the job right. Third, there is the limitless pleasure of living in an attractive and comfortable home. While these benefits are difficult to measure, a fourth reason to REHAB RIGHT can be quantified in dollars and cents. A perceptive combination of restoration and renovation will actually contribute to the resale value of your home. Finally, a good rehab project can be surprisingly influential on an entire block. Improvements in neighborhood quality can also be calculated in monetary terms when it comes to real estate.

HOW TO USE REHAB RIGHT

This handbook is written to tune-up architectural awareness and to convince you that good design makes good economic sense. If you study the book from first paragraph to last you'll know more than enough to make wise rehab decisions. But most readers will have acquired a copy of REHAB RIGHT with a specific residence in mind and they will be anxious to get to the solution of their repair problems without delay. In fact, even in formal discussions about home improvement with architects and contractors, the conversation invariably turns to the professional's own home. Recognizing that each reader will focus on the portion of the manual which affects him or her personally, REHAB RIGHT is organized so the information you and your house need can be quickly selected.

First, **discover your house.** Step outside and take a good look at the building. Walk around it. Touch it. Explore the materials. Do you find clapboard siding or stucco? Wood shingles or asbestos? Single out the details. Are there columns on the porch, pediments on the windows, finials on the roof? Cross the street and look at it from a distance. Appreciate its mass, its overall shape. Is the structure tall, narrow and rectangular or low, spreading and irregular in form? Try to sum up its personality. Is your house noble and ornate? Natural and hand-crafted? Or, traditional and trim?

With a refreshed image of your house in mind, come back inside, find a comfortable seat near a reading lamp, and turn to **Chapter 2, "The Ar-**

chitectural Style of Your Oakland House." There you'll find drawings and descriptions of 13 Oakland residential styles typically in need of rehabilitation. By leafing through the illustrations and reviewing the definitions, you'll likely experience a burst of recognition when you find just the right name for the architectural style of your own home.

The name provides useful clues about the structural and decorative features which merit respect and deserve retention. The name also alerts you to potential repairs because within each of the architectural descriptions you'll find that specific rehab problems are predicted for the different styles.

Chapter 3, "Before You Begin," offers suggestions to consider prior to launching any improvement work at all. How much money should be spent on rehab? When should you hire a professional? What is applicable code? Remember, you'll need City permits for the building projects you undertake. The permit procedure, a discussion of termite reports, and some simple guidelines to make home repairs quake-safe, are included.

Now you're at the heart of REHAB RIGHT. **Chapter 4 "Exteriors" and Chapter 5 "Interiors"** present over one hundred repair problems commonly encountered in the improvement of Oakland homes. (Don't worry, you won't have to face *all* 100 on your house.) For each problem, one or more solutions are described and illustrated, with an indication of the cost. The cause of existing damage is explained. Code restrictions are mentioned where appropriate to remind the reader that in addition to physical and financial constraints there are legal limitations on home improvement too. Consult the **Table of Contents** for the page number of the precise topic that interests you.

Chapter 6 lists "**Sources and Resources.**" If REHAB RIGHT has left you with questions unresolved, this chapter will direct you to people and places who can help.

On the back cover you'll find a built-in ruler, in centimeters and inches both, for taking quick measurements when you are so motivated that you can't take the time to look for a yardstick, and so engrossed in REHAB RIGHT that you just can't put the book down. 

REHAB RIGHT GUIDELINES

- **Retain original houseparts and materials wherever possible. As a rule, if damage is present, repair is visually and economically preferable to replacement.**
- **If replacement is necessary, replace parts and materials in-kind.**
- **If replacement in-kind is impossible due to availability or cost, the replacement should at least reproduce the salient visual characteristics of the original, such as material, composition, proportion, and color.**
- **If used, modern house parts should be incorporated with sensitivity to the architectural style.**
- **Wherever possible, replace missing house parts and remove inappropriate modernization.**

Residential Area Names

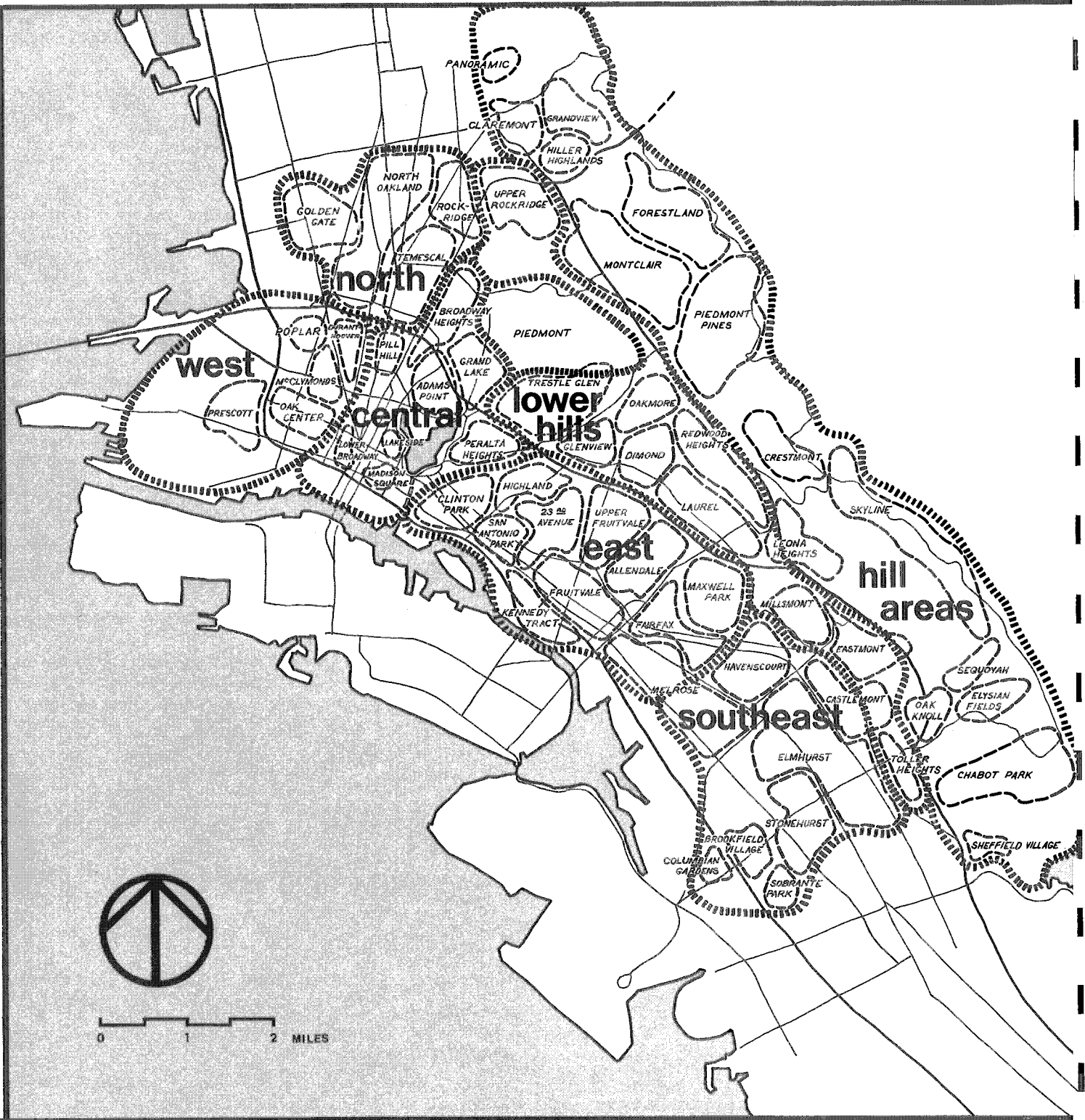

Chapter 2.

THE ARCHITECTURAL STYLE OF YOUR OAKLAND HOUSE

THE CONCEPT OF ARCHITECTURAL STYLE

What's In A Name?

There are so many ways to remember a house. The smell of it, the feel of it, the sound, the cost, the look of it. In addition, every house has a name which communicates the picture in just a few words. The architectural style is a convenient handle which sums up the *form* of the building—like size, shape, room arrangement, interior spaces,—and the *details* within that form—such as ornamentation, hardware, doors, floors, and fireplace. When a building is a style its appearance is not just a random collection of parts. All the features of the building work together to produce a single image. The dimensions of the windows are proportioned to the height and width of the entire house, and the materials selected for siding complement the structural shape. Every choice is a deliberate choice for a consistent overall impression. An individual component may stand out for its craftsmanship or flair, but its most important role is its contribution to the visual integrity of the building as a whole.

The forces which bring about architectural style are many: technology, materials at hand, fashion trends, cultural baggage, family needs, budget, topography, climate, transportation, public utilities, and a host of others. So the name of a style tells us more than what a house looks like. The name can tell us where the house came from, how it was constructed, when it was built, even who lived there. Architectural styles are classified at two levels. The more general category indicates a resemblance due to common origin, like a person's last name does. The more specific category sorts out the distinctive characteristics that define a unique personality, like a person's first name. For example, "Victorian" is the name of an architectural family in which all the kin were built in the late nineteenth century with wood siding and flashy decoration. Within the family, each relative has its own expressive appearance. The Italianate is tall and thin, the Queen Anne, broader with gables, the San Francisco Stick, flat and boxy. If you know enough to call a house "Victorian" that's good, but calling it an "Italianate Victorian" is that much better. The more precise the name of the style, the more explicit the picture, and the more likely you are to REHAB RIGHT.

Architectural Portraits

The architectural portraits in this chapter are in words and drawings both. The verbal descriptions supplement the sketches, so what you can't find in the illustration you might discover in the text. The portraits represent prototype examples of 13 styles. In theory, identification should be fairly simple by comparing your own house with the one pictured. If the details, or the form, or both, jibe, then you are in luck.

In reality, however, your house may possess characteristics that are not shown, or may lack some that are shown. Do not despair. There is great variety within architectural families, and crossbreeding among the separate styles often produces one-of-a-kind hybrids. You might say, for example, "I have a Brown Shingle house with Classical porch columns."

Years of remodeling efforts also make it difficult to

identify an architectural style. The obvious clues to a building's rightful name may have been hidden or destroyed by well-intentioned repairmen. If you find yourself in that position, look around the neighborhood for houses with similar patterns to yours, but more original features still intact. The arrangement of windows and doors, for example, and especially the presence of bays and porticos, are useful clues when the columns have rotted, the brackets have been removed, or the clapboard siding has been covered with asbestos shingles. If you can give a name to the house nearby that's an "older" version of your own, like Neoclassic Rowhouse, then you could call yours a "Denatured" Neoclassic Rowhouse.

Other houses are hard to categorize because their plainness borders on the nondescript. Again, look for clues, no matter how subtle, in the volume, the proportion, the construction, the ornament, the age. If you come up with a name, like Prairie School, you could call your house "Simplified" Prairie School.

Some houses are literally camouflaged by the addition of a commercial structure built up to the sidewalk at the front of the first floor. This ruse may keep overhead down, but it doesn't do much good for the architecture. Commercial conversions are typically found on Queen Anne cottages and Neoclassic Rowhouses.

In Oakland, almost every architectural style exists in a large and small version. Both sizes may share the same name, like the mansion-sized Queen Anne and the cottage-sized Queen Anne, or they may assume different names, like the large Brown Shingle, and its smaller counterpart, the Craftsman Bungalow. Design trends were cleverly adapted to variations in family size and budget, without sacrificing quality or aesthetics. There is no reason why the same can't hold true today in the process of rehabilitation. The portraits show the styles as they should look (not necessarily the way they do), so you can use the sketch as a guide for preservation or replacement.

This chapter does not include every Oakland house style, and intentionally so. The gallery illustrates only those styles typically in need of rehab. Several

styles were omitted because they are too rare, too new, or consistently well-maintained. Even if your house is not pictured, the general design principles and repair techniques offered in this book still apply.

The design and technical recommendations are as applicable to multi-family residences as they are to single family units. Unlike modern apartment buildings which could be mistaken for a motel, many older apartment buildings have the appearance of a "house" and warrant sensitive improvement. The suggestions are also useful for rows of commercial structures in the City's older neighborhood centers. Too often these attractive blocks have been awkwardly modernized.

Students of architectural history may take issue with the unqualified praise bestowed on each architectural style. This primer is not meant to be an academic critique. REHAB RIGHT is a tool to improve appreciation of Oakland's architectural heritage, even if some of our local styles are not noteworthy in the context of the international building design. In fact, the City's architect-designed houses are only incidental to the discussion. This is a book about vernacular architecture, the houses in which Oakland people live.

In Chapter 1, under the heading "How To Use REHAB RIGHT" you were encouraged to step outside, take a walk around your house, and become reacquainted with its appearance. If you have not yet done so, try it now. A fresh look at the architectural style you inhabit will make this chapter a lot easier for you to use.

ARCHITECTURAL PORTRAITS OF OAKLAND HOUSE STYLES TYPICALLY IN NEED OF REHAB

Victorian

Say "Victorian" and colorful scenes of pomp and sentiment come to mind, like a richly embellished greeting card of the times. Women in bustles and

bows twirl their parasols, strolling down the rose-covered walk in celebration of May Day at Oakland's Arbor Villa. Mustachioed men, their black bowler hats hung on polished brass hooks, mingle at the Forum Bar on Broadway. Slamming their mugs of Wieland Lager on the solid oak counter for emphasis, they extol the exploits of Sheriff Harry Morse who nabbed the notorious Narrato Ponce with the help of his ivory-handled six-guns.

Literally, the word "Victorian" describes an era of 64 years, the exuberant period from 1837 to 1901 when Victoria was Queen of Great Britain and Ireland, and Empress of India. Domestic arts and inventions thrived in her domain, but architecture flourished nowhere better during this period than in California. Here, the contagious optimism of gold rush and silver strike, wheat harvest and cattle round-up, was translated into physical expressions of prosperity. By the 1880's, the life of these aggressive pioneers assumed an aura of grace as the middle-class built themselves homes as spacious and spectacular as purse or parcel would allow. The building facade was embroidered with elaborately carved brackets and spindles, luminescent stained glass, and plaster-cast garlands. Inside, the parlor was filled, even cluttered, with fringed lampshades, draped flags, potted palms, patterned throw rugs, marble busts, and appliqued pillows proclaiming the virtues of religion, motherhood, and "Home Sweet Home." Life was spirited in late nineteenth century California, and the unrestrained taste in ornamentation proclaimed the excitement of the times.

Advances in technology went arm-in-arm with pronouncements of prosperity in prompting such individually expressive residential styles. The introduction of standardized lumber and machine-made nails in 1839 engendered a spectacular new construction technique known as the balloon frame. For generations, house construction required that hefty posts be positioned in the ground, with great difficulty, and that the cross-beams be joined to the posts, with great care, by the painstaking mortise-and-tenon technique. The framework was so sturdy that the building would stand by itself without the help of supporting walls.

In sharp contrast, the revolutionary *balloon frame*

utilized lightweight, pre-cut lumber instead of cumbersome timbers, and wire nails in lieu of hand-crafted joinery. Studs, the upright members, extend in one piece from the foundation to the roof, and joists, the horizontal members are nailed to the studs. The frame gets its rigidity from the siding or diagonal sheathing instead of from reinforced joints. The balloon frame, typically used for two-story houses, required only a facility with hammer, saw, and tape measure to construct, so the responsibility for house building was taken from the master carpenter and placed in the hands of ordinary, ambitious handymen. In fact, with the development of a variation on the balloon frame known as the *platform frame*—built one story at a time, with each floor serving as a platform for the next level of construction—it was quite possible for an entire structure to be erected by only two people. Platform frame construction is still used today.

The job was further simplified by the proliferation of house plan books which offered the novice or the merchant builder explicit architectural direction. Periodicals such as the *California Architect and Building News* motivated subscribers with the latest ideas for "tasty" residences, and provided them with floor plans and specifications.

When new machines were invented to mass produce elaborate building ornaments previously hand-hewn, house parts catalogs were distributed by the milling firms to promote and sell their products. By studying the illustrations the way farmers pore over seed catalogs, any builder could express his personal Victorian spirit by designing a unique composition of colonette and comice, balustrade and bracket, festoon and frieze. (Refer to the illustration of ornamentation vocabulary in Chapter 4.)

While the description of Victorian architecture sounds quite lavish, the fact was that between the balloon frame, the plan books, and the parts catalogs, handsome, well-constructed, and fashionably adorned homes were efficiently erected on a wide-scale for families of practically all income levels.

In Oakland, the flat and ample acreage afforded opportunities for building that the steep, narrow lots in San Francisco could not rival. The climate in the East Bay was far better suited to the Victorians' in-

terest in horticulture, and the abundance of inexpensive land here offered generous lots for the practice of gardening. A wealth of native trees shaded the avenues, while experiments with exotic plant material lent a distinctive tropical aspect to the growing Victorian neighborhoods. Visitors to the West would ferry across the bay and hire carriages to view the "elegant mansions and tasteful cottages" they had heard so much about as far away as New York. Even San Franciscans themselves would travel to Oakland to enjoy a sumptuous eleven course meal at the Grand Central Hotel or a bucolic Sunday picnic underneath the coast live oaks.

Oakland not only lured new arrivals with a striking physical setting. It offered its inhabitants cultural pursuits as well. In the 1870's, for example, the public library opened under the direction of Ina Coolbrith, California's first poet laureate; the State's first women's club, the scholarly Ebell Society, formed; the Chickering Club convened for amateur poetry readings; Snell's Seminary, one of the city's more select finishing schools, relocated from Benicia; and seven-hundred voices harmonized in a local choral group. How appropriate that Oakland Victorians inhabited house styles befitting their life and times: the expressive architecture of Italianate, Stick, and Queen Anne.

Italianate (mid-1860's-1880's)

Tall and stately, the Italianate house is a dignified neighborhood member in Prescott, Oak Center and Clinton Park, easily identified by its pronounced vertical lines. A two-story, slanted bay takes up about two-thirds of the front, and a raised porch with handsome portico fills the remaining third and visually balances the prominent bay. At the roofline, a projecting cornice is supported by concave, curved brackets, although the roof itself may actually be lower than this "false front" would suggest. In the past, cresting was the crowning touch, but most of this iron lace is long lost to metal salvage for post-Victorian war efforts.

Because the Italianate style is a California adaptation of stone structures built in seventeenth century Italy, certain architectural elements have been translated from stone into native redwood and

ITALIANATE

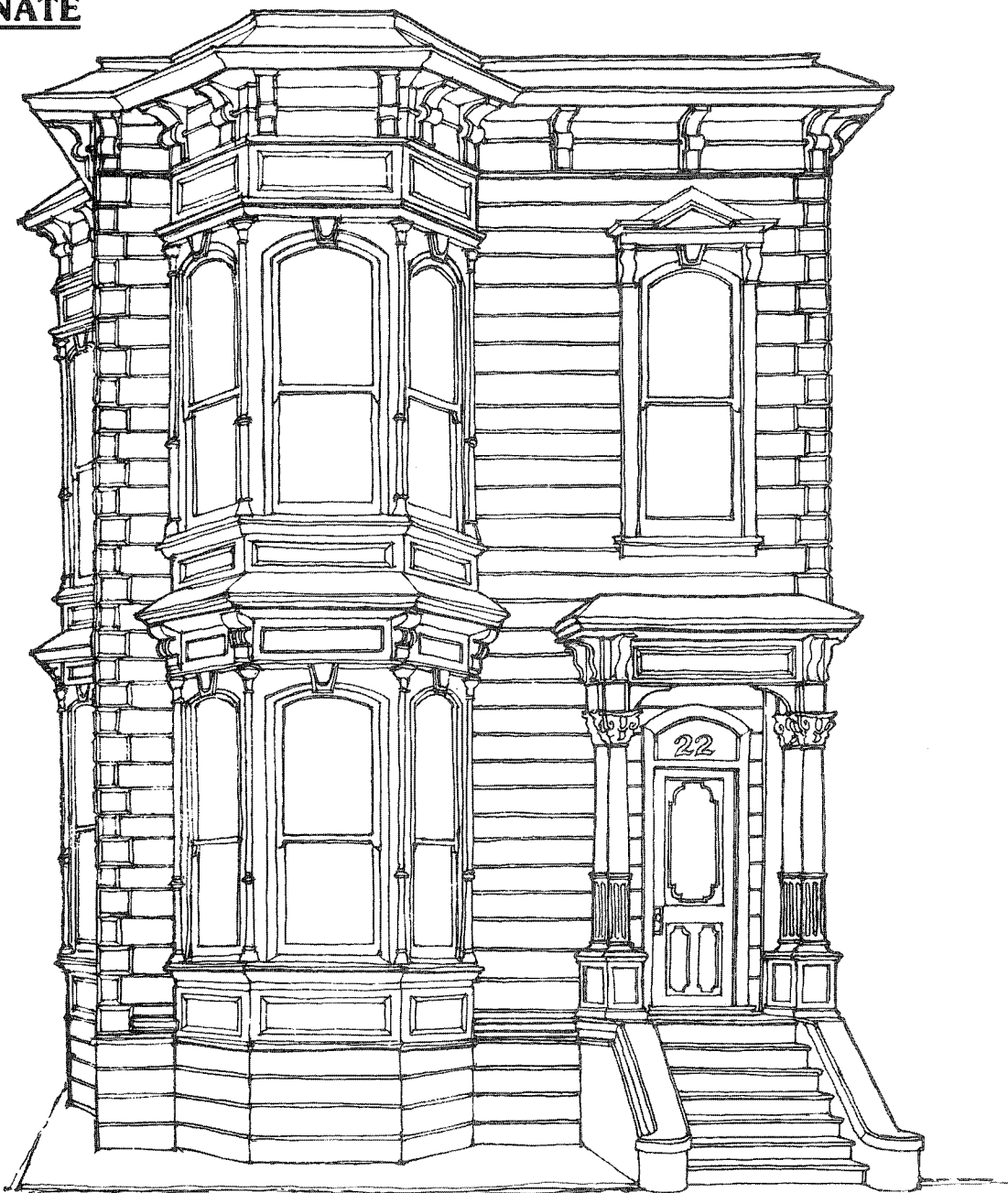

douglas fir. The square quoins at the corners of an Italianate house are decorative versions of the original masonry reinforcements, and the corinthian columns on the porch are carved from wood, not chipped from marble. Other imitation elements, such as brackets, panels, and keystones, communicate substance and stature critical to the successful appearance of the facade.

The windows on an Italianate house have a three dimensional quality that makes them resemble sculpture more than conventional panes of glass. Long and narrow, the measurements of the window and its many accessories are carefully proportioned to the size of the whole house. The shape, as well as the size, of the window frame, for example, is as graceful as it is distinctive: arched, notched or indented, it is rarely just rectangular. Slender colonettes to either side of the window, a protruding sill beneath, a decorative shield above, and a squeezed pediment, segmented hood or bay cornice to top it all off, turn the window into a spectacular event, not just something to look through.

The front door also reaches out to the street. Beginning with sculpted newel posts at the bottom of the front steps, the extended entrance continues right up the staircase with turned railing balusters to the partially fluted columns on the front porch. Overhead, a portico, which may in turn support another balustrade, shades the front door, itself much more than a flat, plain surface. The solid wood is divided into recessed rectangular panels, and the glass is cut for sparkling highlights.

Inside there is a long hall, with a series of doors. The first leads to the gentlemen's parlor, the second to the ladies' parlor with an additional bay window of its own, the third to the dining room, and the last, at the back of the house, to the kitchen. Within the rooms, arched passageways, reminiscent of the window shapes, provide a more formal transition from one space to the next. Sliding wood panels, solid and incised like the front door, close off the rooms for privacy as well as more efficient heating. Even the white fireplace picks up its decorative theme from the facade, with its mantel supported by curved brackets and its round, arched opening, just like the cornice outside.

SINGLE-STORY ITALIANATE



The ceilings are high, often twelve feet or more. To break up the expanse of wall, wood wainscotting or lincrusta-walton covers the first four feet from the floor. A strip of molding circumscribes the room at, or a foot or so below, the seam where wall and ceiling meet. Wallpaper, typically floral and sometimes garish, extends from wainscot to molding. These techniques make the tall rooms more in scale with the size of people. Some builders installed a coved ceiling instead of a cornice because it was a less costly design feature. The rounded corners give these airy spaces a comfortable sense of enclosure.

When you look up to see just how high that high ceiling is, you discover an elaborate plaster rosette,

some three feet in diameter, from which to suspend chandeliers. Originally the ceiling was wallpapered and the rosette was painted a rainbow of colors - the grapes purple, the leaves green, the roses rose. When your neck gets stiff and you look down, you find yourself standing on wall-to-wall carpeting with an Oriental rug on top. The Italianate room envelops you with things to see.

In Oakland, a smaller version of the Italianate house was also developed. A one-story building with front bay, bracketed cornice, pedimented window, simplified portico and raised first floor, the details are the same as the two story type, but the overall proportions are different. In San Francisco,

the heavy demand for real estate from the gold rush onward forced construction of tall, thin buildings which sometimes appear almost unnaturally elongated, but in Oakland the wider lots permitted such luxuries as side yards, side bays, and a local variant: the relatively short and broad Italianate house. Other variations found locally include a two-story Italianate with a one-story bay window, and a flat-front Italianate with no bay window at all.

Since the Italianate buildings date from as early as the 1860's, they have succumbed to many repair problems associated with old age. Prime victims of modernization, these once elegant Italianates are demeaningly concealed under pastel stucco or asbestos siding, mercilessly stripped of their brackets, colonettes and keystones, and thoroughly divested of their original character.

A striking example is found at the corner of 18th Street and Castro, where each in a row of five Italianate houses has a radically different appearance. The first and fourth have been left substantially intact, testimonials to their successive owners. The second has been modernized, or as some people say, "barbarized." Not only have the double-hung windows been ousted by sliding aluminum frames, but the window openings which were too tall for the conventional metal module have been reduced to suitable size by inserting a plywood flap. A once bold front door has been replaced by meek hollow core, and the handsome drop siding has been sheathed in salmon-colored asbestos shingles.

The third house has been mysteriously transformed from an Italianate row house into a Spanish villa. With the whimsy of Walt Disney, some carefree remodeler trowelled the house with white stucco, roofed it with red tile and planted thorny triton cactus right in front. The fifth Victorian house is, alas, just a memory. It was demolished in favor of the drab concrete box built in its place.

San Francisco Stick (late 1870's-1890's)

The San Francisco Stick Style, as its title suggests, originated across the Bay and emphasizes straight lines and right angles. Flat, narrow boards are nailed to the outside of the building to boldly repeat, and blithely reinforce, the structural skeleton

SAN FRANCISCO STICK



beneath the clapboard skin. Diagonal braces, installed parallel to the facade instead of projecting from it, frame the porch. The roof projects over the front of the house so that the gable end forms a separate plane. Its composition of right triangles, incised with sunrays and starbursts, casts a shadow on the facade behind.

The structure of the San Francisco Stick house communicates lines and right angles in a more subtle way than the ornamentation does. A rectangular bay window, which also happened to be easier to construct, replaced the slanted bay window of its Italianate predecessor. The straight roofline of the earlier style was bent into a gable that creates the illusion that the sides are perpendicular. The horizontal siding is reoriented to vertical and diagonal positions, especially around the bay window where the structure is exaggerated by the board and batten technique. Furthermore, the square tower first appears.

At last, by the late 1870's, builders were treating wood as wood. For a decade before they had used wood as a medium to imitate stone in the adornment of Italianate houses. The two-dimensional design of the Stick decoration was a product of scrollsaw and jigsaw—the same tools which introduced those intricately carved puzzles for Victorians' entertainment. Local redwood and Douglas fir offered seemingly inexhaustible supplies of high quality timber with clear open grain that did not split or splinter when nailed. Surprisingly, the price of redwood remained relatively constant through the turn of the century, despite the increase in demand, a brief period of inflation, and a duty on foreign trade which could have easily encouraged a competitive rise in domestic lumber rates.

A decorative variation to the San Francisco Stick style, known as "Eastlake," carried the exploration of the properties of wood one step further to the three-dimensional. Knobs and newels, turned out by chisel, lathe and gouge, and most closely resembling table legs, typify this architectural mode mistakenly named for British designer Charles Eastlake.

Seven years after the publication of Eastlake's book *Hints on Household Taste*, a treatise eschewing

excessive decors in favor of more "chaste and sober designs," the Londoner's work was displayed at the 1876 Centennial Exposition in Philadelphia. His furniture was straight and square, its flat surfaces impeccably pierced with abstract floral or geometric patterns. Builders and architects, quick to catch on to the latest fashion, applied Eastlake's cutouts directly to Stick houses. But soon the ornamentation assumed a life of its own, and the simple, chaste designs evolved into sculptured, almost voluptuous, decorations. Flowers and foliage, columns and spindles, as shapely as the contemporary hourglass corset, came to be known as the "Eastlake Style." Needless to say, the sombre Briton was appalled at the application of his name to such chicanery. "The specimens I have seen illustrated," he wrote regarding the architectural version of his once simplified standards, "burlesque such doctrines of art as I have ventured to maintain."

When explosive Eastlake motifs are found combined with the straightforward San Francisco Stick Style, the result is often referred to as Stick-Eastlake. However, extensive research by Judith Waldhorn and Gary Kray reveal that there is very little to differentiate the actual building design of houses with stick and/or Eastlake adornment. Even though some of the exterior ornamentation may be repeated inside—diagonal braces or spindles on archways, for example—the plan itself is usually reminiscent of its Italianate precursor, and provides inconclusive evidence for a separate Eastlake or Stick-Eastlake category.

President Herbert Hoover lived in a modest, two-story Stick house with fancy shingles and a spindled arch on Twelfth Street, near Chestnut, when he was an office boy here in 1896. That house probably cost \$2500 to construct. Julia Morgan, the prolific architect whose own work will be mentioned in later sections on the Craftsman Tradition and Period Revival, grew up in a more lavish Stick home at the corner of Brush and 14th Street, a residence which showed elements of Queen Anne architecture as well. Perhaps the best Oakland example of the San Francisco Stick style is the Alfred Cohen house on the east side of 29th Avenue just above East 14th Street. Obscured by overgrown trees, it is easy to overlook. Stick houses are also

found in West Oakland where Ninth Street and Chester intersect, on 15th Street, east of a Grove Street warehouse, nestled between modern apartment buildings on the ridge above Grand Avenue, and quite by coincidence, East-of-the-Lake.

As the eighties approached, the urge to combine architectural styles was encouraged. Stick and Eastlake features were enthusiastically incorporated in the Queen Anne style which soon followed.

Queen Anne (1883-1890's)

When an 1883 issue of *California Architect and Building News* introduced what came to be known as the Queen Anne style to the Bay Area, it marked a dramatic departure from the rigorously vertical Italianate and San Francisco Stick style houses. The Queen Anne house is certainly more horizontal in appearance, but more important, it is an absolute concoction of volumes and textures. Round corner towers with peaked witch's caps intersect steeply pitched gables with applied sunbursts. Recessed upstairs balconies with turned balustrades overlook prominent front porches trimmed with arched lattice-work. The arrangement of forms appears haphazard, and the assortment of surfaces is totally unrestrained. Horizontal bands of masonry, scalloped shingles, colorful tiles—or stucco made to look like tiles, carved wood work, plaster garlands, and "artist's glass" mark an irregular progression of stories from foundation to oriel to attic. There is no single roofline, but a picturesque composition of merging shapes. Nor is there a single window pane: the upper portion of each double-hung window is surrounded by small squares of flashed glass. And if there still wasn't enough color, two pieces of glass would be installed together to create the hue of a third.

If the Italianate house is like a svelte, prim dandy standing at attention, his frilled cravat spilling over velvet lapels, then the Queen Anne house is like a buxom gypsy, her ruffled skirts, billowing blouse and patterned kerchiefs infinitely artful, but always in disarray and never quite matching. Despite the discrepancy between the two images, both styles are expressive, even extroverted, in true Victorian spirit.

QUEEN ANNE



QUEEN ANNE COTTAGE

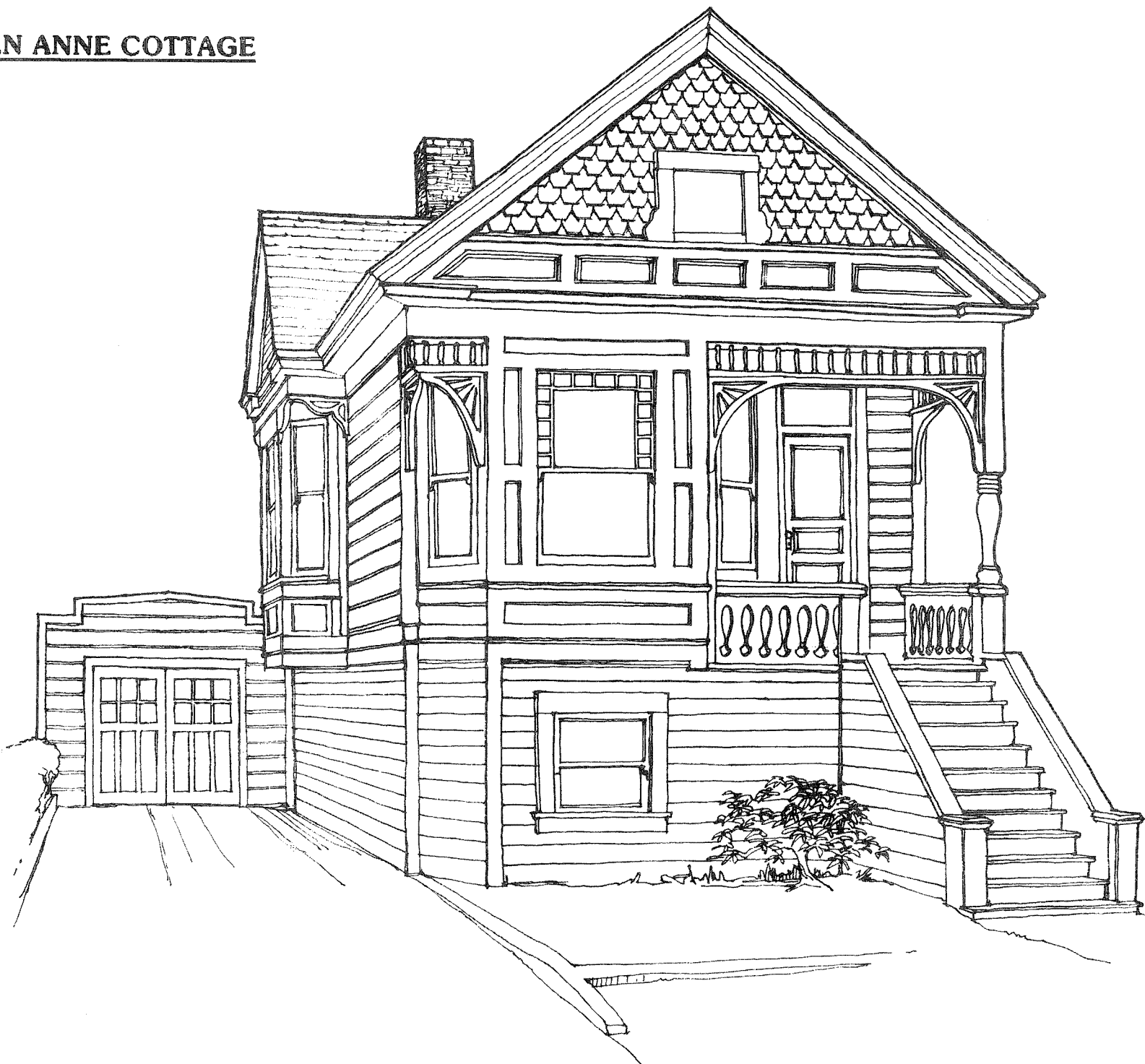

The striking change in image was eased by central heating, admittedly more important in the East. There, by the late 1870's, it was no longer necessary for rooms to be shut off to keep the heat in and the cold out, so the circulation pattern was not constrained to long corridors with an endless series of doors. The influence spread westward, and here too the Queen Anne has a grand hall at the heart of the house—a symbol of gracious living—and the rooms radiate out from the central core. Rejecting the strict lines of the Italianate and San Francisco Stick floor plan, the interior spaces in the Queen Anne house flow from one to another, with dimensions as irregular as the exterior silhouette suggests. Sometimes a freestanding staircase rises like an island in a two-story high living room; sometimes an inglenook provides a cozy recess next to the fireplace with a comfortable bench for reading and rest.

Derived from the rambling manor houses of British architect Norman Shaw, the Queen Anne style was popularized under the banner of “picturesque.” Style books, like *Palliser's*, magazines like *Harper's*, and essays, like those of Andrew Jackson Downing, promoted the picturesque mode as the pinnacle of good taste. It was most desirable, even democratic, to design a building whose informal arrangement of forms and textures communicated a “wild ruggedness.” Asymmetric patterns, emphasizing shape, light and color, were the calling cards of domestic design.

In the San Antonio District, a rhythmic progression of tower houses marches up 23rd and 24th Avenues, from E. 21st to E. 27th Street. Some of the towers are enormous cylinders, almost like silos. Some are prism-shaped turrets perched high on the corner, making the house resemble a mid-eastern spicebox. Other towers are simply rectangular in shape. A neighborhood collection of tower houses like this is exceptional, an architectural resource that few cities other than Oakland can point to.

In the 1880's, a rowhouse version of the Queen Anne style popped up in cities nationwide from Boston to San Francisco, adapting the popularity of the picturesque to a broader range of budgets. In Oakland, it had been over ten years since the completion of the transcontinental railroad married

the East Bay to the rest of the country in 1869. The demands of a growing population for new housing were accommodated by a proliferation of Queen Anne cottages. You'll find their giant gingerbread gables city wide: in North Oakland, west of Telegraph Avenue, in West Oakland near McClymond's High, in San Antonio near Foothill Boulevard, and in Chinatown around Madison Square.

The Queen Anne Cottage is a one-story building practically consumed by an oversized gable. A veritable billboard for textural effect, the ornate gable may be clothed in decorative shingles, framed with intricate bargeboard, pierced by flashed glass windows, stamped with a sunburst, and topped with a proud finial. A less elaborate gable might only have scalloped shingles, a perimeter of dentils, and a modest topknot. The Queen Anne Cottage is very common in Oakland, and can be seen in a row on Harrison at 29th Street, as an antique store on College near Clifton, and sprinkled along 97th and 98th Avenues between Bancroft and East 14th Street, and scattered throughout San Antonio and Clinton Park.

The gable overwhelms the front bay window, and this arrangement of volumes creates cut-away corners and a recessed porch. For each of these new architectonic features, special ornamentation evolved. At the corner, spindled brackets support the overhang, and a pendant—a turned, wooden tear drop, the opposite of a finial—punctuates the projection. The porch has a circular arch (Queen Annes show a fondness for circular forms) which reaches from the bay window to rest on a single column. The column represents no single motif, but, like the Queen Anne itself, is a mixture of styles, as its beaded base, truncated shaft and ad-hoc capital indicate. In fact, the Queen Anne style is such an unabashed composite of borrowed elements that it behooves the owner to read the other sections in this manual on Victorian types as well.

The floor plan of the Queen Anne Cottage is not as palatial as the countrified Queen Anne style. The limitations of rectangular urban lots and workingmen's budgets combined to condense the sprawl of gables and turrets into a more succinct package. The grand central living hall is reduced to a modest

vestibule, but there is still no corridor. The rooms are arranged in succession like Italianate or Stick, but the spaces merge together through spindled archways.

In some cases, Queen Anne Cottages were built by speculators who advertised them as a wise investment because the one-story structure had a built-in option for expansion: the attic under the gable. In other, more select situations, architects designed Queen Annes. Examples of the collaborative work of the brothers Newsom, prominent California architects of the time, still stand in “Brooklyn,” that section of Oakland incorporated in 1872 and now known as Clinton Park. Look for one on the southeast corner of East 18th Street and 10th Avenue, and another on the southeast corner of East 23rd Street and 9th Avenue. In 1890, the same year that his plan book was published with instructions for a “suburban style suitable to Oakland,” Samuel Newsom cheerfully announced: “Nowadays, beauty . . . is becoming happily less and less of a luxury.”

Colonial Revival

As the 19th century drew to a close, and the gaiety of the nineties subsided, the nation's homebuilders, almost penitent for their Victorian excesses, looked toward an architectural style more refined than the bombastic Italianate and more orderly than the quaint Queen Anne. Things European lost their snobbish allure as the new world filled with working class immigrants, and Americans turned to their own country's history in search of an architectural image.

The New England exhibit at the 1876 Philadelphia Centennial Exposition sparked the nostalgia. Then, with improved train service, people began to travel for pleasure, discovering in Massachusetts and Rhode Island the charm of colonial houses “mellowed in place as nothing else in America seemed to be.” The colonists' homes were rich in elements derived from the Greek and Roman humanistic tradition: symmetrical facades, floor plans, and sensitive proportion. Known as “Georgian,” “Federal” or “Adam,” and “Jeffersonian,” the various styles built between the Revolution and 1820 were typified by their classic columns, prominent porticoes,

molded geometric patterns in low relief, rectangular windows with small panes of glass, and a semi-elliptical fanlight over the front door. These features were easy enough to imitate with the materials and technology available a century later. The Colonial Revival was on.

The 1893 Columbian Exposition in Chicago clinched the neoclassic trend. Beaux-Arts architecture, named for the Parisian design school which professed Greek and Roman precedents, was the theme of the world's fair. For years thereafter, everything from public monuments to office buildings to single-family residences picked up the classic features—capitals, pediments, colonnades, etc.—that bespoke a civilized culture.

Meanwhile, back in Oakland, major streets were suddenly striped with parallel metal tracks, and the air literally buzzed. The electric trolley had arrived. Along Grove Street in 1889, along Piedmont and East 14th Street in 1892, along Telegraph, San Pablo, Broadway, Foothill, and numerous others in subsequent years, the electric trolley brought the blessing of efficient transportation to the City, and with it, a halo of development. Business enterprises lined the trolley route, genesis of the commercial strips which cling to those thoroughfares to this day.

On the side streets, in a grid pattern perpendicular to the electric cable, Colonial Revival houses sprung up, like mushrooms which feed on a tree's roots, boldly tracing the roots' clandestine pattern above ground. In return, the mushrooms provide nutrients to the host tree, and similarly, the trolley's existence depended on ample patronage from the very development it created.

The wealthy built Colonial homes of grandiose proportions. In the East Oakland foothills, the Dunsmuir House stands as an impressive example of neoclassic architecture. Its white doric columns, majestic pediment, and parade of roof balustrades have such an air of mystery and romance that this landmark has been used as a movie set, most recently for the film *Burnt Offerings*.

Another large Colonial Revival building can be found at 7th Avenue and East 18th Street. It has a substantial pediment supported by two-story high Ionic columns, sidelights flanking the front door,

CLASSIC BOX



and a protective brick wall with cannonball topknot defining the yard. But its modern use is much less exclusive than that of the Dunsmuir mansion: this is a boarding house.

For the average family, the separation of work place and residence was at last a convenient reality, so several simplified versions of the Colonial Revival were designed to suit their needs. The subdivision of residential land near the trolley lines was noted for its narrow street frontage which coincidentally minimized the distance from front stoop to car stop. What the lot lost in width it made up for in depth, and a long shoe-box shaped building was the architectural response. Architectural historian Sally Woodbridge has dubbed this style the Classic Box. For lack of a more formal designation, we call the other workingclass styles the Neoclassic Rowhouse and Eastern Shingle Cottage. These houses exhibit neoclassic details, although their form maintains obvious hold-overs from the Queen Anne Cottage, like the raised basement, recessed porch, and bay window.

The Colonial Revival style was more popular in the East Bay than in San Francisco, but in general was short-lived in California. It just didn't fit in. Charles Keeler, in his 1904 book *The Simple Home*, harangued "the meaningless white-painted fluted columns of hollow wood" as "wholly incongruous in the glare, newness and rush of western life." In response, Californians directed their attention to the State's heritage in search of a style more attuned to the local light and landscape. The California counterpart to Colonial Revival became the Mission Revival, although few, if any, residential examples exist in Oakland.

Despite its brevity, the few years of popularity enjoyed by the Colonial Revival style coincided with a large demand for housing. The Oakland population tripled from 48,682 in 1890 to 150,174 in 1910. Urbanization reached out along the fingers of the electric trolley lines, reorganized and greatly expanded in 1902 as the Key System under the strong hand of F.M. "Borax" Smith. And the City boasted the lowest death rate in the entire world! Less than thirteen mortalities per thousand inhabitants for the twelve year period between 1886 and 1898. Thus, the large number of Classic Boxes and

Cottages found in Oakland belies the limited period Colonial Revival was fashionable in California.

Neoclassic Rowhouses are quite common in North Oakland. The trolley, after all, spread its influence up Grove Street, Telegraph, Claremont, and Shattuck. You'll recognize examples of this style along Temescal Creek, near Bushrod Recreation Center, and by Mosswood Park. The rowhouses are sited close to the sidewalk on fairly narrow sidestreets, like Locksley and 58th Street. There is but a patch of front yard wedged between the prominent front steps, the sidelong driveway, and the paved-in planter strip. Obviously the very urban Colonial Revival style was not known for its integration with nature. In fact, this was the last hurrah for formality because the earthy First Bay Tradition followed soon thereafter. The Eastern Shingle Cottage provided the transition.

Classic Box (1890-1910)

It's not a very appealing name, Classic Box, but it certainly is descriptive. A two-story structure, resembling a Kinney shoebox in shape and a roman temple in detail, this style is typical to West Coast cities which experienced a burst of population growth at the turn of the century—Seattle, Portland and Oakland. Don't think of the "box" as an unimaginative geometric shape. Consider it, instead, a creative response to site constraints and fashionable trends. The Classic Box pulled in its wings in contrast to the spread eagle posture of the Queen Anne. The parts of the house were retracted into an orderly package, with flush planes, flattened ornamentation, and few protruding parts. Even bay windows, when they exist on the side or front, are compressed, a broad angle minimizing the distance of the projection.

At the same time, the rectangular layout recalled the floor plan of the colonists' homes they had set out to imitate. The earliest settlers in the 17th century had designed the first American dwellings no more than one room deep under the main roof. The more sophisticated Colonial style which soon followed, and persisted as the most common style in the 18th century, was just as wide, but twice as deep. Called "double-pile," this floor plan consisted of two rows of rooms, broadside facing front.

Reinterpreted a hundred years later in Oakland, the long, narrow lots demanded that the double-pile plan be reoriented, with the short end addressing the street instead.

Typically, the front door is on one side, leading to a foyer devoted to a "U" or "L" shaped staircase sporting two knobbed railing balusters per step. The stairway landing, bathed in pastel light from the stained glass overhead, boasts a built-in bench whose hinged top reveals a hidden storage bin. Behind the foyer there's a closet, then a bathroom, and at the back, the kitchen. On the flip side of the double-pile plan, the living room, dining room and wash porch are lined up.

Colonial Revival details include hefty ceiling beams, waist-high wainscotting, and classic columns in the archways—all in a dark finish. This was the period when hardwood floors came into their own, and the regularity of the floor plan was emphasized by the parquet border inlaid around the perimeter of square rooms. A plan book published by the Pacific States Savings, Loan and Building Company around 1900 offered an elegant but economical ten-room house that we would call a Classic Box. Its construction cost? Only \$10,000.

The Classic Box is capped by a broad peak. A dormer window sticks its head out from the middle—a hipped roof within a hipped roof. At the cornice, the eaves are usually enclosed, either a shallow relief of plaster patera or swag garlands on the frieze. Patera are abstracted petals in concentric circles. Swag garlands are carved compositions of fruit and flowers, draped like a piece of cloth over two supports, and "tied" with plaster ribbons. Also known as festoons, the garlands sometimes appear in a band between the first and second story. While this decoration recalls Victorian ornament, other variants of the Classic Box anticipate the Craftsman era. On these later versions, the eaves are no longer enclosed, and the exposed rafters constitute decoration derived directly from structure.

There is great variety among window shapes on a single Classic Box. The dormer window is short and broad, like a winking eye. The double-hung windows on the facade have a squarish appearance, and on some, the upper portion is partitioned into

CLASSIC BOX



eight smaller panes, akin to its colonial ancestors. The window arrangement is fairly symmetrical in front, but on the side, windows of assorted size are scattered chaotically across a large page lined by slender, clapboard siding. Some of these windows are as small as twelve inches by eighteen inches; some are stained glass; some have diamond-shaped leaded partitions and do not even pretend to open. Despite the discrepancies, every window in a Neoclassic Box is invariably framed by a wide strip of flat, wood trim.

Colonial Revival houses are known for Palladian windows, and these appear on selected Neoclassic Boxes in Oakland. A Palladian window has three parts: a high arched central section, and, on either side, a lower section underneath an entablature. This distinguished feature is named after its designer Andrea Palladio, Venetian architect of the Italian Renaissance. In the 17th century he revived the use of classical forms and proportion, and his work has been imitated ever since. Look for a Palladian window on the Claremont Avenue apartment building next to Hardy Park and the professional offices that overlook Lake Merritt near Perkins Street.

Other classic details of this residential style may have Palladian origins too. Hugging the corners of the house are fluted pilasters. Pilasters are like columns, having a base, shaft and capital, but pilasters are flat instead of round or square. The front door is enshrined beneath a portico complete with Ionic or Corinthian capitals. When the portico is flat, it is topped by a turned balustrade, and sometimes the portico extends across the house, creating a spacious front porch. In other homes, the portico is peaked and hipped, repeating the theme established by the roof and dormer. Even the front steps are in keeping. The tread and risers are flanked by a terraced stoop, each level covered by a flat, overhanging cap.

Originally, Colonial Revival houses were painted white or subdued tones of gray, with white trim and black window sash. Some modern owners, jumping on the Victorian paint wagon, have chosen to highlight details with bright, contrasting colors. As successful as this technique is for extroverted Italianate and San Francisco Stick houses, it is of ques-

tionable value for the more sedate neoclassic style. Another dilemma faced by contemporary occupants is the lack of off-street parking. Classic boxes were designed to fill their narrow lots, and besides, they were built for riders of mass transit.

Neoclassic Rowhouse (1895-1915)

Not every family needed a ten room home. A smaller East Bay residential style which grew out of the Colonial Revival genre is the Neoclassic Rowhouse. A one-story house on a raised foundation, with a hipped roof and dormer window, the Rowhouse shares many classic details with its brother the Box. Its form, however, is more reminiscent of its forebear, the Queen Anne Cottage. Although "rowhouse" suggests attached units, it is used here to mean detached houses built side-by-side, in a line.

The front portico that is so pronounced on the Neoclassic Box is absorbed within the rectangular perimeter of the Rowhouse. The front door is recessed to one side. On the same corner, the large peaked roof reaches out over the door, and rests on one, two or three classical columns. The columns are abbreviated, resting as they do on a three-foot high wall which encloses the porch and accentuates the squared-off plan. The character of the columns varies from house to house. They can be square and chunky with Doric features, or turned and slender with simplified Ionic capitals. On remodeled Neoclassic Rowhouses, the columns are often camouflaged in asbestos siding, or replaced by curlicued wrought-iron supports. In some cases, the porch and its columns have been eliminated altogether, walled-in and weatherized to create more interior living space.

Alley-like sideyards are the result of narrow lots. Designers of the Neoclassic Rowhouse were forced to capitalize on the front and the back of the house for natural light. On the street front the living room had a slanted or square bay with double-hung windows; in the rear, there is an airy sleeping-porch. Where space allowed, a modest bay projects into the side yard, the way an elbow sticks out when your hands are in your pockets, no matter how close you hold your arm to your body. Notice the difference in proportion between the broad and

austere bay window on the Neoclassic Rowhouse, and the elaborate and elongated bay window on the Italianate.

The dormer window plays an important part in visually breaking up the roof and venting the structure, but it does nothing to supplement the supply of light. Behind the dormer is an attic space rarely converted to living quarters. It is not surprising, then, that when the glass in the dormer breaks it is replaced with plywood or odd-lot lumber.

Like the Box, narrow white clapboard covers the Rowhouse, wide, flat trim frames its assorted windows, and a terraced stoop flanks the front steps. Since the main floor is raised as much as ten feet

from the ground, it can present a long climb to the front door. For safety purposes, most steps have supplemental railings that were not a part of the original building. A railing design sensitive to the colonial motif is graduated like the steps themselves. The more common, hardware store solution is a straight wrought-iron rail installed on the diagonal, but its appearance is jarring.

The raised main floor creates opportunities for in-law apartments, rental units and garages underneath. Tempting as this extra space is, efforts to utilize it are often accompanied by violations of building or planning codes. Similarly, the handyman, beckoned by the dormer window to expand

NEOCLASSIC ROWHOUSE



into the attic, faces legal constraints pertinent to family safety. Before invading the attic or basement of your Neoclassic Rowhouse with an army of tools and good ideas, check with the Inspectional Services and Housing Conservation Departments. (Their services are described in more detail in Chapter 3.)

Eastern Shingle Cottage (1895-1910)

The Eastern Shingle Cottage is so named because its A-frame shape and shingle surface are holdovers from a larger, east coast style. Its details, however, are strictly classic, and firmly in the Colonial Revival tradition. In fact, close examination shows that the ground floor of the Eastern Shingle Cottage is almost identical to the Neoclassic Rowhouse: a raised first story, a recessed front porch with classic columns, and a bay window to one side. But the second level is astonishingly different. A gigantic gable twice as tall at its apex as the height of the first floor, and as wide as the house itself, dominates the scene.

The front and sides of the gigantic gable meet at a perfect seam. If this were more of a Craftsman house, the eaves would extend beyond the face of the gable, and the supporting beams would be exposed. The concealed structure and flush edges are among the reasons the Cottage belongs in the Colonial Revival category instead of the Brown Shingle Style, despite its frequently brown shingled surface.

The gable is pierced by one or two windows, which are surrounded by broad, flat trim. This is similar in spirit to the attic window which interrupts the hipped roof of the Neoclassic Box because emphasis on the window compensates for the ungainly expanse of the roof plane. Several design techniques are used to accomplish this. On many examples, the double-hung window is underlined by a wood railing with closely spaced balusters. The function of the window and railing composition is to complement the proportion of the enormous isosceles triangle in which it sits. Unfortunately these railings are often removed when new siding is installed. The window has no visual anchor without it, and the gable looks miserably empty.

EASTERN SHINGLE COTTAGE



On other examples, the window sill is exaggerated and supported by protruding brackets, something like a pouting lower lip. On still others, the window panel is recessed within the gable, and the shingles curve inward to meet the sash.

On the side of the house, which is to say on the side of the gigantic gable roof, there is a large dormer-like projection with several double-hung windows. A dormer is a window placed vertically in a sloping roof, with another sloping roof of its own. The name derives from the French word "dormer" (they pronounce it door-may) which means "to sleep" because the space the dormer window af-

fords usually serves as sleeping quarters. Sure enough, in the Eastern Shingle cottage this feature is the upstairs bedroom.

Architect Ernest Coxhead, an English expatriate, practiced in the Bay Area during the Colonial Revival period. His rather eccentric designs for churches and residences are characterized by an over-sized gable for the roof, sheathed with shingles and punctured by carefully placed windows. His influence on the merchant builders who distributed the Eastern Shingle Cottage throughout Oakland and Berkeley is obvious.

First Bay Tradition

There's a saying that "history repeats itself" and when it comes to architecture this conventional wisdom really applies. For "revival" styles, the home builders of a particular era look to historic forms for inspiration and imitation. In "germinal" or original styles, a new building aesthetic is established which will someday be copied by future designers.

The First Bay Tradition, as the name suggests, was the beginning of a regional style which was destined to reappear. It emerged in the 1890's, developed for the next 25 years or so, and peaked in the mid-1920's when over 14,000 bungalows were erected in East Oakland. The Second Bay Tradition began in the thirties, and for its duration urban residences resembled rural California farmhouses. As development moved upward into the hills, post and beam construction was reinterpreted to accommodate the steep slopes and incorporate the panoramic views. By the Third Bay Tradition in the sixties, the redwood sheathed vertical box was in vogue, with vocabulary borrowed from the tract builder's language.

The First Bay Tradition is characterized by its communion with nature, sensitivity to basic materials, appreciation of structural form, and demand for fine craftsmanship. Sound familiar? These very tenets are repeated one more time in the Back-To-Earth Movement of the seventies. Because more Oakland houses fit into the First Bay Tradition than any other category, our city has the unequalled resource of an older architecture that is "in" by contemporary standards.

The redwood, the exposed beams, the built-in bookcases, the informal floor plan, have tremendous appeal to a new generation of homebuyers seeking natural quality for their living environment and financial investment.

Four architectural styles constitute the First Bay Tradition, and they fit in two subcategories: Craftsman and Prairie. As we found with other Oakland styles, there seems to be a small and large version of each. The Craftsman Bungalow is a more mod-

est expression of the Brown Shingle home. The California Bungalow is like a compact counterpart of the winged Prairie Style.

While house trends in the Victorian era were established by merchant builders, the First Bay Tradition derived from the work of professional architects. Although only a rare reader will own a house designed by one of the great masters, their influence is seen in so much of Oakland's architecture that they deserve mention here.

In 1869, Joseph Worcester, Swedenborgian minister, left Boston for San Francisco, and brought to the Bay Area the transcendental teaching of Ruskin, Emerson and Thoreau. "The most beautiful styles of art and architecture," they wrote, "are those that closely imitate the forms of nature." As a physical statement of this design philosophy, Worcester built himself a house in what was then an unfashionable section of Piedmont, a rough-hewn cottage constructed entirely of unfinished redwood, inside and out. Imagine what a striking departure this reserved and rustic bungalow was from the highly ornamented and ostentatious Victorian homes of the same period (1876).

By the 1890's, the Bay Area enjoyed a poulation of well-educated architects. Each picked up the thread of Worcester's plea for the unaffected and wove it into a new architectural fabric. A. Page Brown, A.C. Schweinfurt, Willis Polk, Bruce Porter and Bernard Maybeck collaborated on the design of Worcester's house of worship. The Church of New Jerusalem (2107 Lyon Street, San Francisco) is a masterpiece of serenity, and a milestone in the First Bay Tradition for its consistent use of hand-crafted natural materials.

The influence of Worcester on the work of Ernest Coxhead, John Galen Howard, Louis Mullgardt, and Julia Morgan was less direct, but the outcome was similar: an architecture of shingles, stained wood, exposed rafters and picturesque spatial arrangement.

Despite similarities, there was no formula. Each architect pursued a personal building style. Polk's work was flamboyant, Schweinfurt's was primitive,

Coxhead's was wry. Of them all, Maybeck best embodied the Arts and Crafts attitude because he participated in the construction process when the blueprints left the drawing board. Woodworker, stonemason, post-painter, Maybeck has become something of a folk hero in the Bay Area for his unrelenting commitment to fine craftsmanship. The many examples of his residential work which can still be discovered in the middle and upper class neighborhoods of Berkeley and Oakland offer a rallying point for architectural groupies.

The famous architect Frank Lloyd Wright was a contemporary of the First Bay Tradition design circle, and despite the two-thousand mile distance from Wright's home base in the midwest, his influence was felt here in Oakland in three ways. First and foremost, Wright "invented" the Prairie Style house. According to *A Guide to Architecture in San Francisco and Northern California*, "With the exception of Chicago, there is no urban community which contains as many examples of the Prairie Style (as the Oakland-San Francisco metropolis)."

Secondly, Wright trained several architects, among them A.C. Schweinfurt, Frederick Langhorst, and Aaron Green, who later came to California to achieve prominence and contribute to the evolution of the local genre. Third, Wright was imitated by Bay Area practitioners in all three phases of the regional tradition. The gently sloping roofs, low proportions, sheltering overhangs, and indigenous materials which typify Wright's style were incorporated in the work of architects John Hudson Thomas in the teens, William Wurster in the thirties, Lois Langhorst in the forties, Charles Callister and Jack Hillmer in the fifties, developer Joseph Eichler in the sixties, and countless other Bay Area building designers throughout the twentieth century.

The preceding paragraphs may read like a telephone book, there are so many names mentioned. But the point is a simple one. The architecture of the First Bay Tradition in Oakland displays an unusual design awareness for homes built by contractors, and this can be attributed to the Tradition's origins in the work of talented, professional architects.

BROWN SHINGLE



Brown Shingle (late 1890's-1915)

The spacious, two-story Craftsman house is called either Brown Shingle or Western Stick Style. These interchangeable names are as straightforward as the style itself. They are no-frill descriptions of the building's trademarks: the redwood shingles, weathered to a raisin-brown, and the projecting structural members, elongated and exaggerated sticks. This frankness was hardly the case in the Victorian era when the houses were so decked-out that they earned pretentious names derived from European dignitaries.

A Craftsman house was once cleverly described as "looking more natural than nature itself." The characteristics of the Brown Shingle style justify this quip. The shingles cover the entire house like bark on the trunk of a tree. They bend where the building bends and bulge where the building bulges. On a beautiful example in Pill Hill (384 34th Street), the shingles form a hood over the window, circling it the way that cambium encases the bole when a bough is removed.

The shingles are typically two feet long and eight inches wide, paper thin at the leading edge and nearly half an inch thick at the base. Because they overlap to keep out the rain, the shingles look more like horizontal rectangles than vertical ones, once installed. Many Brown Shingle houses are shingled in a manner which looks as if each slat is a double image. In reality, the broad and narrow bands are all the same size shingle, but the spacing varies to create the pattern.

Shingles change color with age and acquire a rich patina that is desirable, even sought after, but in some cases they do look shabby. To freshen up shingles, use stain, never paint. Paint harms natural shingles because it clogs the pores. Water collects with no way to evaporate, and accelerates decay.

The word "stick" was used in the 1880's to describe the flat boards applied to the facade of Victorian houses to echo the structure underneath. Here, too, the stick work is a structural expression. While the Victorian stick style capitalized on the ornamental opportunity the stick work afforded, the Craftsman stick style emphasizes the structure itself.

The tie beams, for example, are not concealed within the roof, but extend beyond the eaves into plain view. The protruding end of the beam is finished with a simple diagonal cut, a set of notches, or a Swiss or Japanese motif. Braces are attached to the gabled end of the house to support the heavy rafters. Constructed like a right-triangle, each brace is finished with a slash, a notch, an Alpine cut-out, or an Oriental twist, like the beam itself. Between the braces and the broadly pitched roofline, a bargeboard is added, a sturdy two-by-twelve, from the days when lumber dimensions were literal, and "two inches" did not mean "one-and-five-eighths."

Living and sleeping porches are an essential feature of the Brown Shingle style not only because they obscure the threshold between indoors and out, as the Craftsman credo commanded, but also because they provide another stage for stickwork. Porch posts often stand in pairs—two sticks are better than one—and the horizontal framing members project a foot or more beyond the posts. Many a veranda is covered by a trellis, and what is a trellis but the barest skeleton of structural form? Even the choice of wisteria as the vine which is typically trained over the trellis cooperates with the overall image. In warm seasons, wisteria may camouflage the trellis with its profuse foliage or upstage the stickwork with pendants of lavender blossoms, but as winter approaches the vines lose their leaves, and the structure prevails.

The incorporation of plants into the architectural form is but one way Craftsman style houses use natural materials exclusively. Shingles and shake, rough stone and redwood were acceptable, trimmings were unnecessary, and oil paint generally frowned upon. According to the Hillside Club, early East Bay conservationists and arbiters of taste, "No colors are so soft, varied and harmonious as those of wood." Despite this, or perhaps rising to the challenge, Bernard Maybeck developed his own palette of Pompeii red, blue-green, salmon and beige which were, in fact, soft, varied and harmonious with wood.

The chimney is made of clinker brick, a brick more coarsely textured than the conventional type because it has been overfired in the kiln. Originally discarded seconds, clinker bricks became so pop-

ular that correct overfiring became a craft in itself. Outside, the dark red clinker brick blends well with the grooved shingles and redwood grain; inside, the clinker brick fireplace is the visual focus of the living room and the symbolic focus of the home. Gustav Stickley, editor of *The Craftsman Magazine*, a periodical which monitored craftsman-like lifestyles with a religious fervor from 1901-1916, wrote that the fireplace should "sound the keynote of comfort and hospitality." The Craftsman movement had social as well as architectural standards to maintain.

The windows of the Brown Shingle house are typically casement or double-hung with pronounced wood frames. The upper segment may be cut into six, eight or even twenty-four smaller panes by wood partitions. The Hillside Club preferred hinged windows which swing outward for an unobstructed view, and French doors, the logical extension. However, Gustav Stickley's recommendation of 1912 is a more fitting description for most Brown Shingle houses in Oakland: "Wherever possible, the windows should be grouped in two's or three's, thus emphasizing a necessary and attractive feature of the construction, avoiding useless cutting up of wall spaces, linking the interior more closely with the surrounding garden, and providing pleasant views and vistas beyond."

The only curtains deemed suitable for the Craftsman window were denim, burlap or cotton crepe, natural fabrics in an age which predated synthetics. Even now, polyester just wouldn't look right with the wood grain which abounds on the interior. Boxed beams criss-cross the ceiling, wainscoting covers the walls, oak constitutes the floor boards, and redwood molding surrounds the doors. The built-in china cabinet with leaded-glass doors, the built-in closet "for wraps" under the stairway, built-in bookcases, and built-in desk are handcrafted of redwood, or more commonly, fir. If there are built-in columns to boot, they will most likely have a plain Doric capital.

Consistent with the use of natural materials, the form of the Brown Shingle house is "organic." That is, it appears to have grown of its own accord, rather than adhering to a formal floor plan. In one typical arrangement, two gables intersect at right angles to form a cross whose longer arm runs the

length of the rectangular lot. From the cruciform, rooms project on an as-needed basis. An upstairs porch to capture a view, for example, or a five-sided bay for a breakfast nook, or an entire wing for the master bedroom.

To accommodate the size and asymmetry, Brown Shingle houses in Oakland are found on relatively large parcels. The yards are filled with big evergreens (deodor cedar, lawson cypress, redwood, even sequoia), trees which are in scale with the building and consistent with a philosophy revering nature. Many of these houses have been reorganized inside as apartment units or business offices, with the fortunate outcome that more people have the opportunity to enjoy the craftsmanship and quiet quality the Brown Shingle Style offers.

Craftsman Bungalow (1905-1925)

Having just discussed the meaning of “Craftsman,” the word “Bungalow” remains to be defined. The bungalow is typically a single-story house with one or more broadly pitched, overhanging gables. On most, a small gable caps the entry porch, echoed by a larger gable behind and to one side. The roofline recalls a child’s drawing of mountains: a series of overlapping, inverted triangles. In Oakland, the other bungalow style shows the broadside of the roof to the street instead of the gable peak. In these, the space beneath the roof is adapted for use by the installation of a dormer window.

To describe houses which do their best to look like bungalows, the awkward word “bungaloid” was coined. While this word is typically used to categorize larger homes designed by architects for wealthy clients, it also applies to a vernacular building style that may be unique to Oakland. Many families find that the bungalow is too limited in size, that the two or three bedrooms do not provide enough living space. Because the lots are small, the only direction that remains is up. The more spacious, but rather ungainly two story result is rightly called bungaloid. Examples can be found on Carington Street in the Fruitvale District.

The etymology of the word “bungalow” is a curious one, and we must travel to the country of India to discover it. In the early 1800’s, the Indian Gov-

CRAFTSMAN BUNGALOW

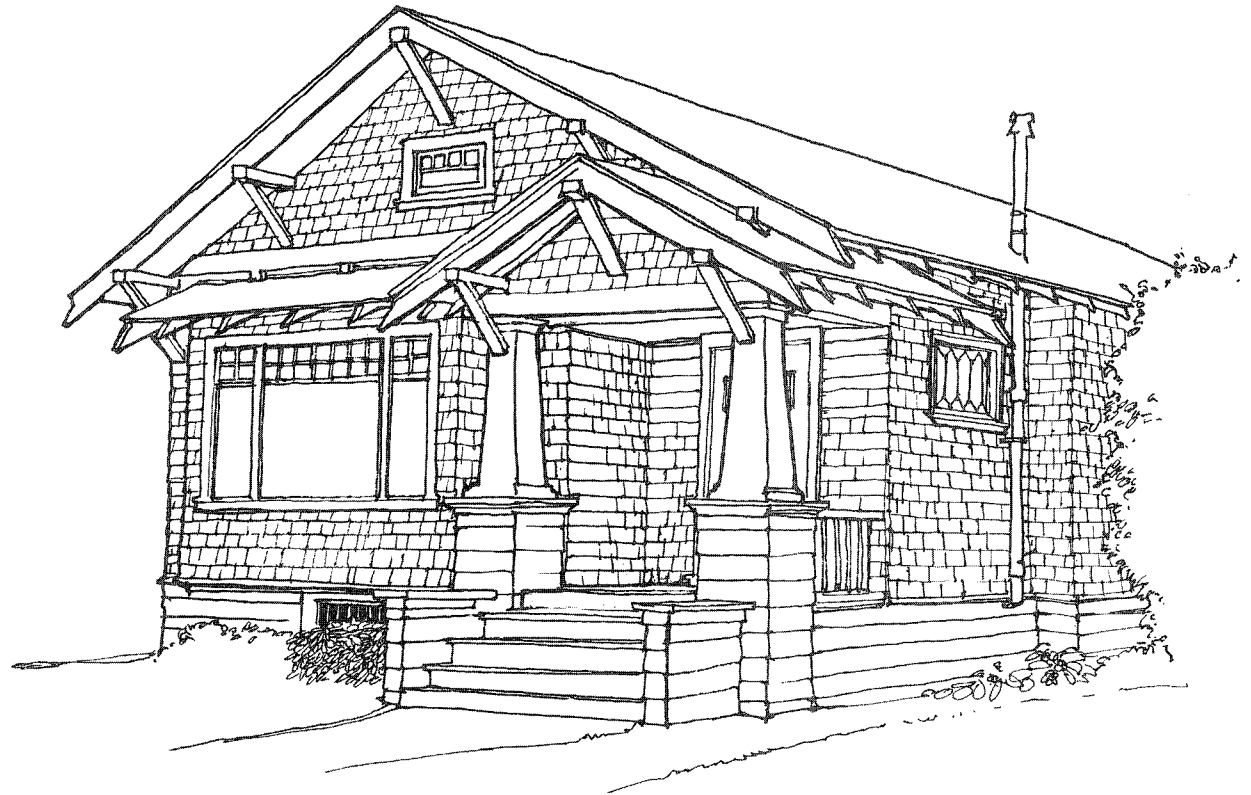

ernment built resthouses along the main road to aid travelers enroute. These thatch-roofed shelters were temporary dwellings, low in profile and surrounded by verandas. The British administrators anglicized the Hindustani adjective *banglā*, which means “belong to Bengal,” and called these way stations “bungalows.”

The Craftsman Bungalow is recognized by the deliberate use of natural materials, its emphasis on structural form, and a casual relationship with the out-of-doors—traits reminiscent of its Indian namesake. The Craftsman Bungalow has exposed beams beneath overhanging eaves, projecting brackets, and a propensity toward Swiss or Japanese motifs. Brown shingles persist, though sometimes woodsiding is used instead.

Two large pillars, broad at the base, slightly tapered at the top, and somewhat foreshortened, support the front porch gable. Made of wood or stone, the columns rest on pedestals which rise up out of the foundation and serve as endposts for the porch railings as well.

Ideally, the foundation of a Craftsman Bungalow would be constructed of local stone so the house would seem to emerge from the earth. In the Oakland flatlands, where building stone is not indigenous, most bungalows have a raised cement foundation sheathed with sculptured cement, brick, or quarried stone for a more textured appearance.

The front window on a Craftsman Bungalow is as individual as a signature. Like a name, the window

is divided into three parts, but beyond that, no two look exactly alike. One house has a trio of double-hung windows with sixteen small square panes on top. Another house has fixed windows filled with leaded diamond shapes. A third has a dramatic stained glass inset, another has mullions in an irregular geometric pattern, and so forth. The design can prove a helpful clue to a precise construction date.

The central window is always the largest of the three panels. Often for consistency, the front door arrangement is handled in the same way as the front window. Two sidelights, narrow panels of glass (leaded, paned, stained or otherwise), flank either side of the entry. The windows on the Craftsman Bungalow are decisively outlined with wood molding and grouped in horizontal bands to complement the dwelling's broad stature. Even the dormer window, with its broad overhang, is designed in careful proportion to the rest of the house.

The interior finish of the Craftsman Bungalow is a showcase of wood. The wall, floors, beams, built-in cabinets and benches are a wealth of grain. The owner had a choice of clear stain, to keep the redwood a light russet; medium, to enrich the surface to cherry; or dark, to deepen the grain to sombre walnut. Above the plate-rail, a wood mantle which caps the dining room wainscoting, there is a strip of wall about a yard high. This is commonly used as a neutral backdrop for decorative plates, bottles, and bric-a-brac propped up around the ledge. The *Craftsman Magazine* recommended a more creative idea. They suggested abstract floral designs which could be hand-stencilled like a frieze around the perimeter.

If informality is a corollary to naturalness, then the floor plan of the bungalow is another expression of the Craftsman ethic. The formal entry hall of earlier styles is discarded completely in favor of the front porch. The front door opens directly into the living room, which itself spills directly into the dining room. The space is so free-flowing, that the dining room is used more for "living" than "dining" and the bedrooms are within earshot of the living areas. Privacy can be hard to come by.

The old-fashioned, subdivided kitchen of Victorian

times is here incorporated into a single room. The pantry, the work counters, the cooking surface, the sink, are reorganized into a "work triangle" for the modern housewife. Gustav Stickley wrote in a 1912 issue of the *Craftsman Magazine*, "The most sensible plan is to have the kitchen large enough to allow some of the meals to be taken there. For there is no reason why this part of the house should not be cheerful and attractive as any other, and certainly where the mother has to do all her own work both she and the family would get more real comfort by simplifying the serving of meals as much as possible."

This new attitude toward comfort and convenience meant much more than the demise of the formal dining room. It marked the introduction of the Twentieth Century California way of life. At last, the Golden State had a residential style all its own, an architecture suited to its landscape, derived from native materials, and adapted to West Coast culture.

Seventy years ago, Craftsman represented a lifestyle as well as an architectural style. Today, the wares of that lifestyle are easy to come by at the many popular crafts fairs in the Bay Area. The pottery mugs, hand-woven rugs, and hanging candles hawked by street vendors fit in perfectly, as do the efforts of indoor gardeners. A Craftsman Bungalow on Hudson Street in Rockridge is a great example. The small size of the lot precludes extensive landscaping otherwise suitable for the Craftsman house. Instead, the owner has designed a magic forest of potted plants which cascade down the steps, fill in the porch, hang from the rafters, obscure the foundation, and generally sequester the house as if it were nestled in a wooded hillside.

Prairie School (1910-1925)

It's confusing, isn't it, that a style with a Midwestern accent is mixed up in this discussion of the Bay Area's own regional architecture. While Frank Lloyd Wright, the renowned Chicago architect, is credited with invention of the Prairie style, his product was brought to California by those who worked directly under him, and those who emulated descriptions of his buildings in the architectural jour-

nals. The expression "Prairie School" refers to the followers, the imitators, and the reinterpreters of the design concept initiated by Wright.

Although the Prairie School style was created to meld with the Midwest Landscape, its attributes are remarkably consistent with the features of the Craftsman tradition in Northern California. Both emphasize natural materials, horizontal proportions, and a kinship with the earth. Wright's design philosophy that "form follows function" blended with the attitudes, material and landscape of the East Bay as easily as it did with Illinois prairie land.

The Prairie School house in Oakland is noticeable right off because of its size. Two or two-and-a-half stories high, it is taller than neighboring bungalows or cottages. Room wings project to either side, making it wider than the typical Oakland house, too. The long, low walls are plastered in pastel colors, earning for it the nickname, Stucco Villa.

The Prairie School house is a juxtaposition of broad boxes which allow the building to adapt to differing site conditions. If the lot is flat, the boxes are at equal elevation; if the lot is steep—and many are in the Grand Lake District where the Prairie School style is found—then the boxes step up the hill. Likewise, the roof plane is broken and steps up the hill. The side expansion of room wings is seen more often on corner property whose size and frontage is more conducive to the expanded arrangement.

Each box is capped by a very low-pitched tar and gravel roof. The eaves overhang to the point of real or suggested cantilever. The shadows cast by the overhangs modulate the stark stucco walls. On some, the rafters are exposed beneath the eaves in a Craftsmanlike manner. On others, a perfectly horizontal board, whose broad side is parallel to the facade, describes the perimeter of the flat roof and enunciates the eave. This is called the fascia.

When one of the wings is a porch, or on rare occasions a portecochere (a covered driveway at the front door), then the flat roof is supported by heavy piers. Remember these. Their influence is felt in the California Bungalow as well as in other features of the Prairie house itself. The weight and proportion of the porch piers are reiterated in the massive, terraced stoop which flanks the front stair progression

PRAIRIE SCHOOL



from sidewalk to front door. The posts' chunky quality is also seen in the heavysset chimney.

Horizontality is also a design element of the casement windows. They are grouped in bands, with shared projecting sills, and appear to wrap around the building. In some examples, there are geometric mullions but more often the pane of glass is left entire, a plain rectangular surface just like the building's walls. In fact, the Prairie School house is a careful composition of planes and voids, like a Mondrian painting.

On the inside, the bands of glass flood the rooms with natural light. While this is desirable, even Craftsmanlike, in concept, it can pose a disadvantage with western exposures. The Prairie School house in Illinois did not have to contend with the strong, late afternoon sun of California. Also, in a dense urban situation like Oakland, the picture windows can make privacy a problem, a dilemma not encountered in the more sprawling development of the Chicago suburbs. Therefore, it is typical to see from the street the soft folds of opaque drapes drawn behind the windows of the Stucco Villa.

Life in a Prairie School house can be sumptuous. The broad proportions evident on the exterior make for spacious rooms on the interior. Even the staircase is wide and the landings ample to match the opulent, airy spaces. The scale of a Prairie house lends itself to the display of large oil paintings, hand-woven wall hangings, and other oversized pieces of art which demand a gracious wall and enough room to step back and view them from a distance.

The cool pastel exterior of the Stucco Villa belies the warm interior where earth tones predominate and the extensive woodwork is stained a golden oak. The hardwood floor, the hallway panelling, and the bookshelves made of gumwood, are all subtly ornamented by strips of darker, mahogany-colored wood inlaid in geometric patterns. The fireplace is built of rough fieldstone and placed at a focal point in the living area. Light colors and fine craftsmanship are the attributes which typify the Prairie School house and sustain its image of elegant simplicity.

In 1916, California architect Irving Gill summarized the new architecture of the West in an article entitled "The Home of the Future." The rhetoric is inflated, but the description a valid one of the Prairie School house in the Craftsman Tradition: "If we omit everything useless from the structural point of view, we will come to see the great beauty of straight lines, to see the charm that lies in perspective, the force in light and shade, the power in balanced masses, the fascination of color that plays upon a smooth wall left free to report the passing of a cloud or nearness of a flower, the furious rush of storms and burning stillness of summer suns. We would also see the glaring defects of our own work if left in this bold, un-ornamented fashion, and therefore, could swiftly correct it."

CALIFORNIA BUNGALOW

California Bungalow (1910-1925)

The last style in this discussion of the First Bay Tradition has a little bit of everything that came before. The California Bungalow shares small size and low-pitched roof with the Craftsman Bungalow, stucco and horizontality with the Prairie School house, and front porch and exposed rafters with the Brown Shingle. The California Bungalow in Oakland is the builders' distillation of the more sophisticated features of its architect designed predecessors. Although extremely plain, especially compared to the bungalows designed by Greene and Greene in Pasadena, the California Bungalow offered comfortable living at popular prices.

In 1920, 216,261 people lived in Oakland, more



than three times the number residing here in 1900. Obviously, there was a need for a house style that could be quickly constructed at reasonable cost and yet perpetuate the California image that had enticed the newcomers in the first place. The California Bungalow filled the bill.

Almost fifty years had passed since the introduction of straightforward woodframe construction in Victorian times. Time and experience perfected the stud-and-joist technique, and simplified it even further. The studs, for example, were placed in a standard 16 inch pattern, in contrast to the Victorian merchant builders who placed studs more arbitrarily and at wider intervals. In wood frame construction the stud extends from foundation sill to roof. The shorter distance from floor to ceiling in the bungalow, combined with the reduced spacing between the studs, resulted in shorter, lighter lumber which was easier to handle. Next, diagonal sheathing was abandoned as the means of cross-bracing. Instead, rigidity was achieved by placing 16 inch long 2 x 4's horizontally between the studs.

Concrete greatly simplified the foundation. Although Portland Cement had been discovered in 1824, its versatility was not fully realized until the twentieth century. It took experimentation with the new product by Wright and other respected architects to bring concrete into the builder's arsenal. Formerly, the foundation consisted of bricks or stones, placed and mortared individually. With concrete, a trench is dug to define the building's perimeter, board forms lined up, reinforcing bars inserted, and the concrete poured in one fell swoop.

Similarly, the siding operation was greatly simplified by the introduction of stucco. Made of Portland Cement, sand, and a small percentage of lime, stucco is applied in a plastic state (hence the word "plaster") over a wire mesh curtain that is wrapped around the building. How much easier this was than using a level to keep each strip of clapboard horizontal, or nailing several thousand shingles on, one at a time.

If anything persisted from the Victorian Era it was the availability of plan books. Printed first in Southern California and later in Seattle, Chicago, and Minneapolis, these publications offered the pro-

spective homebuilder an incredible assortment of bungalow designs. Working blueprints could be ordered for \$5 to \$25, usually less than one percent of the estimated construction cost, which started at under a thousand dollars for a four-room bungalow, and ranged upwards to \$7000 for larger, very elaborate models.

The plan books provided more than design details, however; they also influenced taste and values. The introduction to the promotional brochure "Little Bungalows," distributed by the Los Angeles firm E.W. Stillwell and Company, presents a convincing argument in favor of the "genuine California Bungalow" whose plans they had for sale. "It is better to build a small house than to overburden the budget with debt for a larger one. A beautiful small house is just as expressive of character, aims, and aspirations as the large house. Mere size is a waste of money and human endeavor."

As new materials, construction techniques and mass-produced blueprints simplified house building, so the floor plan of the California Bungalow simplified housekeeping. One room merged with the next, and this meant fewer steps for the foot-worn homemaker. There were no hallways to collect household tumbleweed, no formal parlors to keep "company-clean," no knick-knacks to accumulate dust. The plan books boasted the efficiency their drawings offered. "The economic use of space" was a positive way to say "small," and "cozy" an optimistic word for "crowded." Besides, built-in conveniences more than made up for the lack of room because "movable furnishings," the brochure argued, "so complicate the labor of the cleaning day."

According to the 1925 *Oakland Tribune Yearbook*, 12,312 one-story houses were built in Oakland between 1907 and 1920. Between 1921 and 1924, in one-fourth the time, an astounding 12,822 more sprung up. Most of these were California Bungalows, concentrated in the new East Oakland subdivisions. The rest were scattered on hitherto undeveloped lots throughout the City, making it the most widely distributed house style in town.

The feature unique to the California Bungalow is the pair of elephantine columns which support the

small gable over the front porch. On their own, these heavy-looking posts with broad base and tapered top seem too short and awkward, but in place they are clearly in proportion to the overall bungalow design. Covered in stucco, the columns have a wood framework underneath which is subject to termite damage and dry-rot both. Replacing the columns with anything less substantial in appearance than the elephantine originals—like wrought iron posts, or 4 x 4's—looks skimpy and regretfully out of place.

The origin of the bizarre bungalow columns is a matter of speculation. They were obviously influenced by the hefty piers on the Prairie School house, a style sometimes considered the California Bungalow's larger counterpart, and by the arroyo stone columns on the Greene and Greene bungalows in Southern California. Or, they may be descended from an ingenious Craftsman detail used by architect A.C. Schweinfurt. In 1897, he designed the First Unitarian Church in Berkeley for a congregation whose membership included Bernard Maybeck, Charles Keeler (author of *The Simple Home*, a Craftsman manifesto) and representatives of the sylvan Hillside Club. Schweinfurt used massive redwood tree trunks, peeling bark and all, for the front porch columns on the church. Short, slightly tapered, and mammoth in dimension, the tree trunks may well have been the unwitting precedent for the oversized porch columns which became the bungalow trademark.

The interior of the California Bungalow resembles that of the Craftsman Bungalow, but it is generally plainer. The ornamental use of wood is limited to the moldings, baseboards, and hardwood floors. Sliding or french doors between living room and dining area may persist, but the leaded glass has been eliminated.

The California Bungalow in Oakland stands on a small lot (typically 40' x 100') with an abbreviated front yard and narrow side yard. This lack of land may frustrate the enthusiastic gardener, but the unified appearance is terrific. Look down a block of closely spaced bungalows and you will appreciate the up-and-down rhythm of the roofline, the in-and-out rhythm of the projecting porch. There is an

order to the parade of pastel bungalows that critics call monotonous, but in fact a closer look reveals interesting variations within each house. There is enough repetition to establish a unified framework, yet enough variety for individual identification. This is the essence of good neighborhood design.

Unlike many Victorian neighborhoods whose visual unity has been destroyed by ad hoc demolition or thoughtless remodelling, Oakland's bungalow blocks are still intact. The pleasant, human scale of these neighborhoods, combined with the convenient size and reasonable price of the bungalows, has begun to attract to Oakland young couples and single people in the market for their first home.

Period Revival

The 1920's in California were a prosperity decade not unlike the exuberant period which had launched the Victorian Era seventy years before. This time oil played the role of gold. Three enormous oil strikes in the Los Angeles Basin in the early twenties surpassed all previous development in oil production nationwide. Until this time, gasoline had been a troublesome by-product, useless and dangerous to dispose of. But the Los Angeles strikes were coincident with the arrival of the automobile age, and the refineries were immediately redesigned to extract as much petrol as possible from every barrel of oil. Quite literally, oil stoked the fire of California's headlong expansion. Valued at 2½ billion dollars, the crude oil produced in California in the twenties alone was worth more than all the gold ever mined in the Golden State.

By 1925 in Alameda County, more than 100,000 automobiles were registered, and the popularization of the car precipitated three major changes in the Oakland land use pattern. First, the hill areas, once restricted from development because the trolley cars could not negotiate the steep slopes, were now available for residential buildings. Second, the moguls of the auto industry— General Motors, Fisher Body and Durant—located their factories in Oakland, spurring employment, population growth, and housing starts. Third, it was high time for a reconsideration of the local street network.

In 1927, the Major Highway and Traffic Committee of One Hundred was organized to devise "a comprehensive plan for the reconstruction of the ill-arranged collection of streets of Oakland into a well-ordered system of traffic arteries." They commissioned the notable firm Harland Bartholomew and Associates of St. Louis to conduct the study and prepare recommendations. One illustration in the text shows that although practically all the flat land was already urbanized (that is, served by sewer and water), there were only a limited number of streets with permanent pavement outside of the central business district. Other than Broadway, Telegraph Avenue, E. 14th Street, and a half-dozen more, the thoroughfares were worn macadam "in such condition that the traffic avoids them whenever possible." The report then enumerated major street improvement projects which were the key to fulfilling Oakland's "prospects and promises for the future."

Progress was the parameter, and the twenties were downtown Oakland's finest hour. The commercial buildings which now form the backbone of the central business district were erected in a single decade. Included in the roster are Capwell's, the Hotel Leamington, the Tribune Tower, the Fox Theater, the Central Bank and the dear-departed Athens Club.

At the tail end of the downtown building boom in 1931, an enclave of Art-Deco commercial structures appeared in the vicinity of 20th and Broadway. A facade of terra-cotta, turquoise tile, and incised angular patterns typify this style which is also known as Zig-Zag Moderne. The Breuner's Building, the Gray Shop, the Oakland Floral Depot, the Singer Shop, I. Magnin, and the Paramount are fine examples, known throughout the Bay Area not only for their individual merit as fine architecture, but also for their proximity, creating a theme for the commercial area.

Meanwhile, back in Los Angeles, the young cinema industry had begun to infiltrate the mass culture with the glitter of its own prospects and promises. Gilded movie palaces, bearing the names of major production companies like Fox, Paramount and RKO, brought Hollywood to the rest of the State, where the silver screen convinced the public that

fantasy is reality. This attitude, combined with the flamboyant spirit which accompanied the oil strikes, the automobile age, and a period of prosperity, produced an outrageous architecture. The Californians chose a building style better suited to a film set than the local landscape.

In the twenties and early thirties, theaters, shopping centers and middle-class houses alike were designed to conjure up romantic times and far away places, another "period" in history. The frankness of the Bay Region style had given way to the pretense of Period Revival. No longer did the houses appear to emerge naturally from native soil; instead they looked as if they had been plucked from the thirteenth century English countryside and deposited in twentieth century urban America.

The longing for a foreign atmosphere was so great that entire tracts would be developed in a Provincial or Mediterranean mode as if it were a miniature European settlement. In Oakland, there was one called "Court of All Nations" and another, "Normandy Village," which is still intact on Holly Street, east of 73rd Avenue. Local builder Walter W. Dixon went one step better than just developing the eclectic houses. He published a magazine from Oakland called *Home Designer* to nurture an appreciation of Norman arches, Tudor half-timbering and Spanish pergolas, and to promote his product.

Another valuable, and somewhat less biased, guide to housing fashion in the twenties is the professional journal *Western Architect and Engineer*. Their report of the California Complete Homes Exposition conducted in Oakland in 1922, for example, shows Spanish residences with "cheerful" interiors, and two-story stucco houses with window shutters and arched doorways, designed by the architectural firms Miller and Warnecke, and Reed and Corlett. Equally informative are the advertisements, which confirm the popularity of oak floors, wallbeds and pastel paint, and provide the historical sleuth with meaningful clues to a building's original materials. Both periodicals are available at the Fine Arts Desk of Oakland Public Library, itself designed by Warnecke in 1949.

As with earlier house styles, there is a large and

small version of the Period Revival prototype in Oakland. The larger examples resemble the Stucco Villa and the smaller ones the Bungalow, primarily because they had to respond to the same size subdivided lots and utilize the same available building materials. No matter what the size or sub-category, all Period Revival houses have one outstanding feature in common: incredibly tidy owners. The lawns of Provincial cottages in Oakland are always mowed to crewcut precision, the prominent picture windows always streakless clean, and the welcome mat placed perfectly parallel to the front door.

Mediterranean Style (1915-1935)

The Mediterranean Style house is easily identified by red roof tile. This is not to say that it has a red tile roof. Rather, the bulk of most smaller houses is covered by a flat or low-pitched tar and gravel roof concealed behind a parapet or the front porch gable. Typically, it is only the porch, or parapet, which is covered in red tile, but the suggestion is enough to set the Mediterranean mood for the entire house.

Originally, when the semi-cylindrical tiles were handmade by peasants in the Spanish countryside, wet clay from the native soil was shaped over the workman's strong thigh. Today, the tiles are made in molds and held together with wire, but the installation process is basically the same and the textural effect almost identical. The tiles are placed in interlocking rows, alternately facing up and down. The water that runs off the rounded back of the top tiles is collected in the swale created by the u-shaped bottom tiles. There is a pleasing unevenness to the rows of overlapping pottery that even machine modules cannot regulate.

The Mediterranean Style house is invariably sheathed in stark white stucco, a dramatic counterpoint to the undulating tiles. There is little color on the house, save the terra cotta of the tile and the wood frames of the six-part casement windows which are painted burnt sienna, or occasionally, as on Vernon Street in Adams Point, turquoise blue. The earthy red, clean white and bright aqua are a lively and attractive palette.

The ornamentation on the Mediterranean Style

MEDITERRANEAN STYLE

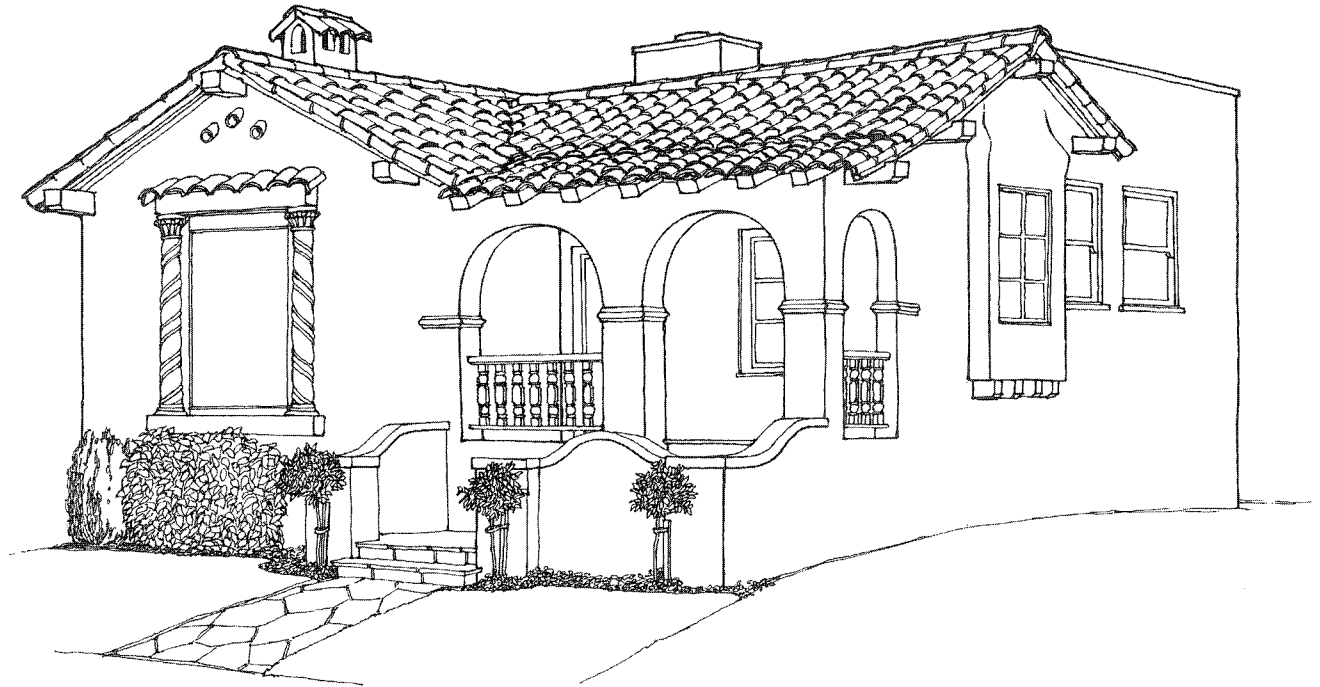

house is restrained compared to the explosive Victorian Styles, but a bit pompous compared to the ascetic Prairie School. Wood or wrought iron is used for second-story balcony railings on larger homes, or as window grills on cottages. On some houses, distinctive twisted columns support the front porch roof in post and lintel fashion, or frame

the living room picture window. These twisted posts and similar baroque features characterize the "Churrigueresque" style (pronounced chi-ree-garesk), named after the Barcelona architect who first designed them in the 17th century, Jose de Churriguera. His decorative style, which dominated Spanish and Mexican architecture in his own time,

was revived at the San Diego Panama Pacific Exposition in 1915 and incorporated in the vogue for Mediterranean architecture which followed.

The Hearst Castle at San Simeon has the most exaggerated examples of Churrigueresque towers and spires. Its architect, Oakland native Julia Morgan, was mentioned as a practitioner of the Craftsman Tradition, but she was so prolific, with over 1000 commissions to her credit, that she was proficient in the Mediterranean Style as well. The Berkeley City Club she designed on Durant Avenue has a Hearst Castle flavor, but her residential work in Oakland and Piedmont show the flair and expression possible in the Mediterranean Style at a smaller scale.

We use the inclusive name "Mediterranean" for this style because the architectural elements are assembled from the lands which border the Mediterranean Sea—Spain, Italy, and the Islamic world of North Africa. The coastal climate of California is classified as Mediterranean, one of only five such areas found in the world. (The other three are the coast of Chile, southwest Australia, and southwest Africa.) Because climate determines the plants and animals that survive in a given environment, the natural setting of California is very much like that of the countries on the Mediterranean shore. As a result, the house style that derives from Spain, Italy and Northern Africa can look extremely convincing in California because it fits right in with the landscape.

If there's red roof tile, you can be sure there are arches on the house too. Either the porch, the front window, the front door, or all three, have an arched opening. The arch may be pointed, rounded, flattened, or a circle with a peak in the Islamic manner. Even the weep holes which stick out through the facade to allow the tar and gravel roof to drain, or the attic to air, are arranged in an inverted curve. Extending from the side of many Mediterranean Style houses is a stucco wing wall with another arched opening. This provides a gracious entrance to the backyard, when the arch is the size of a door, or a ceremonial entrance to the garage, when the arch is as wide as the driveway.

The front walk and the driveway are an abstract

composition of paving stones cut at acute angles and installed in a random manner. To match the roof and trim, they are usually painted a brownish red, a startling contrast to the patch of kelly green grass to either side. Originally, it was fashionable to paint the different stones assorted hues, and East Oakland homeowners who enjoy striking color combinations have perpetuated the trend.

Inside the Mediterranean Style house the walls are covered with a rough, almost lumpy plaster that is either white, or an integral earth tone to simulate adobe. Dark wood beams are exposed across the ceiling. The Churrigueresque motif is picked up in staircase bannisters, and the arch—in whatever form it took outside—is used for a passageway between rooms. The fireplace is sheathed in white, integrated into the wall adobe-style, and surrounded by ceramic tiles. To either side there is an arched recess for display of candlesticks, keepsakes, or religious icons.

Large Mediterranean Style houses are found in Lakeshore Highlands, Oakmore, Trestle Glen and scattered in Piedmont Pines. In Rockridge, above Broadway, architect/builder Fred L. Confer was responsible for some of the most handsome examples. In North Oakland, San Antonio, and East Oakland, smaller Mediterranean houses are more common, filling the space left between California Bungalows, Neoclassic Boxes and Queen Anne Cottages.

There are three tracts composed entirely of Mediterranean homes which are so well integrated with one another that a visit there is a cross between a trip to Spain and a tour of Universal Studios. One is found on the loop road comprised by Castello and Cordova Streets, just off Fruitvale Avenue. A second is located on 77th and 78th Avenues between Holly and E. 14th Streets. The third, largest and most varied fills a six-block area around the intersection of Monterey Boulevard and 35th Avenue. The residents of these three "villages" take exemplary care of their homes and maintain a quality neighborhood image. They make it clear that this is a good place to live.

Provincial Style (1919-1935)

When William the Conqueror invaded England in the year 1066, he brought from France the Norman style of architecture. With that, peaked roofs and gothic arches proliferated and became the trademark of the vernacular country home. Nine hundred years later, when the doughboys returned to the United States from the continental battles of World War I, they brought home a taste for the quaint cottages and picturesque settlements they had seen abroad. Yet somehow, when the medieval imagery was transposed to California soil, the result resembled a dollhouse.

Provincial style houses in Oakland are small in scale and fussy in texture. They can be identified by a gambrel or steeply pitched roof that is covered with slate or a composition shingle which was especially designed to look like thatching. Gladding, McBean and Company, the largest West Coast tile manufacturers of the period, advertised that the coloring of its roofing product "reproduces the stains of lichens and storms," and, they bragged, "it smacks of storied antiquity."

The walls of the single-story Provincial house are built of rough stucco on a frame of 2 x 4's, but stone, brick and wood are incorporated for decorative effect. The wood is used in the manner of half-timbering, a technique associated with English Tudor style houses of Shakespeare's time. In real half-timbering, the spaces between the hefty structural members are filled with plaster or brickwork; the resulting triangles and rectangles form the facade. In the twentieth century version, however, the exposed wood is only ornamental. The geometric pattern of dark timbers and white spaces is applied over the structure, not as part of it.

Originally, stone was used for foundations and front steps, a convenient way to recycle the boulders strewn across Britain's fields. But when the Norman and Tudor style houses were reinterpreted in the twenties, technological advances made it more convenient to build a concrete foundation, and cover this with a rock veneer. Stone is also used as decorative trim around windows and doors, appealing to the person who believes a man's home is his castle, and should look like one.

A castle is impenetrable, and in that vein the Provincial house has very few openings. The simple board or panelled door has only a small lookout window, if any. The living room has a large, arch-shaped picture window, but this is typically partitioned into very small panes by heavy lead mullions. The casement windows are small, sometimes hooded, and occasionally reduced to narrow slits suited at best to an archer's bow.

As expected, the interior is cool and dark, private and secluded, with limited access to the yard, and little connection to the foreign, urban landscape outside. A floor plan as irregular as possible adds

PROVINCIAL STYLE

to the mystery, as do hidden stairways, passages between rooms and real or suggested changes in the floor level. The roughly plastered rooms are small in size and unconventional in shape—romantic perhaps, but not always comfortable. As we have noticed with every house style since the 1870 Italianate, the fireplace picks up the architectural theme, and in the Provincial house, a large hearth of coarse brick or unmatched stones is indispensable to the image.

While this style was practiced by architects W.R. Yelland, Carr Jones, Walter Ratcliff and Henry Gutterson, a simple builder's variant of the Provincial



house is common in both North and East Oakland. Its plain stucco walls, often painted mustard, ochre or umbre, the single story, and the front porch, are all suggestive of the California Bungalow. Although the expression is quite different, the two styles look well intermixed because the size and scale are the same. The steep roof and Tudor arch picture window are the features which distinguish the imported Provincial style from the regional neighbor.

An outstanding example of Period Revival architecture in Oakland is the Idora Park tract between Telegraph and Shattuck, 56th and 58th Streets. Until 1927, this was the site of the most spectacular amusement park ever built in the East Bay. At the turn-of-the-century, F.M. "Borax" Smith and the Realty Syndicate developed this extravagant attraction to lure potential investors to nearby real estate. Extensively landscaped, Idora Park was an ideal picnic ground. When the beer and sandwiches were consumed, there was so much more to do for "fun, frolic and jollification": the Laughing Gallery, the Scenic Railway, the Great Coal Mine, a Tea Garden, a Merry-Go-Round, a full-fledged theater, a Friday Night Amateur Contest, and countless other entertainments, all for the price of a single dime. According to the 1909 Oakland Chamber of Commerce, Idora Park was as exceptional for its "cleanliness and wholesome atmosphere" as it was for the facilities it offered.

When Idora Park changed from amusement park to housing tract, every trace of the original landscape was razed, the native oaks included. The Period Revival house, after all, was not meant to fit in, but to stand out. Each Provincial Style house in the enclave has a large living room window on the right and a recessed front door atop three or four red front steps on the left. The picture window is treated in a variety of ways: one is surrounded by flat, irregular stone; another is barely shaded by a projecting, shingled hood; a third is partitioned by mullions; and a fourth concealed by a striped metal awning. The steep peaks, cylindrical towers and gambrel roofs calmly alternate with the low pitched tile roofs of their Mediterranean Style neighbors. What a wonderful fantasyland! The unusual glass-globe streetlamps are not even fifteen feet tall and there are no overhead utility lines.

All-American Ranch Style

The make-believe world of Period Revival was jolted back to harsh reality by World War II. In the thirties, housing starts slowed down for lack of funds; in the forties, for lack of materials. No longer could architecture afford pretense. The few dwellings that were constructed had to be erected quickly and efficiently in order to house the workers who migrated to war-related industries, the meccas of employment.

California became a center of manufacturing for the defense effort and received more than a proportionate share of federal spending. During the war years, Washington pumped some 3½ billion dollars into the California economy, fueling employment and consequently boosting housing demand. The airplane industry was centered around Los Angeles, but thanks to Henry J. Kaiser, ship building was concentrated in the Bay Area—Richmond, Oakland, Sausalito, and Vallejo. The shipyards were in operation 24 hours a day, and at peak capacity in 1943 a new freighter was launched every ten hours.

It took three shifts and a work force with no barriers to race or sex to operate these enormous factories. Such numbers had never before been employed in Oakland. To provide them housing, and to anticipate the wave of soldiers who would need a place to live when the war ended, three new subdivisions were developed in Southeast Oakland. A major rezoning effort was necessary between 1942 and 1944 to accomplish this. The 460 acres in the vicinity of the area where the Nimitz Freeway and 98th Avenue now intersect, that had been zoned for industrial use, were switched to residential use instead.

The Wartime Tract house, subsequently built there, is an early species of the All-American Ranch Style, a dwelling type that would totally dominate the national housing market from the late 1940's on. What better way to package democracy for a returning soldier and modern consumer both, than a plot of land, a detached home, and a private parking space for every family. Later examples of the All-American Ranch Style found in Oakland, but not discussed here, are found in the Crestmont,

Sequoyah Hills, and Park Ridge Estates subdivisions.

Once the demand for housing clearly outweighed the supply, it was necessary to impose municipal regulations to protect a public no longer able to pick and choose. Well over 600 subdivisions had been platted in Oakland before 1939, but for the most part, improvements were at the behest of the developer who recognized amenities as an aspect of promotion.

In 1939, the City of Oakland adopted its first set of subdivision regulations, and the three Southeast Oakland tracts were early examples of its implementation. The subdivision ordinance, which has since been expanded, determined the width and turning radii of streets, designated the size of the blocks, and required that the developer provide

paved streets, curbs, sidewalks, storm drains and sanitary sewers. The evolution of the All-American Ranch Style went hand-in-hand with the gradual sophistication of subdivision regulations which governed the development of site plans for what has likely become the most widely distributed architectural style in the United States.

Wartime Tract (1942-1945)

The Wartime Tract house is a small, one-story building on a concrete perimeter foundation with five rooms and a pitched roof. The roof is shingled and the exterior walls are finished with either stucco or rustic siding. In Oakland, the Wartime Tract house is concentrated in Columbian Gardens, Brookfield Village and Sobrante Park. It is also scattered along the avenues among the California Bungalows in the

WARTIME TRACT



80's and 90's, below East 14th Street.

The three subdivisions mentioned were the work of three different contractors—Phillip Heraty, The Brookfield Corporation, and Shultz Construction Company, respectively—so each has modifications of its own. However, the Wartime Tract house is basically rectangular in shape with the broad side facing the street. The roof overhang is supported on two-by-fours to create a recessed front porch. The parking area is usually a detached pad or carport, although in Brookfield Village where the houseplan is u-shaped, the garage is incorporated in the body of the house.

Mysteriously in Sobrante Park, many houses have two front doors. This is attributed to the wartime custom of inviting defense plant workers to board in the family home. The extra door leads to a room which could be closed off from the rest of the house on the inside, securing privacy for the boarder and family members both.

The interior of the Wartime Tract house consists of a living room, a dining room, a kitchen, two bed-

rooms, and a bath. The limited dimensions of the rooms and the constraints the small size imposes on a growing family are the same drawbacks of the California Bungalow. To overcome this, some families have expanded the house to the back with the addition of a family room, an extra bedroom, or just a sliding glass door leading on to a patio. Other property owners have converted the garage to living quarters, and still others have added a second story above the garage.

What little decoration there is on the Wartime Tract house is typically an imitation of some earlier, more established style. Window shutters are meant to suggest colonial architecture, the diagonal brackets on the porch posts are a souvenir of Victorian times. The porch railing may have some craftsman-like stickwork, or the living room window may be subdivided by wooden strips in imitation of Period Revival leaded glass. On many examples, a veneer of brick is mortared over the lower portion of the facade to simulate a masonry foundation and lend an air of permanence. Ironically, in the chimney where the brick is truly structural and not decora-

tive, it is camouflaged with paint, the same pastel color as the rest of the house.

The Wartime Tract house is sited further back on the lot than the typical Oakland bungalow or row-house. This gives the impression of more land as befits the All-American Style. However, the lots are only 75 feet deep to begin with, so the effect of more land in front is achieved by sacrificing precious backyard space, a hard bargain. The sidewalk is next to the curb, with no planting strip in-between, and this too makes the lawn seem more spacious than it really is.

Thanks to the site planning, Sobrante Park has one of the most successful examples of street tree planting in the City. There is a London plane tree, or two, in the front yard of every house, instead of in the planting strip as elsewhere in Oakland. The location of the tree on the house side of the sidewalk gives the roots ample space for nourishment which promotes vigorous growth while precluding the risk of sidewalk damage. The canopy of leaves is especially graceful because the trees are mature and the streets are curved. 

Chapter 3.

BEFORE YOU BEGIN

Before you begin to rehabilitate your house, there are practical decisions to make and preparatory steps to take. Certain financial, professional, legal and safety questions must be answered before the hammer comes out of the tool chest.

HOW MUCH MONEY SHOULD YOU SPEND ON REHAB?

Establish Your Goals, Understand Your Motives.

Rehabilitating as an investment for purposes of immediate resale is quite different from rehabbing to fill a housing need or to improve your living quarters. If you plan to live in the house for many years (say over five), the resale value of improvements is less important because the costs can be amortized over several years, and the changes are enjoyed for that much longer. A personalized design for your own living environment will undoubtedly cost more than a neutral design suitable for quick resale. REHAB RIGHT advocates that you do not impose your personality on the house, but let it express its own character. This is often more economical too, since you are spared the expense of unwarranted "modernization."

To recapture costs in the near future, do as little decorative work as possible. Stick to the fundamentals, and let the new owners decorate to their taste. Improvement for immediate resale need not be disreputable if the decisions as to where to

spend the money result in basic improvements rather than cosmetic changes.

If a Letter of Compliance cites code violations in the house, your goal may be limited to getting a Certificate of Occupancy. When bringing a building up to the applicable code, try to understand exactly what needs to be done, and do your best to accomplish this goal without destroying the very architecture you set out to preserve.

Whatever your goal. . .

Do the Basics First

Spend your rehab budget on the essentials before going on to frills. In order of priority:

1. **Life and Safety Hazards:** electric and heating systems should be up to code. A fire can cause injury or death, and destroy all of your investment.
2. **Weatherproofing:** roof, gutters, flashing, sheathing, paint, windows, and drainage should be in good condition. Water leakage will engender costly repairs and can ruin rehab efforts.
3. **Plumbing:** pipes and fixtures must be in good enough condition to preclude water damage. Never conceal faulty pipes behind new or improved walls.
4. **Dry rot and foundation problems.** Structural damage must be corrected before ornamentation is restored.

After these fundamental repairs have been accomplished, funds remaining in the rehab budget can be used to improve the comfort and resale value of the home by restoring exceptional architectural features, redesigning the kitchen or bath for modern convenience, and the like.

Don't Spend More Than You Can Afford

Establish a rehab budget before you do anything else. Here's how: **First, determine how much money you can afford to spend on housing each month.** Conventional wisdom has it that housing

should cost between 25% and 30% of net income. If your monthly take-home pay is \$1000, then the housing budget should be \$250-\$300. (To multiply by a percentage, remember that "Per Cent Means Hundredths." Drop the per cent sign and put the decimal point two places to the left. In the example, 30% becomes .30, so $\$1000 \times .30 = \300 .)

To personalize the 30% rule-of-thumb, review your records to see how much housing actually costs you. If you've been spending \$300 a month out of \$1000 take-home pay, and still have been able to put \$50 per month in the savings account on a regular basis, then you can probably afford a higher housing budget if you are willing to dedicate future savings to the rehab job. The reverse also holds. If \$300 per month has been too steep, don't plan to spend that much in the future either. If you forecast an increased income, make sure the prediction is reliable enough to bank on before enlarging the housing budget.

Second, find the difference between the amount of money you can afford to spend on housing (just derived) and the bills you currently pay. The difference will be available for rehab work. Continuing the same example:

<i>Housing Expenses</i>	<i>Cost/Month</i>
Mortgage Payments (principal and interest)	\$110*
Real Estate Taxes	65
Insurance (fire and liability)	25
Utilities (PG & E, water, garbage)	40
Miscellaneous repairs & reserves (10% of total)	24
TOTAL	\$264/month

*Assumes a house bought 10 years ago for \$24,000 with a 5½%, 25 year, \$18,000 mortgage.

The difference between the \$300 affordable and the \$264 expended is \$36 a month. What will \$36 a month buy? That is what determines the rehab budget.

Shop around for the best way to parlay the extra housing money that is at your disposal. Different banks have different loan programs. Interest rates and terms vary markedly from one institution to the next, so do make comparisons. Most banks answer such questions on the telephone. The selection of a loan program depends to a great extent on your financial strength, because this is the criterion by which banks evaluate credit and the City determines eligibility for subsidized loan programs.

Continuing the same example, in fall, 1977, \$36 a month could "buy":

- A \$1362 bank home improvement loan (13% interest, 48 month term).
- A \$1618 bank home equity loan (12% interest, 60 month term).
- A sum of \$3900 after refinancing the house in the example.*
- A \$681 signature loan from a commercial finance company (26% interest, 24 month term).
- A home improvement or home equity loan from your credit union, where your status as a credit union member makes you more eligible for a loan than you might be at a private institution.

* If the house were appraised at \$35,000 today, it would support a new 25 year, 9% loan of \$17,400. The \$17,400 would pay off the 13,500 outstanding on the old mortgage and provide a sum of \$3900 for rehabilitation, minus appraisal fees (about \$100) and points (\$260).

The lender offers a more attractive program to borrowers who take out more money. For a home improvement loan, the lowest interest rate and longest term is available to those who borrow \$3500 or more.

For \$54 a month, you could borrow \$3500 and pay it back over 96 months at 10.25% interest. If the \$3500 is used to remodel the kitchen, fix the

heating, or add a room, then a special program would entitle you to pay \$47 a month for a 120 month term at 10.25% interest.

The threshold for a home equity loan is \$5000. For \$66 a month, you could borrow \$5000 and pay it back over 144 month term at 12% interest. If, for the sake of argument, you were borrowing \$4999, you would be in the under-\$5000 category, and you would pay \$100 month over a 72 month term at 13% interest instead.

The difference between the two monthly payments is attributed to the difference in the length of term. The difference of a percent between the two interest rates is negligible. If, hypothetically you borrowed \$5000 at 12% for a 72 month term, the monthly payment would be \$97.75.

Obviously your banker will be one of the most important, and most knowledgeable, players in the rehab financial process. Consult with him or her early in the game.

What if there is no difference between the amount you can afford and the amount you already spend? What if, after calculating the figures above, you simply have no rehab budget? **You may be eligible for one of the City's subsidized loan programs.** Descriptions of the programs, and telephone numbers to call, are listed in Chapter 6.

If you are about to buy a house that needs work, **try to finance the rehabilitation with the first mortgage.** This is a loan based on the improved value of the house, and allows you to get home improvement funds at the mortgage rate (about 9.25%) instead of the more costly rate for home improvement loans (10.25% - 19%).

Say you are about to buy a house for \$25,000 but it needs an additional \$5000 work for basic rehabilitation. The lender's appraiser should agree that once improved the house would be worth at least \$30,000 invested. If you are arranging an 80% loan for the mortgage, then at the same time you will be financing 80% of the extra \$5000, all at the mortgage rate of 9.25% for 30 years. The mortgage payments would be \$197 a month.

If, instead, you secured a separate home improvement loan for \$4000 (80% of \$5000), then, at best,

you would get 10.25% and a 120 month term for \$53 a month. Meanwhile, you'd be paying \$165 a month on your first mortgage (9.25%, 30 year term, on 80% of the \$25,000 purchase price). Your combined payments would be at best \$218, instead of \$197.

The real estate broker can play an important part in getting the bank to combine the rehab money with the first mortgage. Well before you sign the deposit receipt, tell the broker the amount you must have to rehabilitate the house. The broker, eager to make the sale, may be more persuasive than you are with the loan officer at the bank.

If this is ineffective, the broker can approach the seller for a Second Deed of Trust. Instead of taking a downpayment completely in cash, the seller takes back a second mortgage on the house. The buyer pays this back over a short term, say five years, with interest, say 10%, the maximum rate allowed by state usury laws for individual lenders. At the end of the term there will still be capital outstanding to pay back in a "balloon" or lump sum payment. If the seller is anxious to sell, and the broker handles the negotiations properly, this is another way to finance rehabilitation. The cash that you would have used for the downpayment is available instead for home improvements.

Financial strength is not the only factor to influence how much to spend on rehab. Also be careful to:

Avoid Overimprovement

The value of a house is heavily influenced by the value of surrounding property and the quality of the neighborhood. Some areas are experiencing dramatic increases in property values; others are stable; and yet others are deteriorating. Improvements to one home that are in concert with improvements to other homes nearby can push property values up. In other cases, however, improvements beyond a critical threshold will not add to resale value, or even have a spin-off effect on the rest of the block.

Whether moving into a new house, or fixing up the place you live now, **see if the area is on an up-swing.** Call the appropriate City offices (listed in

Bank of America
Home Improvement Loans
 Fall, 1977

RATES			EXAMPLE		
Amount	Interest	Term	Loan	Monthly Payment	Total Dollars Paid Out Over Term of Loan (Principal and Interest)
up to \$1,000	19%	36 months	\$ 1,000	\$ 36.66	\$ 1,320
\$1,001-\$2,000	16.25%	60 months	\$ 2,000	\$ 48.90	\$ 2,934
\$2,001-\$3,500*	12%	84 months	\$ 3,500	\$ 61.78	\$ 5,190
\$3,500-\$10,000*	10.25%	96 months	\$10,000	\$153.07	\$14,694
*For room additions, kitchens, heating, air conditioning, or swimming pools:					
\$2,001-\$5,000	10.25%	120 months	\$ 5,000	\$ 66.77	\$ 8,012
\$5,000+	10.25%	180 months	\$ 5,000	\$ 54.50	\$ 9,810

Chapter 6) to learn if parks, sidewalks, street trees, loan programs, or any other public projects are slated for the area. Ask about the schedule and the precise boundaries. Check out the neighbors' contribution to environmental quality by driving around the neighborhood. From the street you can judge the interest and energy owners and tenants put into their property. Yard upkeep, fresh paint, general maintenance, and overall cleanliness, are good indicators. Look too for signs of work in progress: debris boxes, trade trucks, scaffolding.

The exact measure of "overimprovement" is difficult to establish in precise terms, and most realtors hedge when asked. To get a feel for how much you can afford to improve the house and still recoup the investment, look at the direction the neighborhood is moving, as described above, and **investigate the market value of houses comparable to your own.** There's enough activity in real estate these days

that there are bound to be two or three houses nearby with "For Sale" signs up. Call the agent and inquire as to the "asking price." This is the amount that the owner would like to get, and that the realtor thinks he or she can reasonably expect. However, it is not necessarily what the buyer actually pays, and that is the true market value. Short of asking the new owner directly, the selling price is not as easy to come by.

One way to ferret it out is to check the real estate transfer records at the County Recorder's Office (Room 100, Alameda County Courthouse, 12th and Oak Streets, 8:30 - 5:00). Special stamps are affixed to deeds at the rate of \$1.10 per \$1000 transferred. If the sale is outright, then this tells you the selling price. However, if the buyer is assuming a loan, the difference between the loan and the sale price determines the amount of tax stamps, and the actual selling price is obscured.

Another technique to determine the overimprovement threshold is to talk to a local realtor about listing your own house. Find an agent who serves your neighborhood, and request a price tag for your house "as is," and with selected improvements. Ask him or her how this figure relates to comparable sales nearby. The members of the Oakland Board of Realtors have access to a computer print-out which lists asking and selling prices of reported real estate transfers in Oakland, and your agent will undoubtedly refer to this source to derive a price for your home.

To make this information useful, **calculate the difference between the approximate market value of your house and the amount of investment you now have in it.** This is the leeway you have if profit or breaking even are your only concern. However, enjoyment of your home is an equally important criterion if you plan to live there for several years.

WHEN SHOULD YOU HIRE A PROFESSIONAL?

And When to Do-it-yourself

A common way to keep the rehab budget in line with the housing budget is to do the work yourself. While this saves money, it may have other costs in time, quality, and general aggravation. One facetious prediction has it that “remodelling your house can bust up your marriage, force you into bankruptcy, or drive you to a nervous breakdown.”

There is a time for professional help in any rehab job. The professionals who could become involved are: *civil engineers* to evaluate structural conditions; *architects* to design structural changes; and, *contractors* to perform the construction work. A general contractor, usually a carpenter by trade, oversees the entire job, coordinating the work of various specialists, while a subcontractor is the specialist himself, like a plumber or electrician. The subcontractor can be hired directly, as well as via the general contractor.

It is wise to **hire a professional when:**

- the job requires technical skills you do not have, or are not readily learned
- the job requires tools and equipment that are unfamiliar to you or infeasible to rent
- you want the job completed in a short or specified period of time
- your time is worth more than your money
- codes completely baffle you, to the detriment of the final product
- the quality of your workmanship is so poor that it may cause additional damage, or signal additional costs of doing it over to a prospective buyer, in other words,
- when you don't know what you're doing.

It is required by law that you **hire a licensed contractor if:**

- the applicable code so states
- the loan contract so stipulates
- you plan to sell the house within one year of completing the improvements.

Despite these precautions, there are many opportunities to participate in the rehab process and save money doing so. Most people will be able to identify certain portions of the rehab project which they can comfortably handle. Once you have consulted Chapters 4 and 5 for the particular repair problems you face, you will probably discover that you can do much more than you had suspected. In fact, **rehab work that is sensitive to existing architectural features is often a lot easier to do than a contractor's solution of modernization.** Many general contractors are amenable to letting the owner play a part, but this must be agreed upon in advance.

Handy men and women experienced in construction may choose to be their own general contractors. This is a very complicated undertaking, requiring full-time attention to detail. It can, however, save 15%-20% of the total construction cost, the equivalent of the general's profit and overhead.

Whether you face a major construction project, or an individual case of disrepair, **identify tasks to do yourself which:**

- require a sensitivity to architectural features, as described in Chapters 2, 4, and 5—these are the very chores the contractor is likely to avoid in pursuing the more expedient route of modernization
- utilize your skills and equipment, or skills you would like to learn and equipment you can conveniently rent or acquire
- are time intensive but require limited skill (like stripping woodwork or scraping out stucco cracks)—here, rehab work can really become a family affair
- will give you a sense of pride and satisfaction in your accomplishment.

With all this in mind, outline which portions of the rehab job, you can realistically handle yourself, and which assignments require professional skills.

Selecting a Contractor

Selection of the right contractor, or architect, is a skill in itself. There are six pages of listings under “Contractors—Alterations” in the “Yellow Pages”

of the Oakland Telephone Directory, and effectively sifting through these is as important as the architecture you set out to save. Here are some guidelines:

1. **Get recommendations** from friends, relatives, neighbors, owners of similar style houses, building suppliers, hardware merchants, subcontractors, and bankers. It's important to get first-hand information about the quality of the contractor's work. How understanding is he, and how easy is he to understand? Be certain that you can talk to the contractor, or your plan to REHAB RIGHT may be stymied. Most contractors will have their own way of doing things, which is often contrary to the architectural sensitivity advocated in this manual. Find out if he is willing to read this book. Maybe he already has.
2. **Reliability is critical.** Be certain the contractor has an established business. The home improvement racket constitutes the largest number of consumer frauds in the United States according to *The Complete Book of Home Remodeling, Improvement and Repair*. Fly-by-night characters abound. A business office, no matter how small, and at least one staff member, are some assurance that your contractor is not just operating out of a glove compartment. Check the Better Business Bureau for registered complaints. Reliability also relates to whether he is on time, abides by his estimates, and is generally honest. Ask the people who recommend him about these traits.
3. **Check for a contractor's license.** Any person contracting for a building job worth \$100 or more must be licensed by the State of California Department of Consumer Affairs. The license is granted only when the applicant has passed required tests, and has had four years of experience. You can verify license status by calling the Contractor's Licensing Board (464-0964), or by asking to see his pocket license. The latter assures you that he is not an imposter. The license, however, does not guarantee that the contractor is perfect, or that he is the right person for your

job. *Caveat emptor*. (Buyer beware).

Unlicensed contractors is a category which lumps together all sort of folks, from the crooked shyster, to the ambitious handyman, to the talented craftsman. While the unlicensed contractor may be performing in violation of the Contractor's License Law, he will probably charge less money and therefore seem more attractive to you. Even if a maverick shows more sensitivity to architecture, be careful. Hiring an unlicensed contractor entails considerable risk on the property owner's part.

- A licensed contractor is responsible for installations that meet code requirements. If the contractor is not licensed, the burden is on the owner. If any construction is found to be in violation of code, then the owner must pay to have the job done over correctly. The second time he usually hires a licensed contractor.
- A licensed contractor is required by law to carry workman's compensation insurance. Construing the unlicensed contractor as your employee, you too must carry workmen's compensation. While most homeowners insurance policies have a workman's compensation clause, it is usually limited to an employee who works no more than 20 hours a week. This can be amended to cover a full-time worker for about \$130 a year in additional premiums. Be certain to check with your insurance agent first.
- A licensed contractor can also carry property damage insurance and public liability insurance, although this is not required by law. He'll pay several thousand dollars a year in premiums for the privilege of this kind of commercial insurance that is not available to the homeowner who is hiring unlicensed workers.
- A licensed contractor carries bonds to guarantee that there is monetary recourse if he walks out on the job before it is completed. An unlicensed contractor is rarely eligible to offer such assurance.
Find out in advance what kind of insurance and bonds the licensed contractor you are in-

terviewing carries and if the amounts are sufficient for your particular job. The state requires a minimum bond of \$2500, but if you have a job worth \$8000, the bonding is inadequate.

4. Evaluate the **contractor's experience** on problems and houses similar to your own. **Pay special attention to his sensitivity to architectural features**, like those described in Chapter 2 for the style of your house. Compare examples of his work to the "Don't" sketches in Chapters 4 and 5, as listed in the Table of Illustrations. If he has been the culprit of such architectural crimes, look elsewhere, or see how cooperative he would be about acting otherwise on your house.
5. See if he has a thorough **understanding of the building codes** affecting your project. Find out some basic information from the City, and then quiz him on it in a naive way. See if he knows the answer, and see whether he talks down to you, or explains it comfortably. Find out if his services include acquiring necessary permits for you.
6. Once you have narrowed the list down, **get competitive bids in writing from different contractors on the same set of written specifications**. Tell each one exactly what you want, the quality of materials you expect, the time frame, and the fact that they are in competition. Write it down. If a contractor suggests adding something, have him bid that separately. The lowest bid may not be the best bid. Throw out any excessively high or low bids, and decide among the mid-range by using the first five factors listed above.

Similar rules apply in the selection of an architect, if your project warrants one. Get recommendations, make sure the two of you can communicate, and evaluate his or her experience on similar projects. Typically, an architect's work is in two parts: the preliminary design drawings to arrive at mutual agreement and show to the banker, and the working drawings for the actual construction. The architect's fee for rehab jobs is usually 15%, or more, of the final construction cost.

Drafting a Contract

Once you have selected a contractor or an architect, **define your mutual obligations in a legal contract**. Although consultation with a lawyer is generally preferable, most contractors have a standard form, or you can get one for 60¢ from the American Institute of Architects-East Bay Chapter, 315 14th Street, Oakland. The contract should safeguard your interests and include:

1. The **work** the contractor agrees to do, including dimensions, specifications, type and quality of materials.
2. The date the work is to begin, and a **time schedule** of how the project is to proceed, until its completion.
3. A schedule of **payments** in pace with the work, with 10-20% to be paid after you have inspected the final product.
4. A precise description of the **appliances** or fixtures to be bought if any.
5. Responsibility for **cleanup** and removal of debris, like a requirement that the contractor leave the premises "broom clean" daily or at stated intervals.
6. Release for you from **liability** should the contractor go bankrupt before he has completed your work. Otherwise, under the mechanic's lien law, an owner can be held accountable for any money owed by the contractor for labor or materials used on the owner's project.

If you are using a standard form and these, or any other items you are concerned about, are not listed, write them in. As long as the additions are neither illegal acts, nor prohibited by laws governing public funds used for the loan, the amended contract is valid when both owner and contractor sign. It is also advisable to double-check your homeowners insurance policy and your mortgage before signing the contract, as these documents may have clauses pertinent to remodeling or improvement of the property.

Never sign a Certificate of Completion until after the final inspection and until the job is finished to your satisfaction. Otherwise the certificate entitles

the contractor to final payment, and it will be difficult to get him to return and correct his errors.

Finally, be understanding of the professional's problem's too. Contracting is a nerve-wracking business, and a little sympathy on your part will probably go a lot further than perpetual nagging or accusation.

IS YOUR HOUSE UP TO CODE?

How to Determine the Applicable Code

Construction in the City of Oakland is regulated by a body of legal documents called codes. All dwellings are governed by the code in effect at the original date of construction, or what is known as the "applicable code." This is extremely important when you REHAB RIGHT because you are permitted by law to rebuild parts of the house exactly as they were originally. With a few exceptions, the contemporary codes are not retroactive and you are not required to change any parts of the house to meet modern standards. To find out what year your house was built, consult Chapter 2 for a general estimate, or the City Building Department, for more specific records. Their files go back to 1906.

Although an Oakland building code had been adopted as early as 1906, it made no specific provisions for residential construction. Thus, the applicable code for single family dwellings built before 1923 is determined by what was there originally, a handful of retroactive regulations in the 1923 State Housing Act, and the retroactive regulations in the 1977 Oakland Housing Code explained below. This is a real boon to REHAB RIGHT since the law, in essence, encourages you to respect the architectural character of the house. Make sure that the building and housing inspectors see what was there before you rip it out and reconstruct. Take photographs as evidence, in case problems arise later on.

CATEGORIES OF APPLICABLE CODE

Pre-1923



Borderline (Check Date)

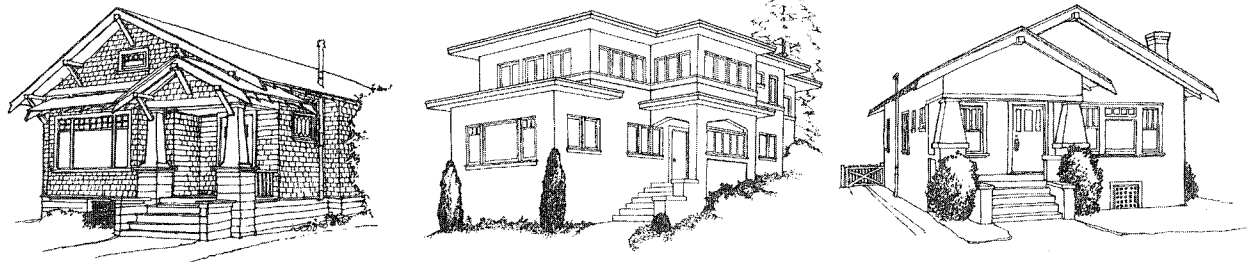

1923-1948

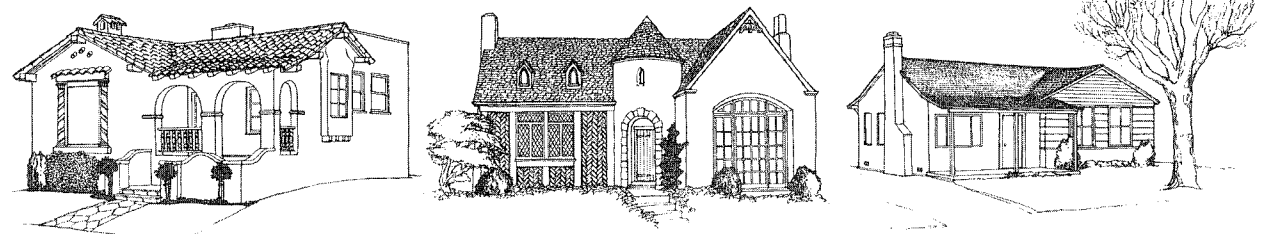

In 1923, the *State Housing Act* established standards regulating light and ventilation room size, ceiling height, exits, and the like, for single family dwellings. It also included retroactive regulations governing houses built prior to 1923, pertaining generally to sanitation, plumbing, gas vents, roofing, and air space in sleeping rooms. **The applicable code for all single family dwellings built between 1923 and 1948, is the 1923 State Housing Act plus the retroactive portions of the Oakland Housing Code explained below.**

In 1948, the City of Oakland adopted the *Uniform Building Code*, and in subsequent years, amendments to adapt it to Oakland and bring it up to date. **The applicable codes for dwellings built since 1948 would be the version of the building, electric, plumbing, mechanical and housing codes in the effect at the date of construction.** Currently, new construction is regulated by five codes adopted by the City Council to ensure safety for the occupants and a basic level of quality for the City's development. They are the:

1977 Oakland Building Code (1976 Uniform Building Code plus 1977 Oakland amendments)

1971 National Electric Code (1978 National Electric Code to be adopted shortly)

1974 Oakland Plumbing Code (1973 Uniform Plumbing Code plus 1974 Oakland amendments)

1974 Oakland Mechanical Code (1973 Uniform Mechanical Code plus 1974 Oakland amendments)

1977 Oakland Housing Code

The *1977 Oakland Housing Code* includes several **retroactive regulations for all single-family houses**, regardless of applicable code. It requires:

- fire resistive walls between an attached garage and the dwelling
- a handrail 30" - 34" above the nosing on any stairs with four or more risers
- two handrails, as described above, on any stairs that are more than 44" wide
- a smoke detection system, to be installed in conjunction with any rehab work worth \$1000 or more, or when the building is sold

- two means of egress (either a stairway or fire escape) from the topmost story to the second story of houses with three or more stories.

Also retroactive is an interpretation by the Housing Conservation Department of Title 25 of the California Administrative Code by which **the City may require improvements to electrical and plumbing systems**, even if they do meet the code in force at the time they were installed.

In addition, it is the policy of the Building Department to encourage that **rebuilt stairs conform to modern code**. In some cases this is detrimental to the architectural style, and is worth a firm stand on your part to reproduce the original design. Italianate houses, for example, typically had risers higher than modern code permits, but in perfect proportion to the rest of the building. A precise reproduction of the original is permitted by law. (See Chapter 5, "Staircase.")

Good news for the few people who will be moving a house and continuing its residential use is that thanks to state legislation, relocated houses are now primarily judged by applicable code rather than by modern code, as was the case prior to 1978. Modern standards will only apply to the foundation and the utility systems of relocated structures.

Copies of current codes are available at the Science and Sociology desk of the Oakland Public Library, 14th and Oak Streets. The *1977 Oakland Building Code* can be purchased at the Permit Counter on the 11th floor of City Hall for \$23.75, while the supply lasts. It is expected that the other volumes will be for sale there too, beginning in the summer of 1978.

Compliance Letter

Building codes are used to evaluate older buildings by the Housing Conservation department. A **Housing Representative will prepare a Compliance Letter which enumerates all violations of the applicable code for a fee of \$50**. A Compliance Letter may be initiated:

- by the City for vacant and unsecured buildings
- by the City for all buildings in a project area (like Clinton Park in 1962)

- by the loan applicant in conjunction with an HMIP loan (fee waived)
- by the loan applicant, in the future, in conjunction with the Marks-Foran program (fee waived)
- by the lender or guarantor, with the seller's approval, as a prerequisite to the Certificate of Occupancy (MGIC, FHA, and VA loans usually require this)
- by tenants or neighbors who suspect code violations
- by the owner him or herself to help direct home improvement.

The law requires that all infractions cited be corrected, but there is no time frame established. The City requires correction of safety hazards first. If a structure has been declared "substandard" by the Housing Official, then either the infractions must be corrected or variances must be granted by the Housing Advisory and Appeals Board before the Certificate of Occupancy is issued.

After the Compliance Letter is issued, the owner attends to the repairs through the permit process described below. Following the final permit inspection, a Housing Representative visits the property to make sure that the violations cited in the Compliance Letter have been corrected. If so, a **Certificate of Occupancy** is authorized and issued by the Building Official. The "C.O.", as it is called, is a **statement by the City of Oakland that the building meets all applicable codes**. The fee for the Compliance Letter includes the C.O. as long as the work is completed, or substantial progress is made, within six months. In the near future, the C.O. may be modified to mean that the building meets the modern housing code. Watch the local newspapers, or check with the Office of Housing Conservation. If this change is made, a variance procedure will be instituted to allow preservation of valuable architectural features.

Permit Fees
For Activities Typically Associated With Residential Rehabilitation
 Excerpts from the *City of Oakland Master Fee Schedule, May 29, 1979*

Permit	Permit Fee	Checking Fee (60% of permit fee)
Building Permit		
\$1 to \$1,000 Construction Value	\$20.00	—
\$1,001 to \$1,500 Construction Value	\$27.50	—
\$2,001 to \$20,000 Construction Value	\$35.00 first \$2,000 \$ 3.50 each additional \$500	\$16.50 \$23.10 to \$96.60
Demolition Permit		
	\$30.00 first story \$ 5.00 each addition story	
Reroofing Permit		
	\$10.00	
Building Moving Permit		
	\$100.00	
Electrical Permit		
Basic Fee	\$10.00	
Inspection	\$ 5.00/inspection	
Additional fees:		
Inspection of Residential Appliances, Light Fixtures, and Outlets	\$.25 to \$5.00 each	
Inspection of Circuits	\$ 1.00 each	
Inspection of Electrical Service	\$10.00	
Electrical Survey Inspection	\$16.25/hour	
Special Inspections as required by <i>Oakland Municipal Code</i>	\$15.00 to \$50.00	
Plumbing Permit		
Basic Fee	\$10.00	
Special Inspection	\$18.00/hour	
Inspection of specific fixtures, devices, pipes, sprinklers, etc.	\$ 5.00 to \$7.50 each	
Each additional inspection	\$15.00	
Mechanical Permit		
Basic Fee	\$10.00	
Special Inspection	\$18.00/hour	
Inspection of specific heating equipment, furnace, range, radiator, exhaust, boiler, etc.	\$ 7.50 to \$25.00 per fixture	
Each Additional Inspection	\$15.00	
Microfilm Surcharge		
	1% — 2% of permit fee	

**PERMITS ARE A BONUS, NOT
A BURDEN**

Before any building project gets underway, the property owner or licensed contractor must secure one or more permits required by City law. The permit process guarantees that work will be done in accordance with code while providing the applicant with a plan check and work inspections by City personnel competent in their assigned fields.

A **building permit** is required for all new construction; for additions, alterations and repairs; for demolition; for swimming pools; for fences over 6' high and retaining walls over 3' high; for awnings, re-roofing, and signs. Apply at the Permit Counter, 11th floor, City Hall, 1421 Washington Street, between 8:00 a.m. and 4:30 p.m., Monday through Friday. The permit fee is graduated as the value of construction increases.

A **plumbing permit** or **mechanical permit** is required for all plumbing and mechanical work, except minor repairs. Apply at the Plumbing Inspection Division Counter, 11th Floor, City Hall, between 8:30 a.m. and 4:00 p.m., Monday through Friday. The application fee is \$10, with an additional charge for each fixture or pipe inspected (typically \$5.00 apiece).

An **electrical permit** is required for any electrical work other than minor repairs. The property owner or an eligible licensed contractor who is registered with the City's Electrical Inspection Division may apply at the Electrical Inspection Division Counter, 11th floor, City Hall, between 9:00 a.m. and 4:00 p.m. The minimum fee is \$15.00 with additional fees for inspection of specific appliances, circuits and outlets, ranging from 25¢ to \$5.00 apiece.

If you have any question at all about whether a permit is required for any part of your rehab job, don't hesitate to telephone the **Inspectional Services Department** at **273-3441** between 8:00 a.m. and 4:30 p.m. They are there to help you.

Permit applications for small jobs are processed at the counter while you wait. Many jobs, however, require a site visit, and even larger projects require that the plans be routed to several City departments

for review. Although it may take anywhere from a half-hour to two weeks to issue a building permit, **it usually only takes one or two days to issue a permit for a typical rehab job.** The fee is paid at the time the permit is issued.

Once the permit is issued and work has begun, inspections are arranged to confirm that construction is proceeding according to plan. **Call in for an inspection (273-3441) before any construction is permanently concealed.** Studs, for example, should be inspected before wall covering is installed. A final inspection is required at the conclusion of the job.

There are professional inspectors for each type of permit, and each inspector handles a specific district in the City. There are eight Building Permit districts, six electrical districts, five plumbing, and two mechanical. If your rehab project involves all four types of permits, then you can expect four different, specialized inspectors to come by. When the inspector calls, remember that you will be seeing the same man again as the project progresses, so be as cooperative as you can.

If you have a serious disagreement with the inspector, your recourse is to call his supervisor. This may come up when you are trying to REHAB RIGHT because the inspector may not think that some architectural feature you are set on saving is up to code. The interpretation of the "applicable code" rule is often confusing when it comes to historic house parts. If the inspector wants you to modernize against your will, resort to the person with more authority, and explain the situation calmly. Do not hesitate to demand, in writing, an interpretation of the code in question.

If all else fails, you can bring your issue before the appropriate review board. The Board of Examiners and Appeals hears cases pertinent to the Building Code, and resolves questions regarding construction methods and materials. Contact them through the Inspectional Services department. The Housing Advisory and Appeals Board hears cases pertinent to the Housing Code, and resolves questions regarding building configuration. Contact them through the Housing Conservation department. On both boards, the Fire Marshall sits *ex-officio*, and

whichever side of a case the fire marshall and city staff are on, is the side that's likely to win.

TERMITE REPORTS

Wood frame houses are subject to infestation by structural pests, especially if the wood members are in contact with the soil or if moisture has been permitted to accumulate in the wood. The most infamous of these pests is the termite, but fungus, rot, powder post beetles, and carpenter ants also pose a serious threat to wood structures. (Refer to the section on wood porches in Chapter 4 for a list of the danger signs.)

A licensed Structural Pest Control Inspector will evaluate the property for a fee of about \$65. The inspector prepares a termite report which ascertains the presence of structural pests, analyzes the damage, and recommends corrective and preventative measures, or what is commonly called the "termite work." Typically, a termite inspection takes place when a property is about to change hands, and is required by the lending institution and/or the buyer. The lender usually requires "termite clearance" which is a form signed by a licensed pest control operator certifying that "no evidence of active infestation, infection or adverse conditions were found." It often takes termite work to arrive at such a determination. The buyer usually requires that the seller pay for correction of the termite damage. The seller may do so directly, by hiring a termite contractor to do the structural work, or indirectly, by reducing the sales price of the house in a amount equal to the cost of correcting the damage.

The City may require a termite report and subsequent termite work:

- in conjunction with a Compliance Letter and the issuance of a Certificate of Occupancy
- to abate a serious safety hazard noted by a Housing Representative in the course of a general inspection or in response to a complaint
- in a project area that is undergoing a systematic inspection program.

Otherwise, **the City does not require that work**

itemized by a termite report be undertaken.

Although some termite work is limited to the removal of debris from the crawl space, or a minor change in grade to allow a 6" clearance between soil and wood, most termite work is structural in nature and requires a building permit. **A regular contractor, with a B-1 license, is not authorized by law to perform structural pest control work,** and will not be issued a building permit by the City to do so. Nor is a B-1 licensed contractor permitted to issue a termite clearance once the structural work is completed. Only a licensed structural pest control operator may perform these operations, and he must file a copy of the termite report with the permit application. The Inspectional Services Department has records of termite reports dating back to the late 1930's, if you choose to investigate the structural history of your house.

Selecting a Structural Pest Control company requires comparative shopping and powers of observation. There are seven pages under the heading of "Pest Control" in the Telephone Directory "Yellow Pages," but only some of those listed are licensed in the treatment of wood destroying organisms and appurtenant structural repair. (The others are licensed in either fumigation or general pest control.) Look for the key phrase "termite inspections and structural repair." It is especially important to check around and get recommendations of companies with an honest reputation since the contents of a termite report are a matter of professional judgement. In fact, a discrepancy in the cost of recommended repairs is fairly predictable when two reports are ordered for the same property, especially if one is requested by the buyer and the other by the seller.

Contact the State Board of Structural Pest Control to find out if any complaints have been registered against the operator you are considering, and the disposition of any complaints received. The Board will also provide mediation services, at no cost to the consumer, if there is a marked inconsistency between the reports of two companies. Send the Board a letter at 1430 Howe Avenue, Sacramento, 95825 or telephone them at 916-920- 6323. Likewise, you can file complaints against a structural Pest Control company with them, and seek redress.

EARTHQUAKE SAFETY

The major damage to structures and the most readily apparent sensation felt by people during an earthquake is caused by ground shaking. Consult Chapter 4 for information on quake-safe foundations. In addition, simple precautions which can reduce the hazard should be incorporated in your rehab plans:

1. Know where the **turn-off valves** are for the building's water and gas supply. Keep a wrench handy in case the valve is sticky.
2. Strap the **water heater** to the wall with a metal strap, or bolt it to the floor. Otherwise it is likely to fall over in an earthquake, rupturing gas lines and/or water lines.

3. Tall, free-standing **bookcases or cabinets** should be anchored to wall studs with metal tie straps or steel angles. Keep the heaviest and most valuable items on the lower shelves. Consider adding a guard rail to the shelf edge to prevent items from sliding off. Make sure cabinet doors close tightly.
4. Hang **pictures** on hooks screwed into studs, not just into plaster. Never hang pictures or other objects over the head of the bed. Ceiling mirrors are extremely dangerous.
5. **Keep the exit area clear** of large bookcases, breakable items, or anything else that might block the path and make an emergency exit more difficult, especially in the dark.
6. Be extremely cautious of **chimneys**. During or shortly after an earthquake, the mortar of older

chimneys may disintegrate, and the bricks topple over. The top of the chimney above the house may come crashing through the roof. Keep beds away from that area, and determine an exit route which will not take you near the chimney.

7. Be mentally prepared for an earthquake and learn basic first aid procedures. Keep an **earthquake emergency kit** in what should remain an accessible location even after groundshaking. The kit should include:

- flashlight with extra batteries
- transistor radio with extra batteries
- first aid kit
- several days food supply
- plastic-bottled water
- portable fire extinguisher. 

Chapter 4.

EXTERIORS

FOUNDATION

A sound foundation is the basis for all rehabilitation work because a weakened foundation threatens the very structure of the house and all of its valuable architectural features. The foundation accepts the weight of the structure and distributes it evenly to the surrounding soil. In Oakland it is typically made up of: the masonry perimeter wall which bears most of the load; the interior piers and posts for supplementary support; the sill plate which connects the masonry of the foundation with the wood frame of the house; and anchor bolts to secure this connection. Some buildings will have earthquake anchors for protection from that hazard.

Settlement is the major threat to the foundation. When the ground beneath the building moves, the foundation responds to the movement and adjusts to the new lay of the land. Since solid masonry is not flexible, the change in position causes cracks in the foundation walls. As these imperfections become larger due to more movement or the erosive forces of weather, the foundation loses the strength it needs to support the rest of the house.

Settlement is an anticipated one-time occurrence in new houses. In older buildings, it may be caused by:

- inadequately compacted fill
- landslide, slough or slippage
- flooding
- a clay subsoil which has dried out and shrunk
- deficient drainage or waterproofing

- rotting or drying timbers
- roots of large trees.

Running cracks on the foundation, around door tops, sills and window frames, are an indication of settlement trouble. To determine whether the movement has stopped, glue a strip of paper across the crack using a contact adhesive. Or, use plaster of paris or two pen marks, instead of the paper strip. If the paper tears within 2-4 weeks, consult an engineer or contractor. Remember that an engineer sells only advice, while a contractor sells advice and construction services both, so the price paid for the engineer's fee is your guarantee of an objective evaluation.

Oakland's earliest homes, built between 1840 and 1870, were constructed with no masonry foundation at all. Instead, a wood "mudsill" was placed directly on a patch of levelled earth, and the frame walls attached directly to it. Sometimes flat stones, without mortar, were used as a footing to raise the wood sill slightly above the ground. If either situation persists, the foundation should be replaced with concrete.

The two common types of masonry foundation in Oakland are brick and concrete. The use of brick began in the 1860's, and its popularity continued through the 1920's. Concrete foundations were introduced in about 1906, and their use, in various forms, continues today.

Brick Foundation

To inspect a brick foundation, look for these trouble signs:

- cracks between the bricks, especially cracks running diagonally across the wall
- loose and powdery mortar (scrape the mortar with a penknife or a screwdriver—the mortar should be firm and solid)
- crumbling bricks
- uneven settlement of the foundation wall (the bricks should be level from one corner to the next).

If you find very large cracks or severe settling prob-

lems, have a civil engineer or a contractor look at the foundation.

Repair cracks between bricks and crumbling mortar by a technique called "repointing." To repoint:

1. Remove the old surface mortar to a depth of $\frac{3}{4}$ ", being sure to clean out all of the loose mortar and clean off all dust.
2. Dampen the joint to keep it from drying out prematurely, and apply mortar so that it fills the space of the original mortar.
3. Smooth it with a trowel, making the new mortar joint match the old one in size and design. This may require a special striking tool.

HOW TO REPOINT

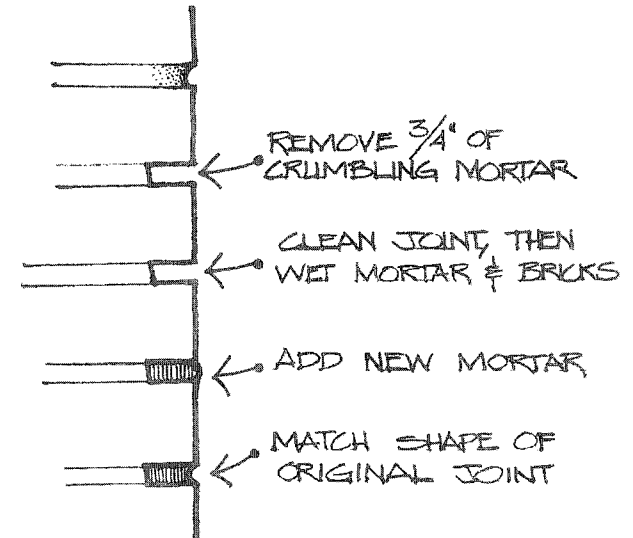

Be careful to select a mortar that is the same color and strength as the original. The new mortar should be slightly darker than the old mortar when both are wet because the new mortar will get lighter as it dries. Vinyl cement, though easier to apply, never matches the original mortar. See your building supplier for recommendations on mortar mixes and equipment.

Be sure to use bricks that are the same length, width, height and color as the original ones and,

TYPICAL MORTAR JOINTS

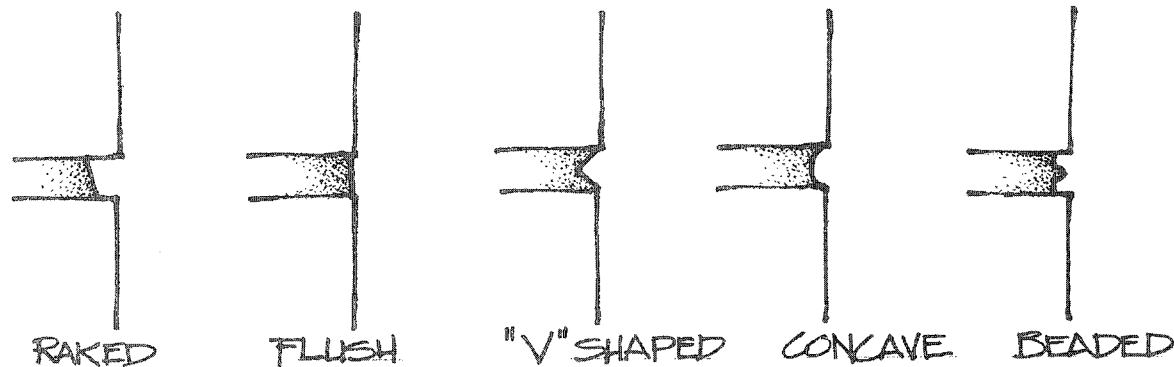

of course, be sure to install them in the same pattern. If you don't, your hard work will be an obvious "patch job."

Craftsman houses are known for their **clinker bricks** in foundation, fireplace, and chimney. These are irregular, unevenly fired bricks which

manufacturers used to discard as rejects. Although clinker bricks were available as late as the 1950's, the only way to find legitimate replacements today is through a wrecking company. Try to replace clinker brick in kind, but if it's impossible, use a modern substitute called "flashed brick." Flashed brick is geometric in shape, like a conventional

BRICK PATTERNS

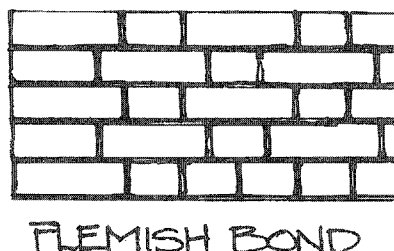
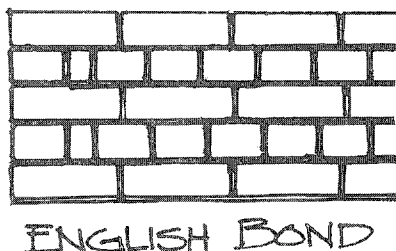
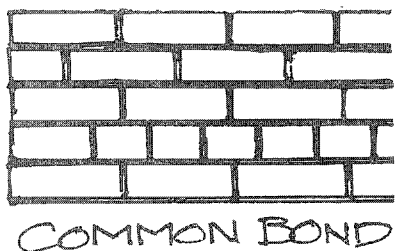
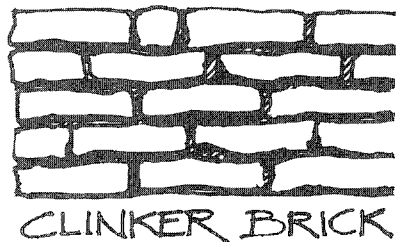
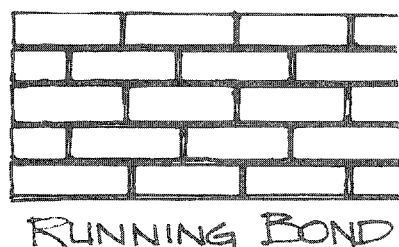

brick, instead of gnarled and pitted like its clinker ancestor. However, it is chemically treated to show dark stains like its original counterpart. Flashed brick is available through local brickyards like Morgan Bros., Barrick-Stonecraft, and Western State Stone, on a sporadic basis. To find out when and where they are in stock, call the manufacturer's dispatcher at L.P. McNear in San Rafael or Port Costa Brick in Port Costa.

There are a few houses in Oakland built entirely of brick. The danger signals and repair techniques for brick foundations apply generally to brick structures too.

Concrete Foundation

Look for cracks in a concrete foundation as evidence of uneven settlement. To differentiate between simple cracks which can be patched by an amateur and major cracks which are the result of movement in the masonry, conduct the paper strip test described above. Repair minor cracks by scoring the concrete and filling it with concrete patch cement, available in small packages.

If a new concrete foundation is required due to uneven settlement, wood resting directly on the ground, or a thoroughly deteriorated brick foundation, turn the project over to a professional contractor. A new concrete foundation for a 1,500 square foot house (25' x 60') on a flat lot, will cost about \$1600, or a little over \$10 a linear foot. In addition, it costs as much as \$3 per square foot of floor area to shore up the building while the concrete foundation work is underway, or an additional \$4500 for the case in point. This fee is lower if the work can be done in sections instead.

Another problem encountered in concrete foundations is **chipped corners**. This is a basic repair which the homeowner can handle, quickly improving the appearance of the house by eliminating a shabby feature.

When replacing a portion of a brick foundation with concrete, or when installing a new or additional concrete foundation, the new and the old must be tied together.

CONCRETE CORNER REPAIR

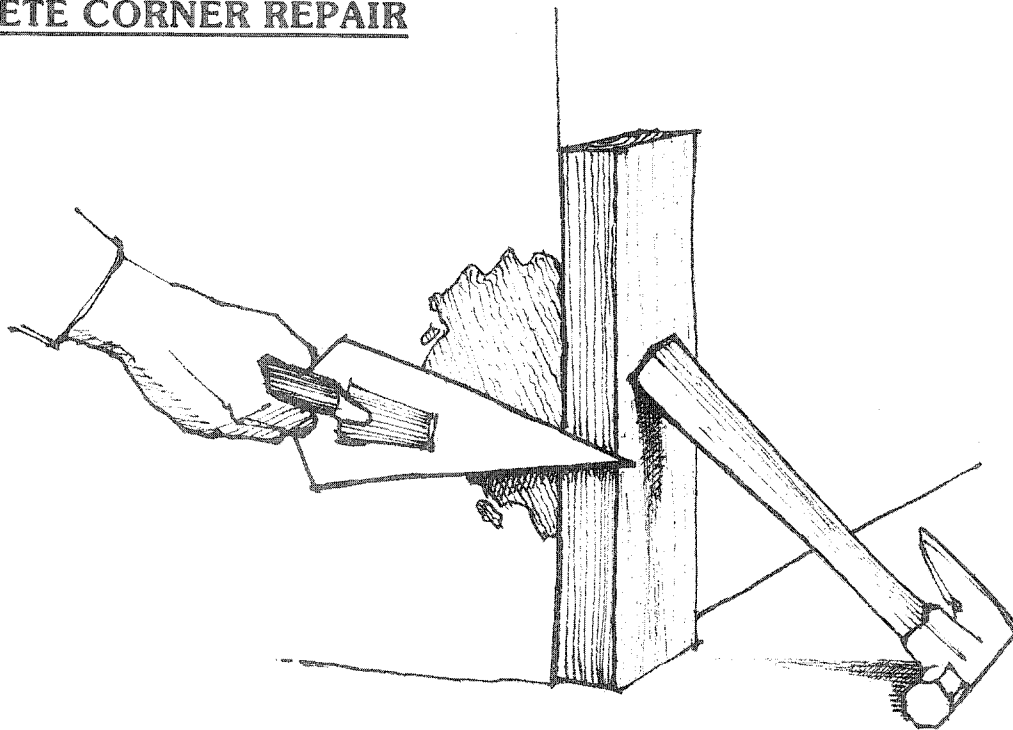

- A. REMOVE LOOSE PARTICLES WITH A STIFF WIRE BRUSH.
- B. WET CHIPPED AREA THOROUGHLY.
- C. PROP A 2x4 AGAINST ONE SIDE OF THE CORNER. FILL CRACK WITH PATCHING CEMENT, THEN SMOOTH FLUSH WITH A TROWEL.
- D. PROP THE 2x4 AGAINST THE OTHER SIDE OF THE CORNER. USING THE 2x4 AS A GUIDE, SLICE OFF EXCESS CEMENT THAT MAY STICK OUT BEYOND THE CORNER.
- E. LEAVE 2x4 IN PLACE 4 HRS OR MORE.

Posts and Piers

Most Oakland house styles which pre-date World War II have one or more rows of wood posts on concrete piers for intermediate support underneath the building. If any of the posts show signs of decay, or if the wood is in direct contact with the ground, then new wood posts treated with a preservative should be installed on concrete piers. The new posts should be the same size as the older ones were.

Wood posts that are exposed to the weather, as on rear porches or front stairs, should be separated from the concrete footing by an air space. Otherwise, this is one of the most common places for dry rot to occur. Without the air space, water sits on the wood plate, working its way into the end grain of

POST AND PIER ELEVATION

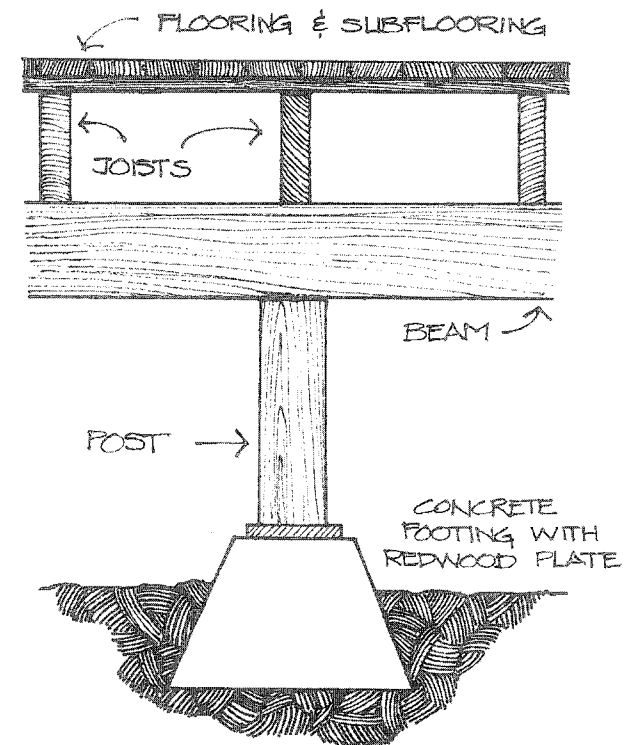

POST AND PIER CONSTRUCTION

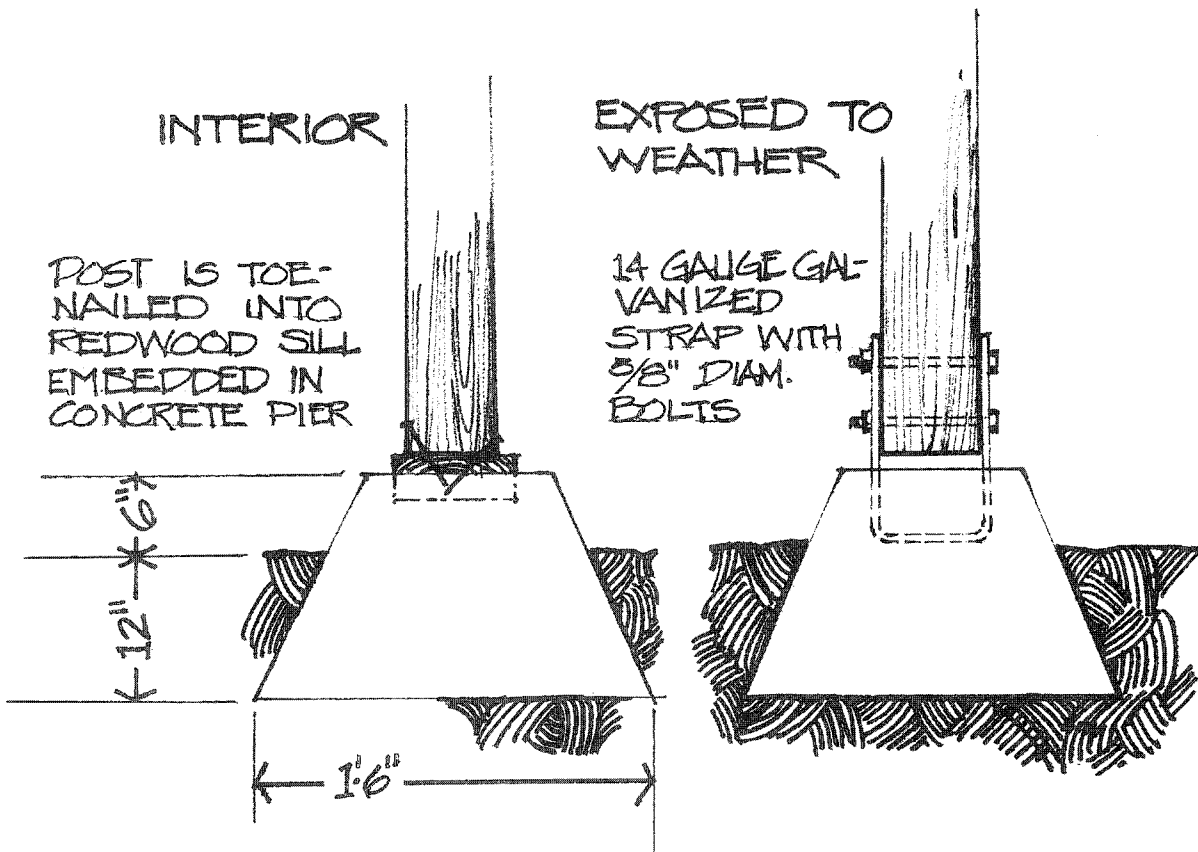

the post and rotting it. The construction detail for exterior wood posts and piers is more difficult and expensive to construct than its interior counterpart, but the extra durability makes it worth the trouble and expense.

Sill Plate

The sill plate is a horizontal wood member which acts as intermediary between the house frame and the masonry foundation. It is the counterpart to the redwood plate which sits atop the concrete piers on interior posts, as illustrated in the previous section. In older buildings, the sill plate must be replaced

if it has been decayed by moisture accumulation or decimated by termites or rats.

Anchor Bolts

Anchor bolts fasten the sill plate to the foundation. An expansion bolt (so named because it becomes wider as it is tightened) is inserted in the mortar of brick foundations, and embedded directly in concrete foundations. Many Oakland houses have brick foundations without anchor bolts, a very serious liability in the case of earthquakes. The technique for anchoring an older home to its foundation is illustrated.

Seismic Anchor

In the course of foundation repair, consider the addition of seismic anchors. These are steel brackets or bent steel plates which bolt together the foundation, the sill, and the wall studs. They should be installed at all corners of the house to prevent the wood frame from "hopping off" the masonry foundation during an earthquake.

ANCHOR BOLT

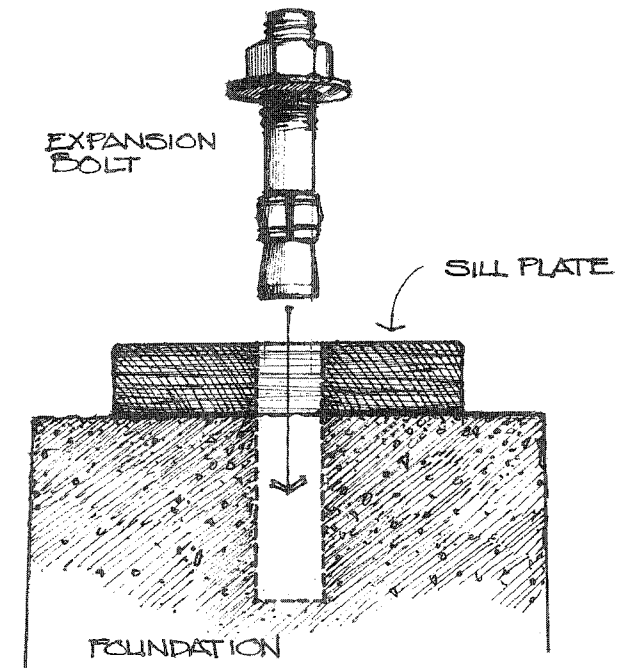

SEISMIC ANCHOR

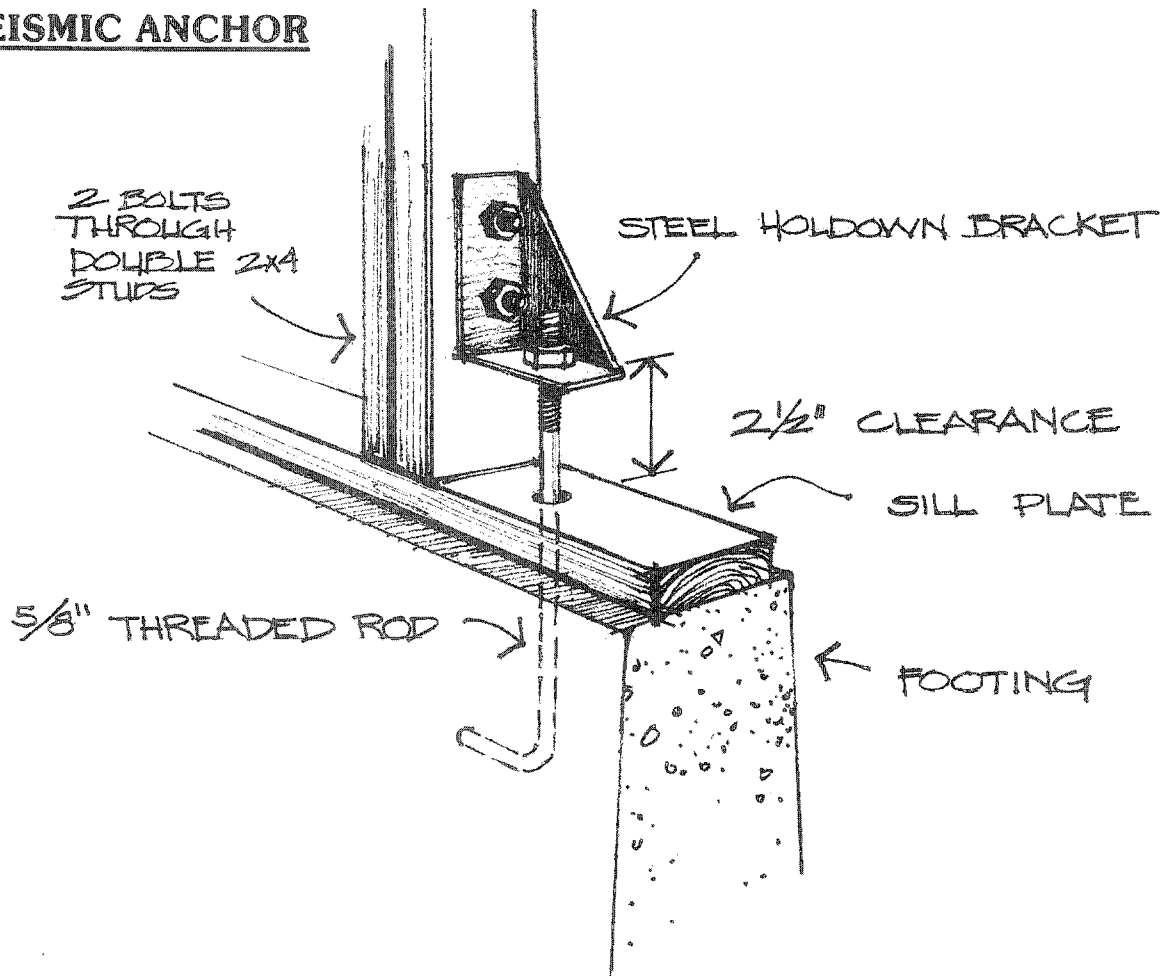

CRAWL SPACE

Crawl space is found in buildings without an excavated basement. It is the space between the ground and the bottom of the first floor. The crawl space is highly susceptible to moisture retention, a condition which is both destructive to the structure and uncomfortable for the residents.

Clearance

The Oakland Building Code requires that the foundation provide adequate clearance between the ground and the wood members of the house so that termites and beetles will not make your home

their home. Make sure there is at least:

- 6" of clearance between the ground and any wood sill or siding which rests on the masonry foundation
- 18" of clearance between the earth in the crawl space and the bottom of the floor joists
- 12" of clearance beneath any beam supporting floor joists
- 6" between wood posts resting on concrete piers and the earth.

Keep the crawl space cleared of debris.

Vents

Vents in a crawl space provide air circulation which inhibits moisture build up. There should be one vent for every 150 square feet of ground area, placed opposite each other to maximize cross-ventilation. Keep the vents open year round.

For greater moisture control, a layer of roll roofing (15 lb. felt underlayment, at \$7.99 per 300 square foot roll) or polyethylene sheeting (4 mils thick at

VENT STYLES

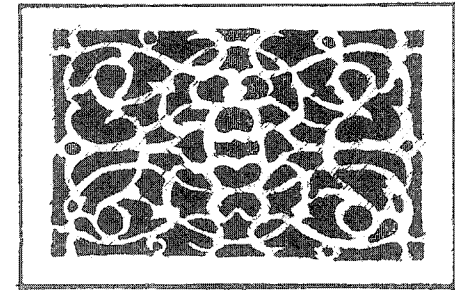

VICTORIAN - CAST IRON

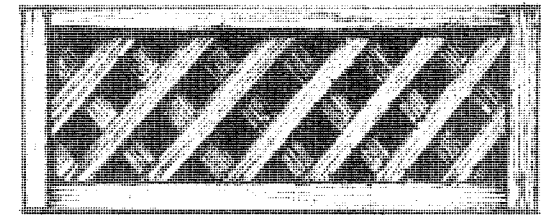

REDWOOD LATHE

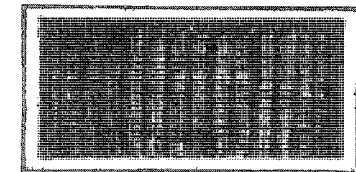

METAL SCREENED

CRAWL SPACE CLEARANCE

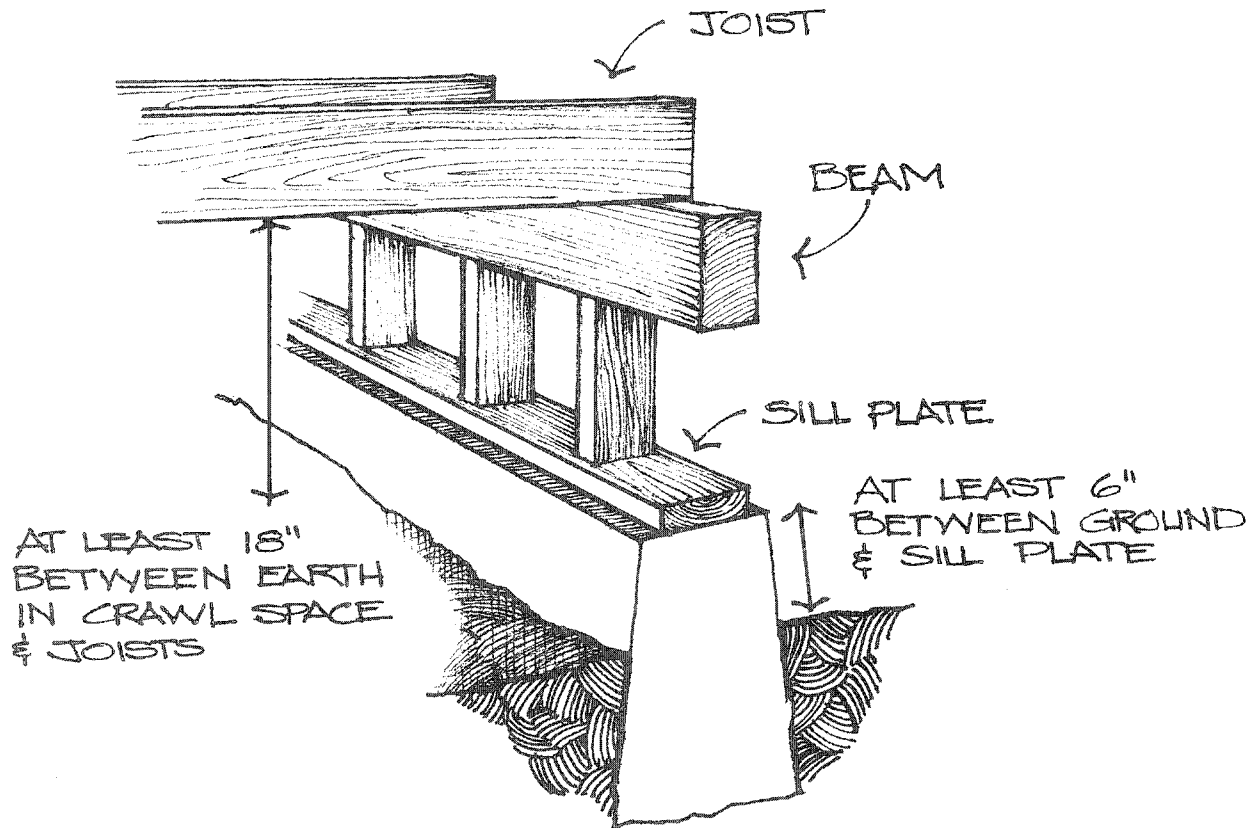

\$5.89 per 10' × 25' roll) can be spread across the ground in the crawl space. If so, the number of vents can be reduced to one per 1500 square feet. However, two vents placed opposite each other are the absolute minimum for adequate air flow.

Different vent designs are associated with specific architectural styles and **the original vent should be retained** whenever possible. Victorian homes have ornamental cast-iron vents. Their floral or geometric patterns allow the air to enter the crawl space and at the same time decorate the building. The vent **design** is often masked by layers of paint and grime which can be stripped fairly easily.

1. Place the grate on a piece of aluminum foil with the sides rolled up. Brush on a paint remover, like Jasco, and let it sit for several hours. The foil does not absorb the paint remover the way other protective surfaces, like newspaper, would.
2. When the Jasco has had a chance to do its job, hold the vent by tongs or with rubber gloves—always protect your skin from paint remover—and hose or scrape off the gummy surface.
3. If paint still adheres, repeat the process.
4. Use steel wool to rub off the final specks.

Now that the crispness of detail has been restored,

the vent is ready for a protective primer and a fresh coat of paint.

Brown Shingle houses and Craftsman Bungalows have vents made of criss-crossed redwood lath. Unfortunately, this design is susceptible to rot and may allow entry to rodents and other pests. Houses with wood siding at ground level have holes drilled through the siding in lieu of a more conventional vent. Air flow there may be insufficient. Wartime Tract houses, and many buildings from the twenties, have galvanized metal mesh vents, and these may rust after several years and require replacement.

Vent openings should be no larger than $\frac{1}{4}$ " square to successfully exclude rodents. To save an interesting vent which exceeds this standard, attach a screen to the inside of the vent. If the vent is neither operable nor noteworthy, use a screen vent alone.

Insulation

The solution of one problem is sometimes the cause of another. **When the crawl space has adequate ventilation, the floor above it may get chilly.** The solution then is standard insulation held in place by wire mesh underneath, stapled to the joists. The silvery sheet on one side of the insulation is called the "vapor barrier" and it faces up. Fiberglass batting, $3\frac{1}{2}$ " thick, costs about 15¢ per square foot, or \$225 for a 1500 square foot house.

STAIRS

Outside entry stairs receive constant use and abuse from pedestrians and the weather both. Although more durable materials like concrete and flagstone hold up the best, they are often most inappropriate to the architectural style. When repairing steps, don't forget the code requirements.

Wood Stairs

Deteriorated wood stairs are an extremely common problem on Victorian and Colonial Revival

CRAWL SPACE INSULATION

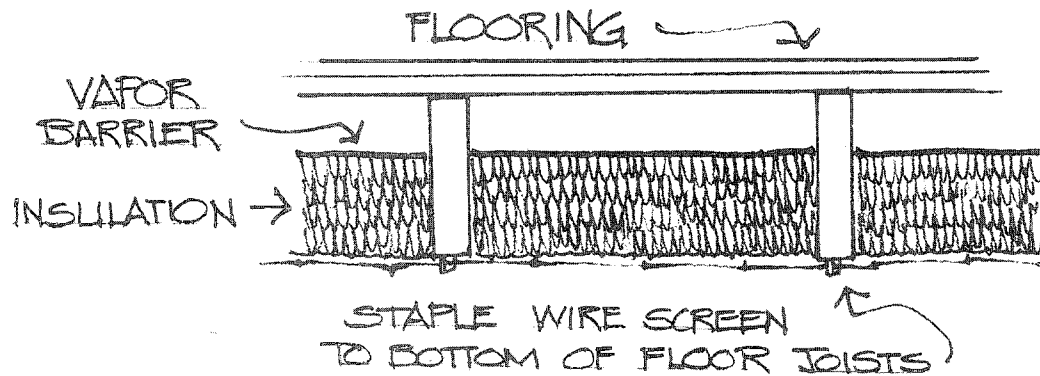

houses in Oakland, yet it is imperative for the building's architectural integrity to continue the use of wood and not give in to the temptation of concrete. After all, the wood steps on many a Victorian have lasted 90 years, so even if new wood steps last "only" another 90 years, it's perfectly adequate for your needs.

The source of wood step problems is poor drain-

STAIR DIMENSIONS FOR BRAND NEW CONSTRUCTION REQUIRED BY MODERN CODE

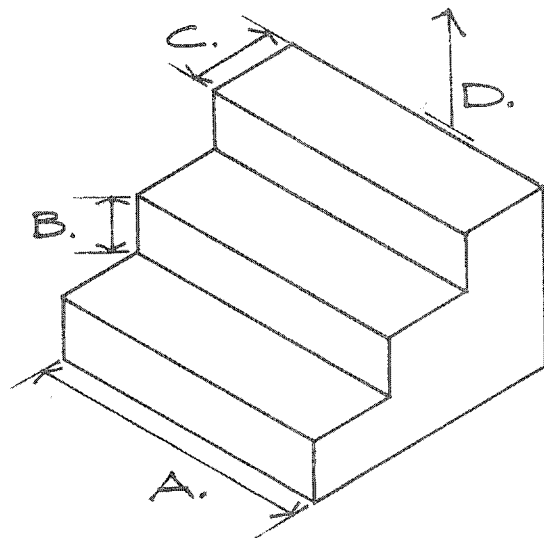

age. Even the smallest accumulation of rain can begin the rotting process. This may result from one or a combination of factors: solid boards installed perfectly flat; worn treads with a depression in the middle; lack of paint and caulk to provide a protective seal; or, adjacent features which pond water on the steps. Look for the symptoms of rot, as described in the section on wood porches.

When repairing wood steps:

- Consider turning worn treads over. A shallow depression switched to the reverse side will have no detrimental effect, and flipping the board will save money and time.

A. WIDTH: AT LEAST 30"
BUT PREFERABLY 36"
OR MORE

B. RISER HEIGHT: 7½"
OR LESS

C. TREAD WIDTH: 10",
MINIMUM

D. HEADROOM CLEARANCE:
7' MINIMUM

- Install new or recycled boards at a slight angle from front to back, say ⅛" per tread, as illustrated.
- Design the railing so that the balusters are attached to a handrail on top and free-standing shoerail on the bottom. This allows a space for the water to run off the edge after a severe storm. Refer also to the handrail illustration.
- Coat the treads with a wood sealer, like Olympic or Rez, prior to installation.
- Make sure the tread nosing projects ¾" - 1¼" over the riser, to keep the joint water-free, and to afford a shadow that is a definite design asset.
- Do not direct drainage water onto the sill plate underneath the steps.

Brick Stairs

Brick was introduced to Oakland as a stair material in the early stages of the First Bay Tradition and is typically found on Brown Shingle houses and Craftsman Bungalows. **Brick stairs do not belong on a Victorian house;** they are as anachronistic as concrete.

One problem encountered with brick stairs is settlement due to shifting soil support. To correct this, concrete must be injected beneath the existing structure, and additional bracing may be required. This is a difficult operation that should be executed by a qualified contractor.

Brick stairs are subject to cracked mortar joints. These require immediate attention in order to prevent water penetration which cracks and rots the mortar further. To repoint mortar joints, refer to the section on brick foundations.

Concrete Stairs

Long concrete stairs are commonly found on Prairie School houses and California Bungalows. Shorter ones, often only a step or two, are typical to the Period Revival style and Wartime Tract. Occasionally, concrete steps are embellished with redwood strips, mosaics, or tiles. Mediterranean and Provincial houses are known for their shiny, red, painted concrete steps and matching walks. Green

IMPROVING DRAINAGE ON WOOD STEPS

TO FACILITATE DRAINAGE, DRAW STANDARD STRINGER PATTERN ON BOARD, THEN RE-DRAW TREAD LINE SO INSIDE EDGE IS $\frac{1}{8}$ " HIGHER THAN OUTSIDE EDGE

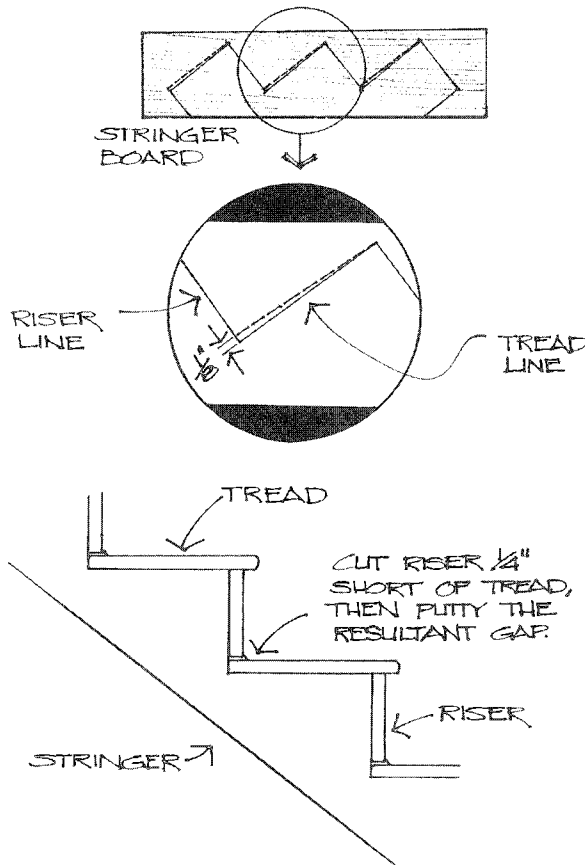

and grey are popular paint colors for bungalow steps. It's valuable to stick with popular colors because repetition lends visual unity to the neighborhood.

Another design aspect of concrete steps are the grooves. They may be geometric or abstract patterns, or parallel lines for skid proof purposes. The arrangement of grooves should be perpetuated

if the concrete is repaired, or reinstated if the stairs are replaced.

Concrete steps are subject to spalling, the chipping off of small pieces from the nose of the tread. This is repaired by using a high strength mortar to bond new concrete to the old. If the damage is severe, consider adding a steel angle plate with an anti-slip surface.

STEEL NOSING ON CONCRETE STEPS

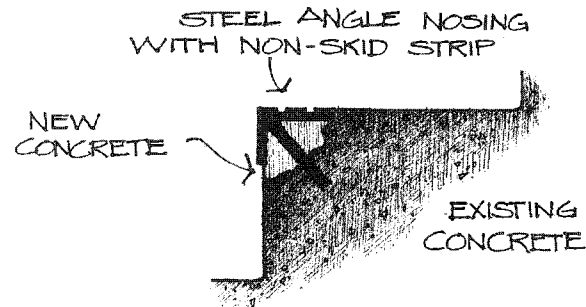

Small cracks in concrete steps are normal and can be repaired with concrete patching cement. Major cracks are a sign of uneven settlement or stress in the concrete, and should be investigated by a professional engineer or contractor.

Handrails

For new front stairs, the *Oakland Building Code* requires handrails on each side of the stairs that are 30" to 34" above the nosing. (Refer to the discussion of applicable codes in Chapter 3 and to the section "Staircase" in Chapter 5.) **The handrail design should be sympathetic to the architectural style of the house, the material of the original steps, and the design of the original porch railing.** For example, on a Victorian house the handrail should be wood with a sculptured feeling. Reconstruct the shapely silhouette by combining standard pieces of lumber and embellishing the composition with cove moldings. Do not use wrought iron. It looks totally out of place, like dime-store jewelry on a well-tailored dress.

The handrail on the Colonial Revival styles should be stepped, not diagonal. Although a stepped railing is more difficult to construct, its right angles and geometric proportions carry out the architectural theme. If you have a two-story Classic Box, use the bannister on the indoor staircase as a guide. It has two ballusters per tread, a design feature which could be imitated for the outside railing. (Refer to the section on Porch Railings and to the illustration in "Roof" entitled "Downspout Locations" for more examples of railing design.)

STAIR RAILING RECONSTRUCTION

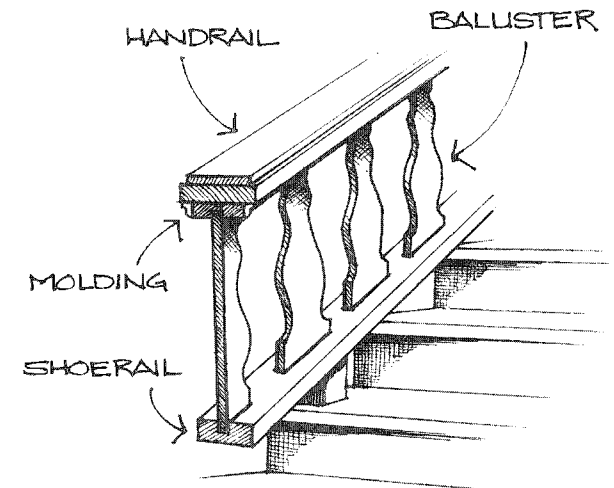

RECONSTRUCTED STAIR RAILING HAS FREE-STANDING SHOERAIL (CONNECTED TO EVERY 3RD OR 4TH STEP) TO ALLOW WATER DRAINAGE. THE SCULPTED LOOK OF ORIGINAL TURNED BALUSTERS IS SUGGESTED BY CUTTING FLAT BOARDS INTO A SIMILAR SHAPE WITH A JIG-SAW. A HANDRAIL BUILT-UP OF STOCK PIECES OF LUMBER & MOLDING IS CLOSE TO THE ORIGINAL HANDRAIL IN SIZE & APPEARANCE.

STAIR RAILING ALTERNATIVES FOR THE NEOCLASSIC ROWHOUSE

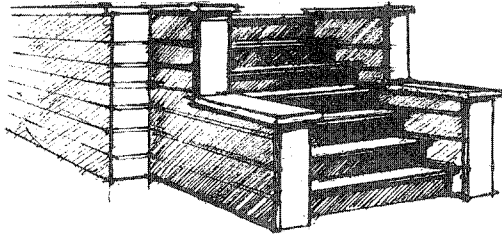

ORIGINAL DESIGN

VISUALLY & PHYSICALLY SOLID, USES CORRECT MATERIAL (WOOD), PROPORTIONS ECHO THOSE OF HOUSE.

ADDING HANDRAILS

WHEN REBUILDING STAIRS TO THE ORIGINAL DESIGN, CODE REQUIREMENTS MAY FORCE YOU TO ADD HIGHER HANDRAILS. ON SOME STYLES OF WOOD STAIRS (COLONIAL REVIVAL, CRAFTSMAN, OR WHEN THERE ARE BUILT-UP SIDES WITH OUT BALUSTERS OR HANDRAILS), YOU CAN USE INTERIOR HANDRAIL BRACKETS WITH CLOSET POLES OR 2x2 LUMBER FOR RAILS.

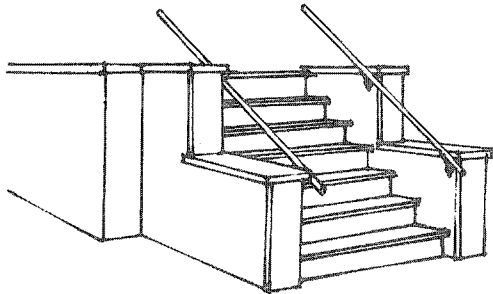

DESIGN INTEGRITY

THINK OF YOUR STAIRCASE AS AN EXTENSION OF THE HOUSE, UNIFIED IN STYLE, RATHER THAN AS A SEPARATE, REPLACEABLE COMPONENT. MAINTAIN OR RESTORE THE ORIGINAL DESIGN AND AVOID THE TEMPTATIONS OF READY-MADE WROUGHT IRON RAILINGS OR OVERSIMPLIFIED CONSTRUCTION TECHNIQUES.

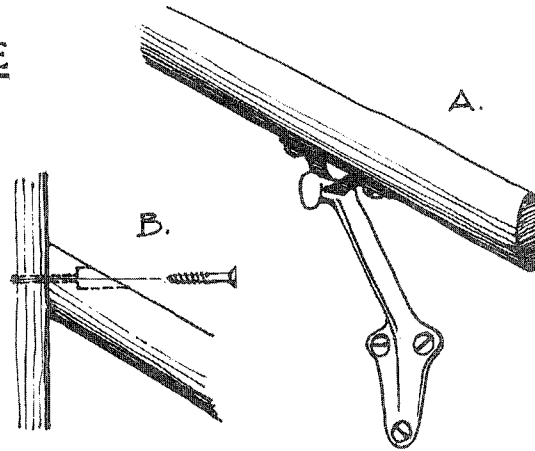

HANDRAIL DETAILS

- A. BRACKET WITH CLOSET POLE RAIL. (IF A 2x2 IS USED FOR THE HANDRAIL, CHOOSE A SMOOTH-FINISHED BOARD WITH ROUNDED EDGES.)
- B. ATTACH THE UPPER END OF RAILING TO WALL OR PORCH WITH A COUNTERSUNK WOOD-SCREW. DRILL PILOT HOLE FIRST.
- C. EXTRA HEIGHT CAN BE GAINED, IF NEEDED FOR CODE COMPLIANCE, FROM 2x4 EXTENSIONS.

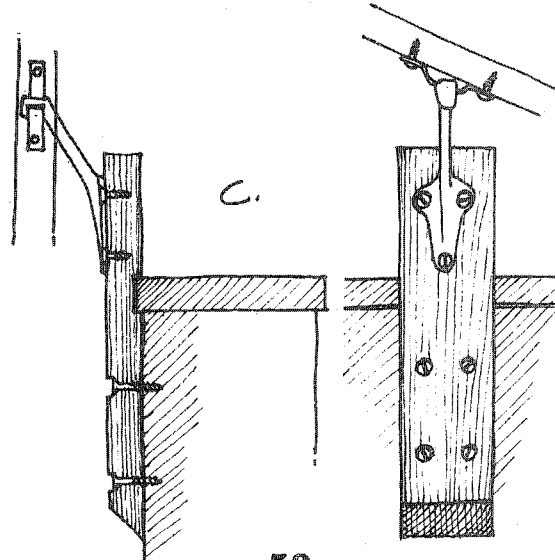

INAPPROPRIATE DESIGNS

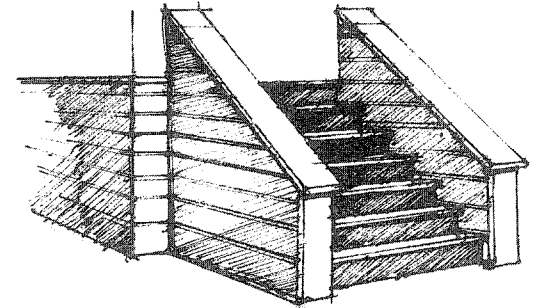

ANGLED SOLID RAILING

PROBLEMS: DOESN'T FIT SQUARE FEATURES OF STYLE, MAKES STAIRS SEEM NARROW & ENCLOSED.

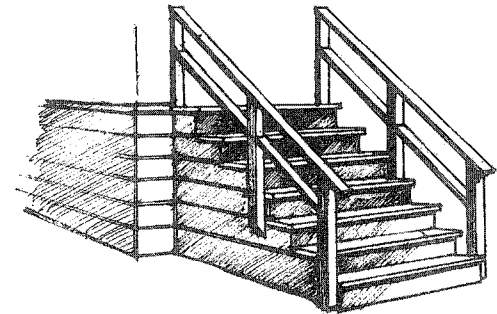

RANCH STYLE RAILING

PROBLEMS: "BACK STAIRS" CHARACTER, INSUBSTANTIAL QUALITY, NO RELATIONSHIP TO HOUSE DESIGN.

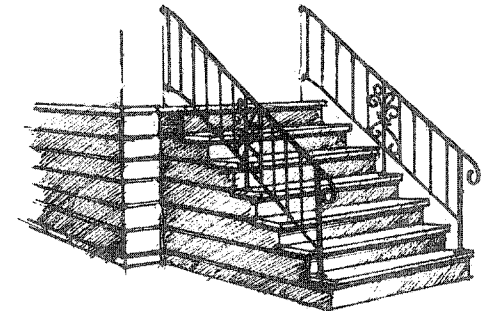

WROUGHT IRON RAILING

PROBLEMS: FLIMSY APPEARANCE. WRONG MATERIAL, INCONGRUOUS CURVED "SPANISH" ORNAMENTS,

PORCH

Every Oakland house style has a front porch. Whether spacious enough for an afternoon nap, or barely big enough to escape from the rain, the porch is the focal point of the facade and deserves the time and effort it takes to repair it properly. It is also a microcosm of the design problems found on the entire building, so **this section is a handy introduction to other repairs you may undertake.**

On any style porch, first **differentiate between ornament and structure.** Then, **determine the extent of damage to each.** If damage is limited, repair the porch; if deterioration is severe, rebuild. Consult Chapter 3, or the City's Inspectional Services Department, for the permit and code requirements.

With the structure and ornamentation both, try to **retain as many of the original pieces as possible.** This saves you the expense of purchasing new materials, spares the house the degradation of a porch which has an inappropriate architectural style, and spares valuable *antiques* from the garbage heap. When the original parts are beyond repair, select new materials that are sympathetic to the design of the house. If exact duplicates of the originals are available and affordable, use them. If not, select counterparts which are the same material as the original, and use a design which is in proportion to the entire building.

Wood Porch

Wood porches belong on houses of the Victorian, Colonial Revival and Craftsman styles. There are so few original wood porches remaining on Oakland's Victorian houses, that it is imperative to save and rehabilitate the survivors. They are an endangered species.

Wood Damage

Wood is very susceptible to decay from moisture. If the wood:

- looks charred, with splits along the grain, or dark veinlike strands
- feels spongy
- shows splits and flaking of the paint

then it has contracted **wet rot.** Wet rot is a fungus that attacks timbers subject to saturation, and it spreads quickly to other wet timbers nearby. If the wood:

- shows thin white strands
- shows wool-like sheets with spreading tendrils
- feels spongy
- has a multitude of tiny open cells

then it has contracted **dry rot.** Dry rot is a microscopic fungus, transmitted by spores which are airborne or carried on shoes or clothing. Under suitable conditions of moisture and warmth, especially standing water, the fungi germinate rapidly on the timbers where they land. The fungi that cause decay are nature's way of breaking down dead wood and returning it to the earth. Unfortunately, the fungi may be trying to recycle the wood frame of your house.

The properties of strength which are reduced by rot are hardness and toughness. **To investigate the extent of the damage:**

- Prod the wood with a sharp tool, (preferably in an inconspicuous location) and observe resistance to marring. If the wood is sound, the prodding will loosen one or two relatively long slivers, and the breaks will be splintery.
- Pry out a sliver of wood with a screwdriver. If toughness has been greatly reduced by decay, the wood breaks squarely across the grain and lifts out easily. If it is still tough, then it splinters and resists removal.

On the porch, **look for symptoms of decay in these places:**

- On the step treads or deck surfaces, especially those that are checked or concavely worn so they trap water.
- At joints in railings.
- At the base of the posts, especially if the posts are not raised above the porch floor.
- On the underside of the deck and framing.

To detect the presence in wood of harmful insects:

- Look at all areas close to the ground for earthen

tubes built over the surface of the foundation as runways from soil to the wood above. Look for swarming of winged adults in the spring and fall, and galleries that follow the grain of the wood. These are all signs of **subterranean termites.** They must return to the ground for moisture, so chemical treatment of the soil is one line of attack.

- Look for sandlike pellets discarded outside the wood, swarming winged insects, and tunnels cut freely across the grain of the wood. These are all signs of **nonsubterranean termites.** The Bay Area is the northernmost limit of their range, and they are rare in Oakland.
- Look near the ground for holes the size of pencil lead and borings the consistency of flour, as an indication of **powderpost beetles.**
- Look for piles of coarse sawdust as evidence of carpenter ants.

Refer to Chapter 3 for information on termite reports and structural pest control companies.

There are three steps to the repair process which will return the porch to a safe state and attractive appearance. These can be simple or quite time-consuming, depending on the design of the porch and the extent of the wood deterioration.

1. **Remove the ornamentation.** Refer to section entitled "Ornamentation."
2. **Repair or rebuild the porch structure.** The structure of a wood porch consists of the posts for support, the joists and decking for the floor, the railings for safety, the columns for support of the porch roof, and the porch roof itself for overhead protection. If signs of decay and infestation indicate that certain structural parts want improvement, refer below.
3. **Repair the ornamentation and install it.** Once the structure is repaired or rebuilt, the ornamentation can be replaced. Refer to the section "Ornamentation."

Posts and Piers

Decayed posts and piers should be rebuilt using a

design which is not susceptible to moisture accumulation. Refer to the section entitled "Foundation: Post and Piers."

Joists and Decking

The tilt of the porch floor is often exaggerated by settlement. To correct this situation, attach the joists to a new spot on the posts for a more level floor area. If the floor boards are worn, but still sound, they can be turned over for re-use. If the decking is the tongue and groove type, it is less likely to have warped over the years because of the secure fit, and if it has not become decayed, it can last for many more years, with good ventilation. Refer to the section "Crawl Space: Vents" for important considerations on air circulation.

Special coating is available to seal the floorboards against the weather. Creosote offers the additional advantage of termite resistance, but its unpaintable, murky brown color is a distinct disadvantage. Cuprenol 20 is a copper green, but it can be painted. The safest selection esthetically is a clear seal that can take paint, like Thompson's, or Seal-Treat.

Columns

Wood columns are used on Victorian and Colonial Revival houses as structural members and as ornamentation on the facade. The columns are classic in style, with a base, shaft and capital. The fluted shaft is hollow, constructed in eight parts like an octagon. The capitals, shaped like a collar to fit around the indented top of the shaft, were made

of exterior plaster, cheap cast iron, or pressed sawdust. Once the seal between capital and shaft is broken, water penetrates the joint and the capital falls off. If the capital is still attached, be sure to keep the seal caulked. If the capital is long lost to deterioration or vandals, it can be replaced with a cast plaster replica. Western Art Stone, in San Francisco, specializes in this.

If the entire column needs replacement, the firm San Francisco Victoriana can accommodate you. A simple, all wood doric column, with base and capital, costs between \$150 and \$200. A more complicated column, with a corinthian capital, would be \$100 more.

The wood columns on a Brown Shingle porch are

PORCH BALUSTRADE RECONSTRUCTION

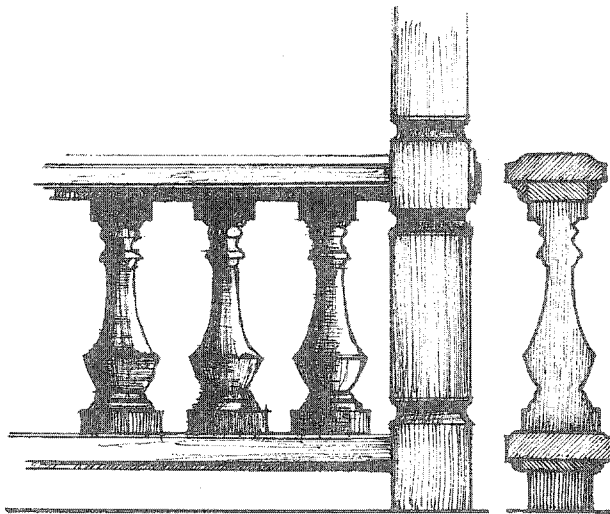

PREFERRED ALTERNATIVE

USES ORIGINAL PARTS INCLUDING MOLDINGS & 3 DIMENSIONAL BALUSTERS AND/OR NEW PARTS DUPLICATING ORIGINALS

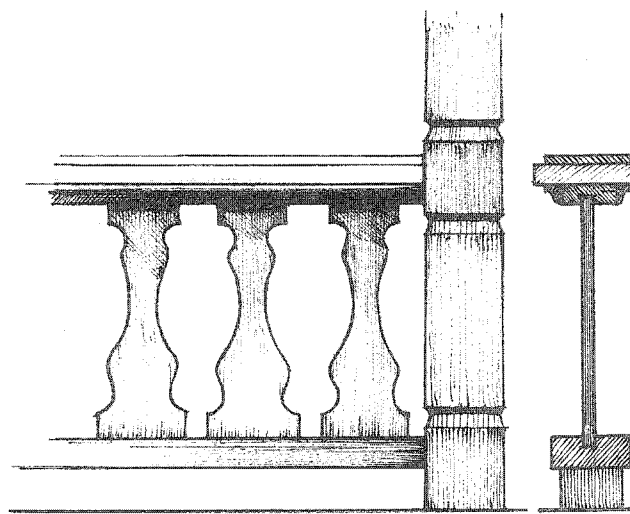

2ND ALTERNATIVE

USES STOCK LUMBER & MOLDINGS TO APPROXIMATE THE ORIGINAL RAILING. TWO DIMENSIONAL CUTOUT BALUSTERS ARE EASIER TO MAKE THAN THE TURNED ORIGINALS.

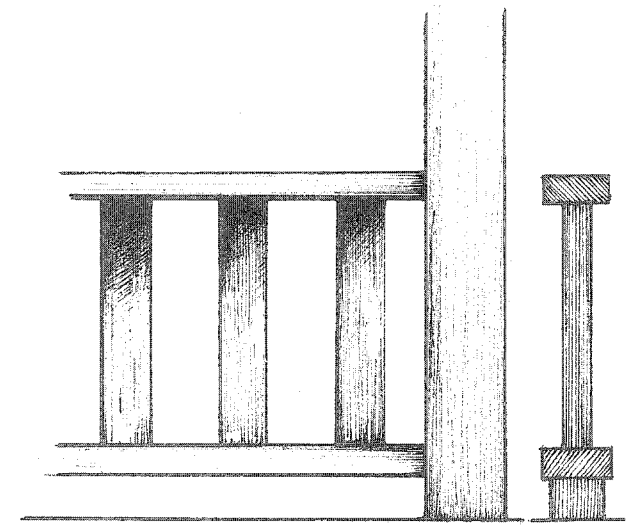

3RD ALTERNATIVE

USES PLAIN LUMBER IN THE SAME PROPORTIONS AND WITH THE SAME SPACING AS THE ORIGINAL RAILING

PORCH RAILINGS TO AVOID

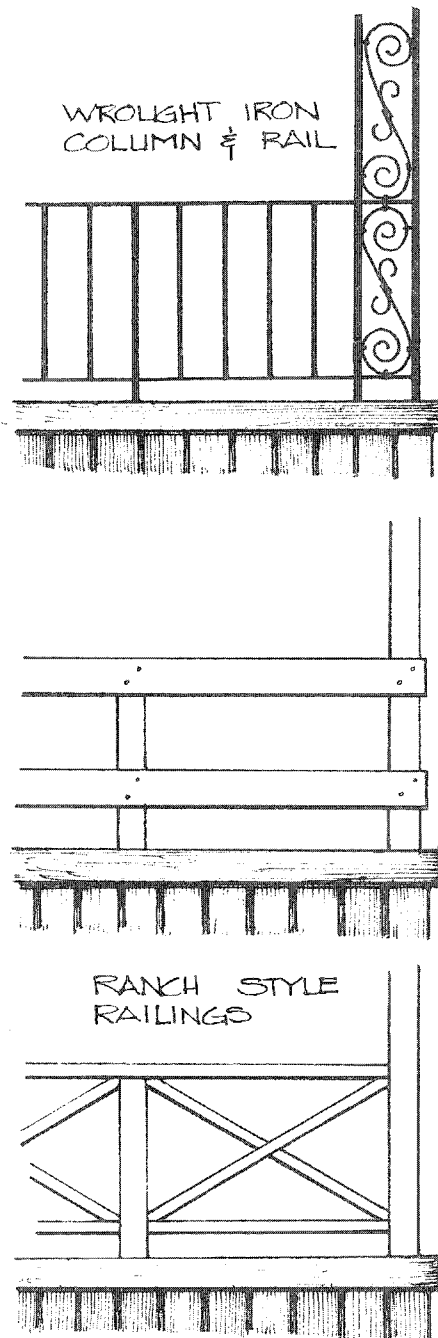

repaired like its porch roof members, and like the posts on a cement porch. Refer to those sections. Be certain to support the porch roof at its proper height while working on porch columns.

The wood porches on some Craftsman Bungalows have stone columns, although sometimes the stone is only a veneer over a wood post. Chemical impurities in the air can cause softer stones to decay, as evidenced by flaking and pitting in the stone's surface. Treat this condition with a chemical preservative available from a brick and stone dealer. If decay has destroyed a stone, it must be chipped out and replaced. Do your best to replace it with a stone that matches the rest of the column. To protect the stones from future chemical erosion, scrub them regularly with plain cold water.

If the mortar binding the stones together is crumbling, restore their strength using the technique described for repointing mortar on brick foundations. Finish the mortar with a concave joint, making sure the stones still project beyond the mortar. Stone columns are important to the architectural character of Craftsman Bungalows and should always be preserved.

Railings

The railing of a porch is structural in that it must support the weight of someone leaning against it, but it is also ornamental because its styling is an important aspect of how the whole house looks. The building code requires that on new porches and balconies which are 2½' or more above grade, the railings must be 42" high and the separation between balusters no more than 9". Most Victorian and Colonial Revival railings are only 24" or 30" high. **According to applicable code, as explained in Chapter 3, the porch railing may be rebuilt exactly as it was designed originally.** However, you may choose to increase the railing height for safety purposes. If the original railing is substantially intact, and its only shortcoming is its height, the best solution is to raise the entire railing on blocks. The second best solution is to add a very simple rail on top of the more elaborate original. In either case, the crossbars of new and old should line up.

Rebuilding a Victorian or Colonial Revival railing

AWNING SUBSTITUTE FOR PORCH

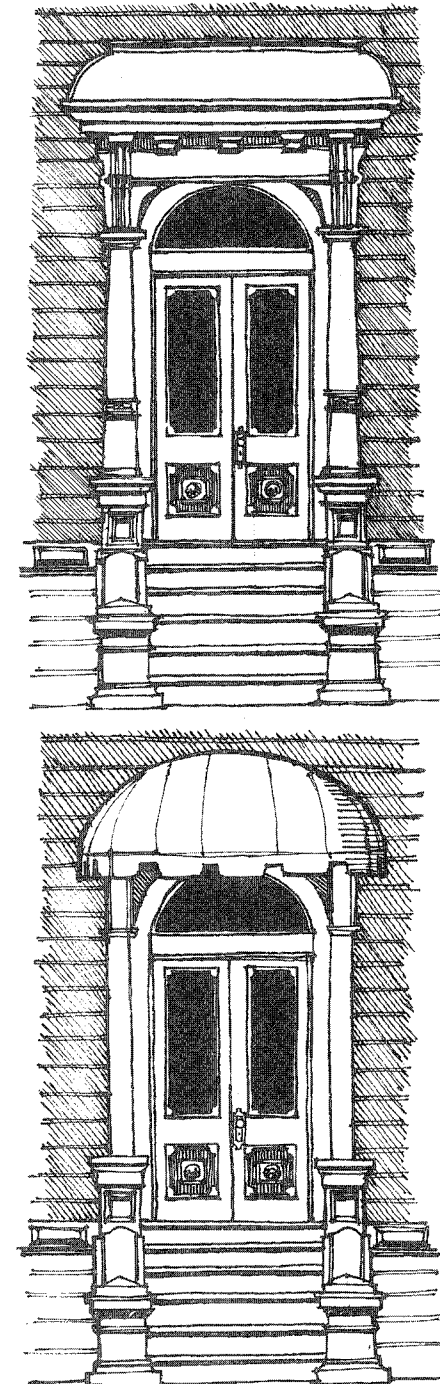

OVERHANG

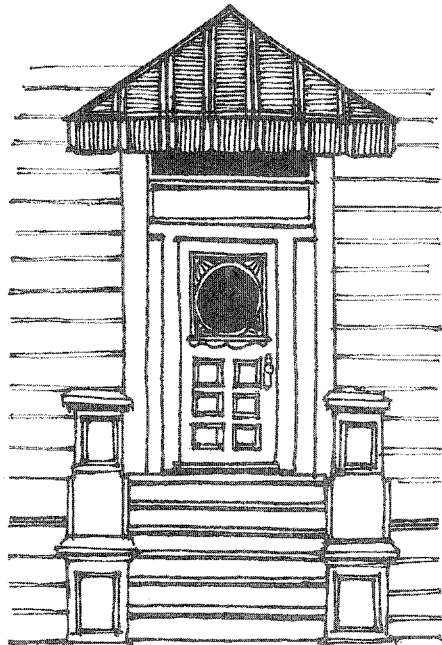
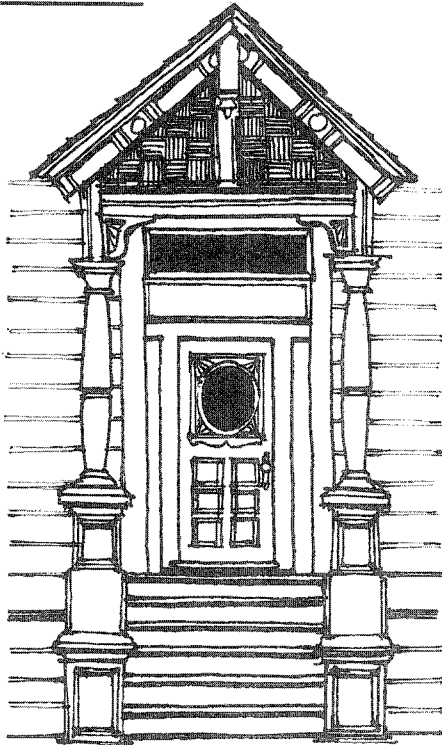

“from scratch” is admirable but painstaking because the turned balusters are costly to reproduce. If salvaged balusters are not available, the most acceptable shortcut is to use cut-out, flat pieces with the same silhouette as the original rounded ones. If even this is too difficult, use conventional rectangular lumber and **retain the proportion and composition of the original railing design.** Whatever you do, avoid the use of wrought iron and horizontal ranch style railings.

The cap of the original railing was as shapely as the balusters. Recreate this three-dimensional effect with stock lumber and molding, as illustrated in the earlier section on wood stairs.

Roof

On the typical Victorian and Colonial Revival porch, the roof is flat, and prone to collecting water. Proper flashing between porch roof and building wall is a necessity to prevent decay in the joints. Refer to the section entitled “Roof: Flashing” for more information.

A good temporary solution to rebuilding the porch roof on a Victorian is to install a fabric awning over the front door. Select an awning design whose shape and size is reminiscent of the original overhang. Use fabric, not metal or fiberglass, because cloth has a soft texture which sympathizes with the wood building; a harder metal or synthetic product contradicts it. Besides, this is a temporary solution, so it need not last indefinitely. In fact, avoid building a more permanent compromise, or there will be little incentive to go back and rehab it properly when the time comes.

The roof of the Brown Shingle style porch is actually a trellis. It provides an intriguing shadow pattern on the porch floor instead of continuous shelter overhead. Vines are often trained on the porch and these may be a contributing factor to wood damage, if the lumber was not properly treated with a preservative first.

The individual wood members are typically cut to more generous dimensions than standard lumber today. To **get the right size replacement**, ask the lumber yard for rough-finish wood to the size you

STICKWORK REPAIR

REMOVE THE ROTTED END, CUTTING ALONG LINES A, B AND C SUCCESSIVELY. ZIG-ZAG CUT HAS MORE BONDING AREA, MAKES A STRONGER JOINT.

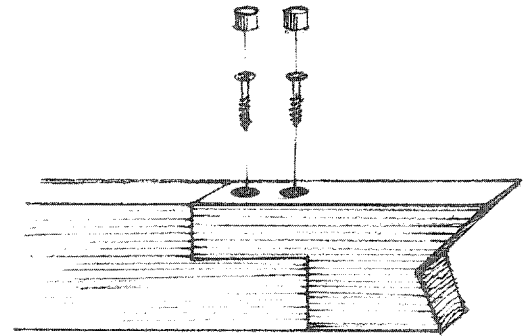
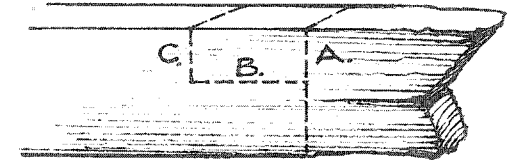

CUT A NEW END FROM EQUAL SIZE LUMBER USING THE ORIGINAL AS A GUIDE. DRILL PILOT HOLES THROUGH NEW WOOD TO OLD WOOD. DRILL COUNTERSINK HOLES HALF A SCREW LENGTH FROM OLD WOOD. APPLY WOOD GLUE TO JOINT, SCREW TOGETHER PIECES. CAP HOLES WITH GLUED DOWEL SECTIONS.

desire. Although the wood you get is larger than its standard-finish counterpart, the price of the rough-finish wood is lower. For example, rough finish redwood, 4" x 4" construction heart, costs 92¢ per board foot. A standard-finish 4" x 4", also construction heart, is 94¢ to \$1.09 per board foot and its dimensions are really 3½" x 3½".

If only the end of a wood member is damaged, replacement of the entire length is unnecessary. Detach the member in question from the structure for ease in handling, providing temporary support where necessary. Remove the rotted end, plus a few inches for good measure, and splice on the new segment, as illustrated. The holes drilled for the screws will be so deep that they must be refilled with wooden plugs instead of ordinary wood putty. When the bond is secure, treat both segments with a wood preservative. Let it dry, and replace the member in the stickwork porch. Although this technique is more time consuming, the savings may make it worthwhile.

Stucco Porch

The stucco porch is found on stucco style houses, namely California Bungalow, Prairie School and Period Revival. It is also found on houses which initially had a wood porch but have since been modernized. If your stucco porch is in need of repair, and stucco was not the original building material, consider replacing the porch with one better suited to the architecture. In most cases the more authentic choice is wood.

Stucco is a many layered affair. The structural wood frame is covered by rough sheathing, the sheathing is covered by tar paper, the tar paper by wire or wood lath, and the lath by three coats of a stucco mixture which is primarily Portland cement and sand. Any or all of these layers may need repair.

Repairing small cracks or holes in the stucco surface is not a difficult operation, but definitely a time-consuming one. Therefore, it behooves the homeowner to repair the cracks him- or herself, because paying for a professional's time makes this a needlessly expensive operation. (Refer to the section

ELEPHANTINE COLUMN REPAIR

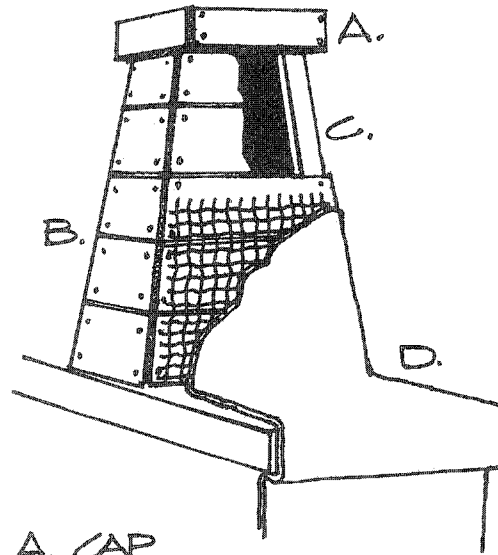

- A. CAP
- B. BOARD SHEATHING
- C. 2x4 (CORNER OF FRAMEWORK)
- D. STUCCO

REPAIR

- INTERLOCKING 'S' SHAPED WIRE COMMONLY REPLACES BOARD SHEATHING & WIRE NETTING
- MOUND STUCCO SLIGHTLY TOWARDS MIDDLE OF CAP TO FACILITATE DRAINAGE.

"Sheathing: Stucco" for more complete instructions.) It is important to **keep cracks patched**, or they will enlarge and allow moisture to seep into the structure underneath.

On stucco porches, the **underlying wood frame is subject to decay from water accumulation and poor air circulation, and to damage from insect infestation.** A deteriorated porch structure is a very common item in the Termite Report prepared prior to sale of a house, but it is difficult to recognize from the outside. The causes of damage are actually the best symptoms to go by. Check for large cracks in the stucco, faulty gutters, inadequate flashing, and leaks in the four corners of the flat tar and gravel roof. If damage is severe, the entire porch must be rebuilt and re-stuccoed, with the help of a contractor.

The most important design consideration in the stucco porch of a California Bungalow is the pair of elephantine columns which flank the front steps. The wood members which establish the shape of these heavy set, often tapered posts, are subject to decay due to poor ventilation.

To correct this unsafe condition, the structural stability of the columns must be reinstated. To maintain the proper appearance of the stucco bungalow, **the elephantine columns should always be replaced in kind.** Never substitute wrought iron posts, or a piece of lumber, or a steel pipe. These substitutions do not express the weight of the roof above. Their spindly silhouette looks skimpy in comparison to the chunky appearance of the rest of the house. The bungalow has a broad and substantial appearance, it sits solidly on the ground. The elephantine porch columns are in proportion to the rest of the building, and essential to its architectural image. Besides, the substitution may not be sturdy enough to meet code.

Another problem on stucco porches is rot in the **joints between the porch floor and the frame wall of the house due to improper or omitted flashing.** Flashing is a curved strip of building paper and metal which should be installed at this junction to direct the rain water which runs down the wall away from the joint. If there is no flashing, water collects in the joint and deteriorates the stucco above it and

ELEPHANTINE COLUMNS: DO'S AND DON'T'S

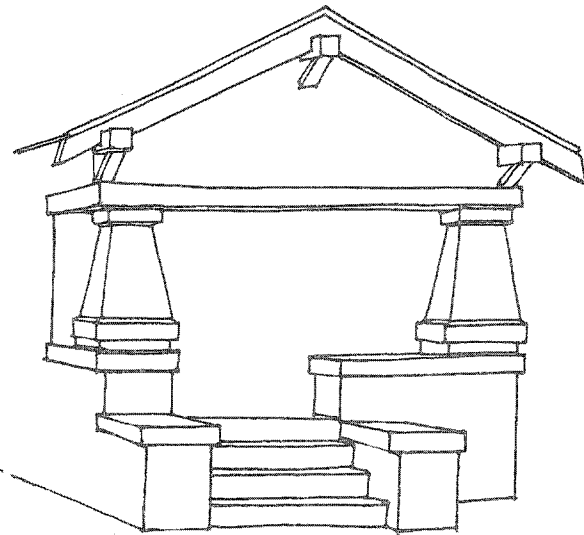

ORIGINAL ELEPHANTINE
COLUMNS

SUBSTANTIAL AND SOLID-LOOKING
LIKE THE HOUSE ITSELF

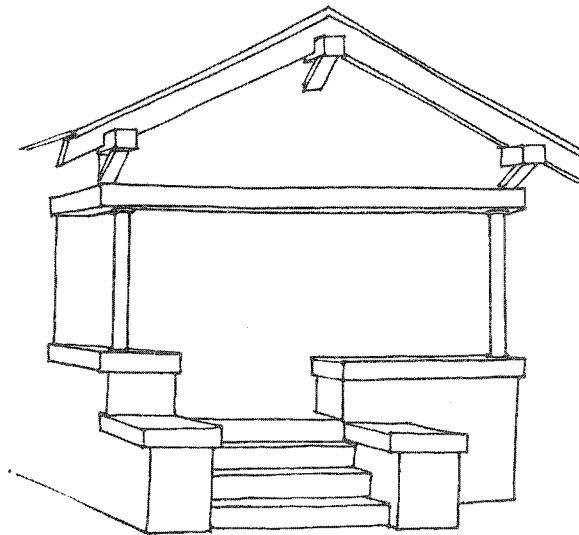

STEEL PIPE COLUMNS

ALTHOUGH STRUCTURALLY ADEQUATE,
THEY DON'T LOOK STURDY ENOUGH TO
HOLD UP THE PORCH ROOF

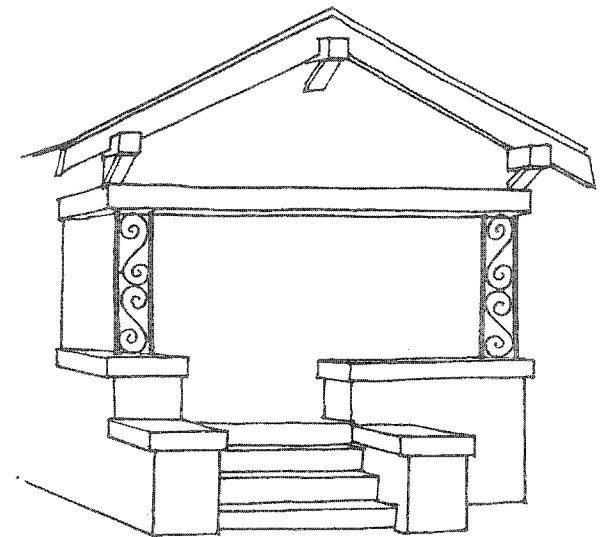

WROUGHT IRON STYLE COLUMNS

CURVY AND LACY IN TEXTURE,
THEY ARE VERY OUT-OF-PLACE ON A
BUNGALOW PORCH. ALSO, THEY MAY
NOT BE STRUCTURALLY SOUND.

the cement-covered wood decking below. Correcting this situation requires removing the damaged materials prior to installing the protective metal strip.

Flashing is equally important at the joint between the porch roof and the wall of the house. If water is allowed to accumulate here, it can penetrate to the wood frame and cause serious structural damage. (Refer to the section "Roof: Flashing.")

A final problem with stucco porches is more one of function than maintenance. Many homeowners, seeking extra living space, choose to enclose the front porch. Rarely does this accomplish anything, as the effort creates nothing more than a very small and very drafty room. To boot, a gracious entryway, and a place for the front door to swing open without jarring the visitor on the front steps, are lost

in the bargain. **If your porch is still a porch, do not enclose it.**

If you absolutely need a windbreak or a sunscreen to make the porch more comfortable for sitting or for growing plants, use a plain transparent plastic or glass panel. This will accomplish your goal without disrupting the rhythm of California Bungalow columns which make such an attractive street scene.

Cement Porch

The original porch on Wartime Tract houses is a cement slab floor, as are modernized porches on almost every other style. The cement may suffer from small cracks. The technique for repairing these is described in the section on concrete stairs. Major

breaks in the cement are a symptom of a settlement problem, and a professional contractor or engineer should assess the situation.

Make sure that the porch slab is not draining toward the house. Test this by placing a child's ball on the cement and seeing which way it rolls. If the ball rolls toward the house, then water is being directed toward the building too. If you notice signs of decay where the wood siding meets the porch floor, then ask a contractor about correcting the slope of the slab.

On the tract house the porch roof is a continuous overhang from the main roof, so problems with flashing encountered in styles where the porch roof is a separate plane are not a worry here. However, the wood posts which support the overhang are

CEMENT PORCH FLOOR REPAIR WITH FLASHING

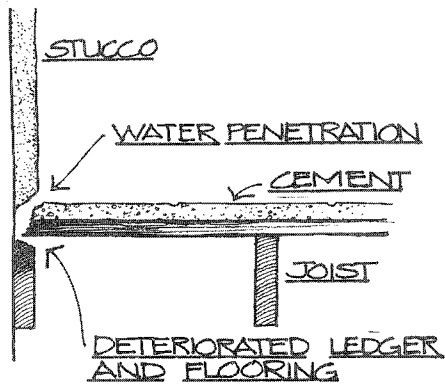

A. CHIP BACK STUCCO ENOUGH TO INSTALL FLASHING. (UNDERCUT FOR BETTER BOND WITH NEW STUCCO.)

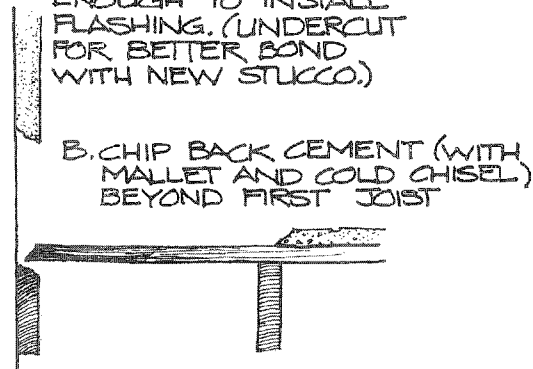

C. REPLACE ROTTED WOOD; IN THIS CASE, THE LEDGER BOARD NEXT TO THE HOUSE AND THE FLOORING BACK TO THE FIRST JOIST. POUR NEW CEMENT. WHEN DRY, INSTALL FLASHING AND NEW STUCCO.

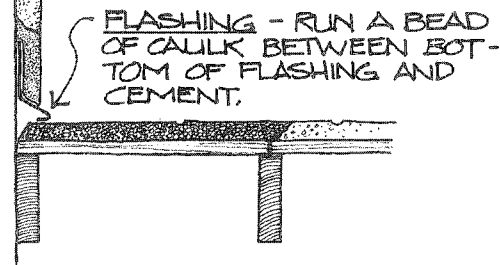

subject to decay at the bottom if water is allowed to accumulate between the post and the cement slab. Refer to the section on wood porches for the telltale signs of rot. If the base of the post has decayed, it is easier to remove the post to work on it, providing a temporary support for the roof in the meantime.

It is usually unnecessary to replace the entire wood post. Instead, remove the decayed section, plus 4" leeway, and graft on a new weather-treated piece of the same dimension by the mortice and tenon, or the lap technique. Seal the joint between the new and the old sections with wood putty prior to painting it. To prevent recurrence of decay at the base, use a better method of securing the post to the concrete which allows air to circulate, as illustrated in the section "Foundation: Post and Piers."

Do not replace the wood post with a wrought-iron one. Its garish curlicues look wrong with the frank lines and geometric form of the Wartime Tract house. When repairing the wood post, be sure to retain the short diagonal braces at the top. If your porch posts do not have these v-shaped braces, and you would like some additional ornamentation, add these authentic features rather than anything wrought-iron or pre-fabricated.

FRONT DOOR

The front door does many jobs. Visually, it catches the eye. Functionally, it protects against unwanted intruders. Symbolically it says, "You're home!" On pre-war houses in Oakland, the importance of the front door was recognized by the care given to its design. The front door was always a panel door, constructed of top quality materials and styled to match the architecture of the house.

Expensive Victorian homes had a pair of centrally opening golden oak doors, with a panel of beveled or flashed glass on top and recessed molding or a veneer of grained mahogany below. More common Victorians and Colonial Revival houses had a single, broad oak door with a large window on the

upper portion and decorative molding below. The front door on the Brown Shingle, the Craftsman Bungalow, and the California Bungalow was made of fir, redwood, or oak, consistent with the material selected for the interior woodwork. The window was either leaded, made of small panes of beveled glass, or eliminated altogether. The Prairie School house has an oak door stained to match the finish of the hardwood inside. The fancier Period Revival houses had front doors stained and textured to make them look more rustic. Flip through the illustrations in Chapter 2 for some typical examples.

Unfortunately, these valuable doors are often disposed of in the course of home improvement, even though most of the problems can be corrected with a little patient energy. **Substituting a modern, flush door for a beautifully panelled original is a shameful waste of an architectural resource as well as a careless waste of money for the replacement.** The problems with old doors fall into four categories: fit, wear, hardware, and security. The subject of fit, more pertinent to interior doors, is discussed in that section.

Wear

The front door gets a lot of use and abuse, from people and the weather both, so some damage is inevitable.

Panels

Oakland houses that pre-date World War II originally had panelled front doors. The shape and number of panels per door varies, but the construction technique is the same: slender panels are enclosed in a heavy structural framework and secured in place by moldings for a solid, three-dimensional design. The lower panels, made of wood, usually stay intact, but the upper panels, made of glass, are much more fragile. The glass may be rectangular, round, or oval; it may be a large single window, a matching pair, or a composition of small square panes; and, it may be etched, leaded, stained, or flashed. **If the glass is chipped, cracked, or missing altogether, repair or replace it with glass.** The entry hall depends on the light this window affords. (Refer to "Windows" for more information.)

HOW TO REPLACE DOOR GLASS

FRY MOLDING OUT FROM GLASS PANEL. DO THIS CAREFULLY WITH A BROAD, STIFF PUTTY KNIFE SO MOLDING CAN BE RE-USED.

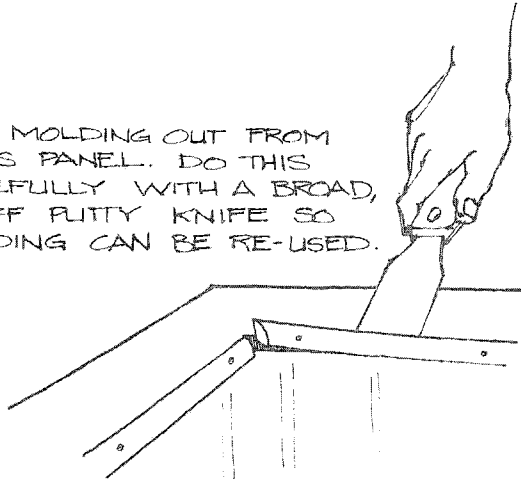

GENTLY REMOVE GLASS. CLEAN BED & APPLY A THIN STRIP OF GLAZING COMPOUND IN THE BOTTOM OF THE BED.

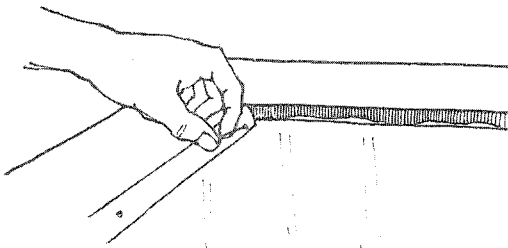

PLACE DOUBLE-STRENGTH PANE CUT SAME SIZE AS ORIGINAL (OR $\frac{1}{8}$ " SMALLER THAN OPENING IN HEIGHT & WIDTH) IN BED, PRESSING TO FORCE COMPOUND UP AROUND EDGES. APPLY 2ND LAYER OF COMPOUND AROUND GLASS EDGE. RE-NAIL MOLDING. FILL NAIL HOLES.

Veneer

The framework of the door, the portion which surrounds the panel, is typically a solid piece of softwood with a thin veneer of oak, walnut, or mahogany on either side. When moisture seeps in between the softwood and the veneer, they separate, and the veneer begins to fray at the lower edge.

To repair this condition without it looking like a patch job, make the repair all the way across the bottom of the door. Cut off the ragged piece back to sound wood, using a back saw or an electric router with a straight blade set at a shallow depth. Glue a new piece of veneer of the right size, color, and texture into place, and clamp down until the glue sets.

If only a small corner of the veneer is damaged, it can be chipped back with a chisel. Fill it in with a wood putty of matching tone. Repairs are simpler if the door is already painted since touch-up paint can mask corrections which are hard to conceal with the natural wood finish.

To ward off future damage from scuffing, a kick plate can be installed quite simply with a drill and screws. Try salvage yards for interesting brass plates that match the other, original features on the door. Otherwise, use a very plain piece of non-ferrous metal or heavy-duty plastic. Do not use aluminum—it is too bright and scratches too easily. Copper and brass are a good choice because they acquire a patina or can be shined. The plate should be 2" narrower than the door width to allow for door stops.

Paint

A natural wood door is preferable to a painted door because its textured grain lends richness to the appearance of the house. If the door is in decent condition, and is as yet unpainted, perpetuate the natural finish. If it is severely weathered, however, or if the repairs have left ghastly scars, painting is a much better solution than buying a new door. If you choose to paint the front door, make sure the surface is treated first with a wood sealer. Otherwise, the paint will be sucked up, and even three or four coats won't achieve a finished

HOW TO REPLACE A DOOR THRESHOLD

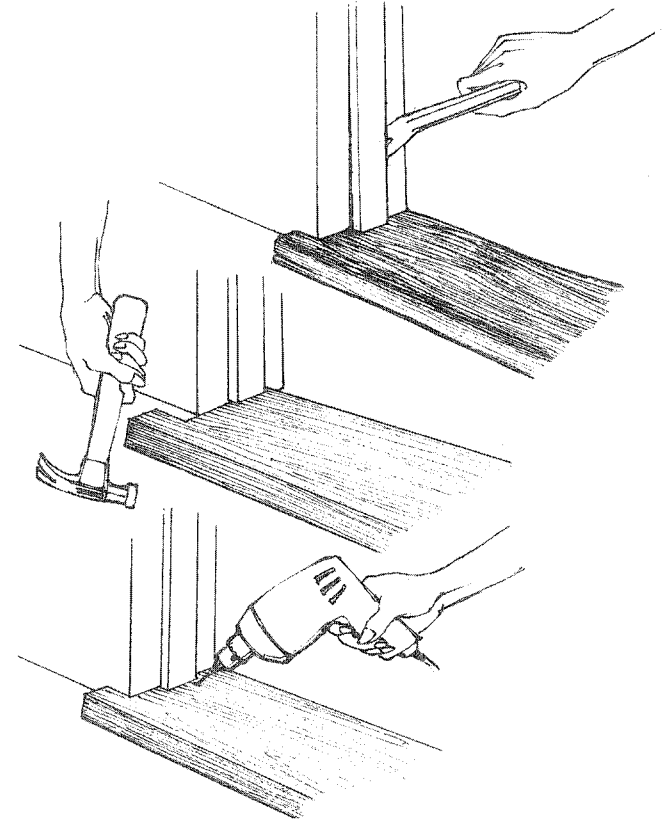

SWING DOOR WIDE OPEN. IF IT DOESN'T CLEAR THRESHOLD, PULL HINGE PINS AND REMOVE DOOR. USING A PRY BAR, START PULLING DOORSTOP $\frac{1}{2}$ " AWAY FROM DOOR-JAMB, FROM BOTTOM TO TOP. THEN REMOVE STOP COMPLETELY.

TRY TO PRY UP THRESHOLD INTACT FOR USE AS A PATTERN. IF NECESSARY, SPLIT IT INTO PIECES WITH A WOOD CHISEL. TRACE OUTLINE OF THRESHOLD ON BOARD OF EQUAL THICKNESS (OR TAKE CAREFUL MEASUREMENTS FIRST IF YOU MUST SPLIT THE OLD ONE). TRIM NEW THRESHOLD TO SIZE, THEN TAP LIGHTLY INTO PLACE.

FOR HARDWOOD THRESHOLDS (THE BEST CHOICE FOR WEAR), DRILL PILOT HOLES A BIT SMALLER IN DIAMETER THAN NAILS TO AVOID SPLITTING WOOD. COUNTERSINK NAILS (OR SCREWS), FILL HOLES WITH PUTTY.

look. The seal also provides protection against moisture penetration in the future. (Refer to the section "Facade: Paint.")

If the door has already been painted and you want to reverse the process, arrangements can be made, with Keystone Strippers for example, to have the door dipped in stripping solvent. This cleans off most of the paint, although the detailed work must still be done by hand. An unduly long bath in the stripping vat risks damage to the wood structure and may make the surface porous and rough so don't insist on removing every shred of paint by prolonged immersion. Dipping costs between \$15 and \$20. A call in advance can confirm one-day service. After stripping, treat the wood with varnish or oil. (Refer to Chapter 5, "Walls: Wood" for more information on stripping.)

Ornamentation

Original Victorian doors have decorative wood pieces applied over the lower panels in a design which matches the ornamentation elsewhere on the building. **Preserve this ornamentation** if it still exists, or try to recreate it if it has been lost to vandals or decay.

Threshold

A worn threshold gives the entryway an unnecessarily shabby appearance, and may present a tripping hazard. It should be replaced in-kind, as illustrated.

Hardware

The doorknobs and hinges on the front door are usually made of brass, steel, or brass-plated steel. Whether elaborately detailed or plain, the brass takes on an elegant lustre when maintained. **Preserving the original hardware on the front door is an example of how important attention to detail is for a satisfactory end product.**

Most older exterior doors are hung on heavy-duty, butt type hinges made of two leaves, screwed to the door and jamb respectively, and held together by a pin. Often, the weight of the front door enlarges the holes which once held the screws snugly.

This results in a stubborn door that sticks on one side.

To tighten the hinge attachment, you can try longer screws. Or, you can refill the holes with either putty, plastic wood, a dowel or wooden match sticks, and reset the screws. Before you do this, remove the door by knocking out the hinge pin with a nail set and hammer while the door is closed. Then remove the hinges.

If the hinges are covered with paint, let them soak in a coffee can of paint remover to return the brass to its distinctive natural finish. Otherwise, scour the oxidation with Brasso, or another tarnish remover, following the directions on the label. To highlight the detail, polish the brass every few months thereafter. Subsequent polishing can be postponed several years by coating the hinge with a clear lacquer following the clean-up operation. Acrylic spray in an aerosol can, like Krylon, is easy to apply. The same general rules apply to the brass mail slot, if there is one.

Original doorknobs are a luxurious experience to hold and behold. They should be retained for use as a handle, even if their lock mechanisms are no longer adequate for security. Keep the faceplate tarnish-free with a brass cleaner. If the brass plating on the knob has worn off in spots, it can be replated. Meanwhile, the brass cleaner will keep the rust off the exposed steel too.

If the latch bolt is unresponsive, it should be fixed for the convenience of a door that closes properly, rather than for security. Sometimes the latch bolt and the strike plate don't meet because the door itself does not fit properly. To determine if fit is the problem, see if the hinge screws are loose, as described above, and conduct the experiment outlined in Chapter 5 under "Doors." If it turns out to be the latch mechanism, you can detach it from the door and bring it to a locksmith for repair. Of course, do this only after you've installed the auxiliary deadbolt.

Security

Security in the home is a topic on everyone's mind these days, and sometimes the solutions are at odds

with a building's architectural style. The recommendations that follow demonstrate that a house can be made secure without sacrificing the quality of its appearance.

Remember that the matter of home security extends beyond the front door. It includes all other openings into the house, the visibility of the house from the street, the presence of street and yard lights, blind spots behind walls, and even the number of neighbors' eyes casually looking out their windows. In fact, according to the Crime Analysis Division of the Oakland Police Department, only 15% of residential break-ins are through the front door. So, **by directing your security concerns to the back door, windows and lighting as well, you need not sacrifice a beautiful front door pointlessly.**

The first consideration is the vulnerability of the door itself. There is no debating the fact that modern, flush, solid-core doors are harder to break down than the original panel style. However, the modern ones are so inferior esthetically, and there are so many aspects to security other than the solidity of the front door, that retention of the original panel door is highly recommended. In fact, the back door is so much more susceptible to break-ins because of its flimsy construction and hidden location, that the homeowner is well-advised to leave an attractive front door intact, and concentrate on the back door.

There are a few steps to take which can make an original, panelled door, front or back, very difficult to break through, improvements which **increase security without obliterating the original design:**

- The easiest option is to rely on a twin-cylinder deadbolt with a 1" throw which cannot be unlocked from the inside without a key even if the glass is broken and the intruder reaches in to open the door. A vertical deadbolt costs \$9.85.
- Reinforce the wood panels, by installing plain metal bars on the outside. Paint the bars so they blend with the color of the door. Or, add a piece of plywood on the inside of the door behind the panels, and stain or paint it to match the door.
- Reinforce the glass by adding a panel of break-

resistant plastic, like Lexan MR 4000, in front, as seen at the Camron-Stanford house. A 2' x 3' piece of virtually bullet proof Lexan 3/16" thick costs about \$30. A 2' x 3' piece of bullet-proof plexiglass costs about \$15. Both are available at B-B Plastics in Berkeley. Or, leave the glass as is, and shield it with a woven metal screen of #10 wire on a 1 1/2" grid. A 2' x 3' piece costs \$42, and is available at Oakland Wire and Iron Works.

DOOR SECURITY: REINFORCED DOOR FRAME

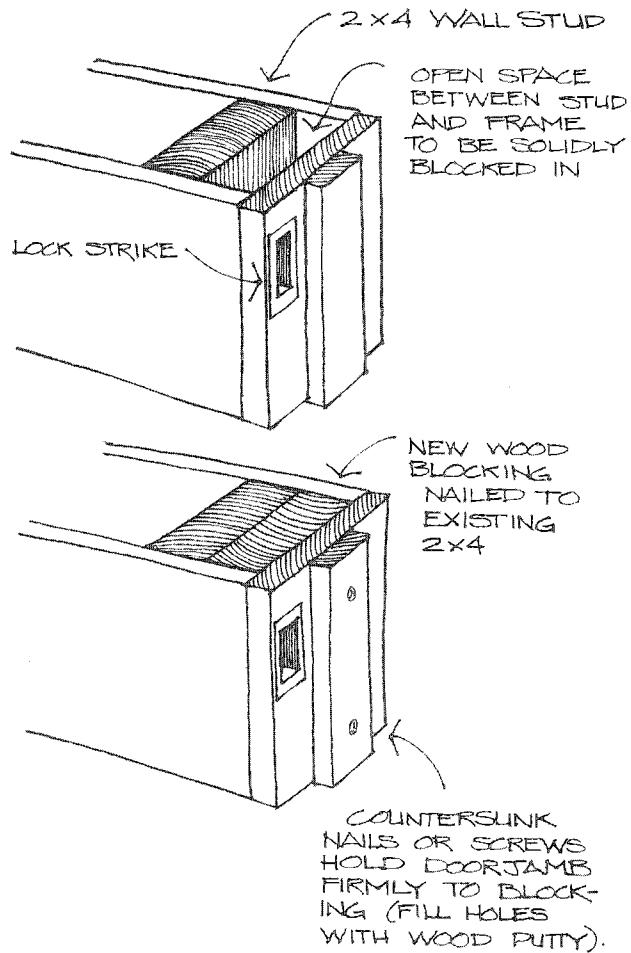

If a new door is a must, there are secure and attractive options other than the conventional, flush solid-core type which looks wrong on every one of Oakland's architectural styles discussed in **REHAB RIGHT**. Made of particle board, the standard 3' x 6'8" flush door sells for \$35 with a mahogany veneer, or \$44 with a birch veneer. For as little as \$20 more, you can get an honest, full-

DOOR SECURITY: BRACED STUDS

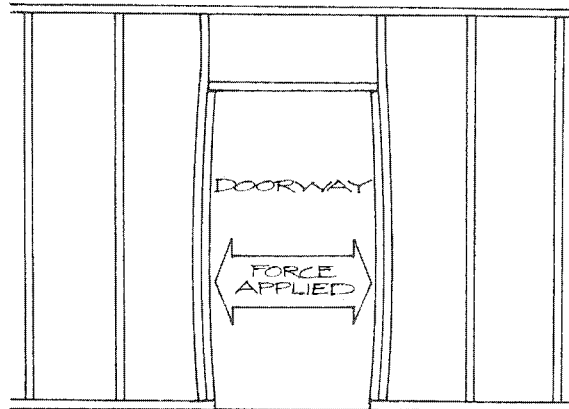

A. STUDS IN DOORFRAME ARE VULNERABLE TO SIDWAYS PRESSURE.

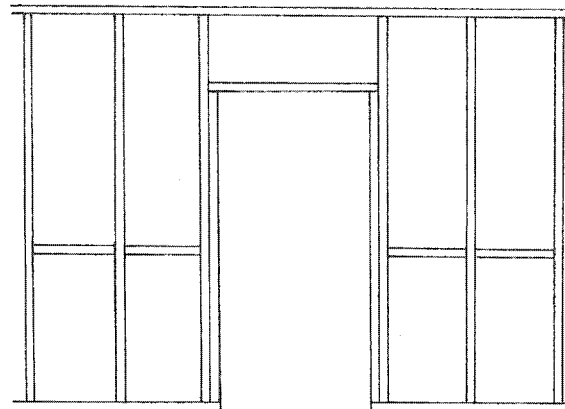

B. ADDING 2x4 BLOCKING BETWEEN STUDS AT THE LOCK LEVEL REINFORCES DOORFRAME.

sized panelled door at a salvage yard. At Sunrise Salvage, in Berkeley, panelled doors cost between \$65 and \$150. Prepare for a trip to the salvage yard by measuring the dimension of the doorway from jamb to jamb, its height and its width.

New old doors, that is, new doors that are built in the panel manner, are available at Truitt and White lumber yard. Ask to see the catalog to find a design suitable to the house, but make sure the panel portion is at least 1/2" thick for security purposes. A pa-

DOOR SECURITY: NON-REMOVABLE HINGE PIN

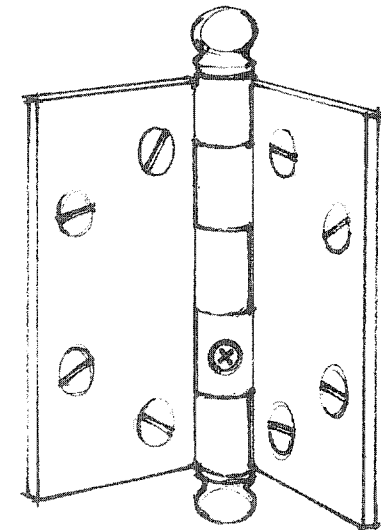

OPEN DOOR. FROM INSIDE OF HINGE, DRILL A PILOT HOLE INTO HINGE PIN. COUNTER-SINK HOLE SO SCREW HEAD WON'T INTERFERE WITH CLOSING OF DOOR. INSERT SELF-TAPPING SCREW.

nelled door made of clear white pine costs about \$85. With a window, the price is about \$126.

Whatever door you choose, make sure that it is the correct size for the door frame. Victorian door frames are often taller than conventional modern doors, forcing the homeowner to make a dreadful assault on the appearance of the house by blocking in the leftover space. Do everything you can to avoid this mistake.

No matter how secure the door and lock may be, if the door frame is vulnerable, forced entry is fairly easy. Many door frames are set into the wall without solid connection to the studs. Since the lock

FRONT DOOR: DO'S AND DON'T'S

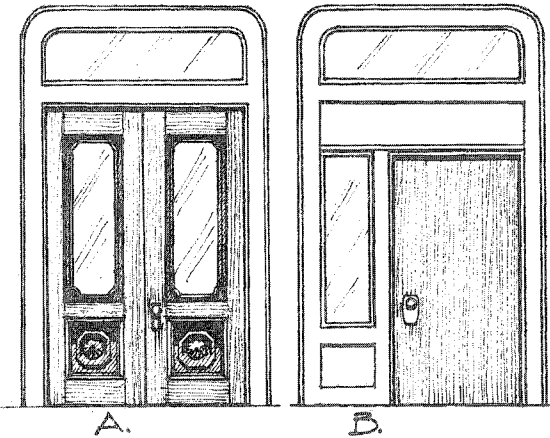

- A. ITALIANATE DOUBLE DOORS LIKE THE HOUSE STYLE, THEY ARE VERTICAL IN EMPHASIS AND RICHLY 3-DIMENSIONAL. ORIGINAL DOORS WORK WITH YOUR HOUSE'S ARCHITECTURE. IF YOU HAVE THEM, KEEP THEM, IF THEY NEED WORK, FIX THEM AND IF THEY HAVE BEEN REPLACED, IT'S WORTH THE EFFORT TO FIND NEW OR SALVAGED REPLACEMENTS SUITABLE FOR YOUR HOUSE STYLE.
- B. BLOCKED-DOWN REPLACEMENT SUFFERS FROM ASYMMETRY, SQUATTY PROPORTIONS AND LACK OF VISUAL TEXTURE. AVOID THIS ALL-TOO-COMMON REHAB ERROR.

DOOR SECURITY: PRECAUTION FOR EXTERIOR HINGE PIN

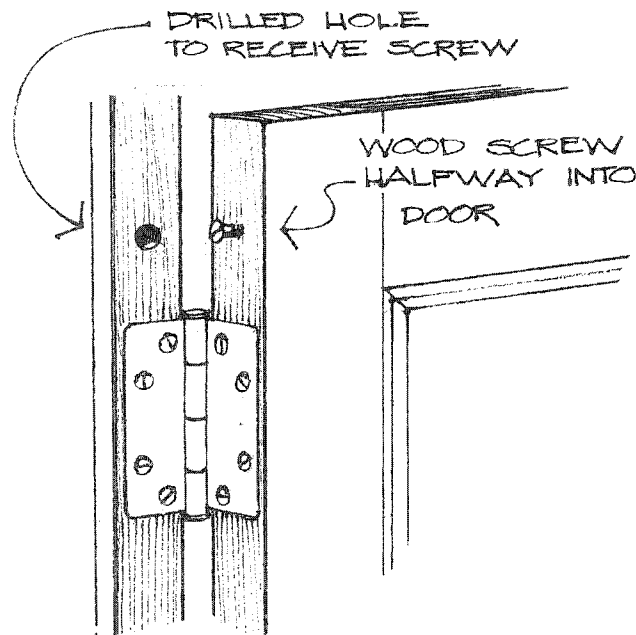

slides into the frame, the frame, usually a $\frac{3}{4}$ " thick piece of wood, is all that is holding the door shut. A solid kick to the frame at the lock will rip the bolt out of the frame or the frame out of the wall. Remedy this situation by adding a solid blocking member equal to the height of the door between the door frame and stud. Nail them solidly together.

The frame is also vulnerable to sidewise pressure. Add 2" x 4" solid blocking between the studs at lock level, for a much stronger frame.

The hinges should be mounted on the inside of the door. If they are already on the outside, they should have a non-removable pin. If the hinges are modern ones, they can be replaced with a special type of hinge that comes with a non-removable pin. If the hinges are original, do not sacrifice the brass and beauty in the name of security. The pin can be made non-removable by drilling a hole through the hinge pin from the inside and inserting a machine screw.

Another precaution is to install a wood screw half-

way into the door near each hinge. Drill a hole into the jamb opposite each screw to receive the projecting screw heads. Then, the door will stay in place even if the hinges are removed.

Old doors have mortise locks which are ineffective for today's security needs because their bolt does not have enough throw. The minimum acceptable throw is 1". However, this is no reason to discard the original brass knob and faceplate. Retain them as an ornamental handle, and supplement them with a twin-cylinder rim lock that has a vertical deadbolt. This type of lock requires a key from inside and out, so even if someone breaks the glass and reaches in, they cannot open the door. Be sure to keep a spare key on a hook nearby to use for emergency exits.

The glass panel in the door is extremely valuable for the light it introduces to an otherwise dark hallway. However, it is inadvisable to let people look into the house. A translucent curtain or shade,

DOOR SECURITY: ONE ARCHITECT'S SOLUTION

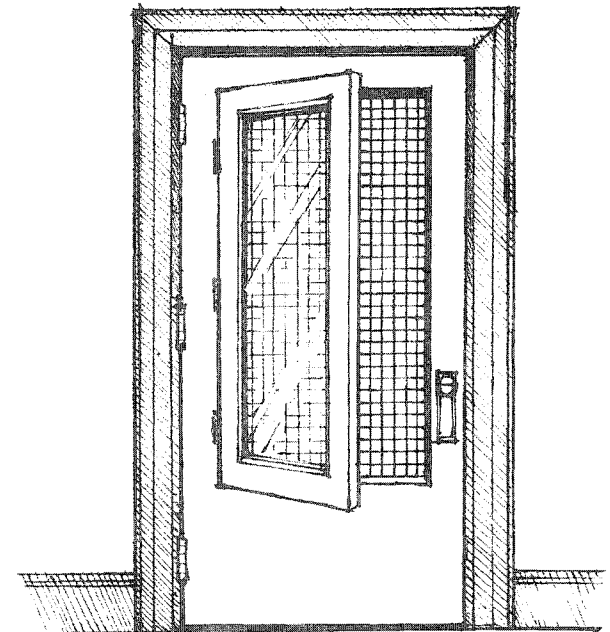

sandblasting the glass, or frosting it with a spray can, are all acceptable solutions. An ingenious idea, developed by Oakland architect John Campbell and shown here, solves the problem of security, and still allows for light, air and controlled visibility.

Some Victorian houses have double doors opening in the center. These have the special problem of a weak point where they meet. To secure these doors, use the vertical rod-type lock that effectively attaches the door to the floor and the ceiling when operated.

It is a good idea to have a light at the front door, and to keep it on when it's dark. When selecting, avoid the commercial fixtures which try to look "olde." If you can, find a genuine globe from the proper period at a salvage yard, or even a thrift-shop. If you must get a new light fixture, select a style that is as plain as possible, one that does not compete with the legitimate features of the house and its architectural style.

Garage Door

While Oakland's earlier house styles were built before the automobile era, many property owners have taken advantage of the raised first floor typical to Oakland cottages and rowhouses, to incorporate a garage into the house structure. To keep the garage door from having a jarring visual impact on the facade, select as simple a design as possible. Cover it with the same material in the same pattern as the siding on the rest of the house. This applies to detached garages too.

Windows are unnecessary, unless the garage doubles as a workshop. In that case, small square panes are far preferable to long horizontal windows, or whimsical curved ones. Refer to the drawings in Chapter 2 of the San Francisco Stick style and the Queen Anne Cottage for good examples of garages that were added well after the house was built, but which maintain its architectural character.

The walls of the garage must be designed for fire resistance. This is a requirement of the *Oakland Housing Code*, imperative for the safety of the residents, and literally essential to the preservation of the architecture. Many garages, converted without

DOOR SECURITY: ORIGINAL DOOR KNOB AS HANDLE WITH AUXILIARY LOCK

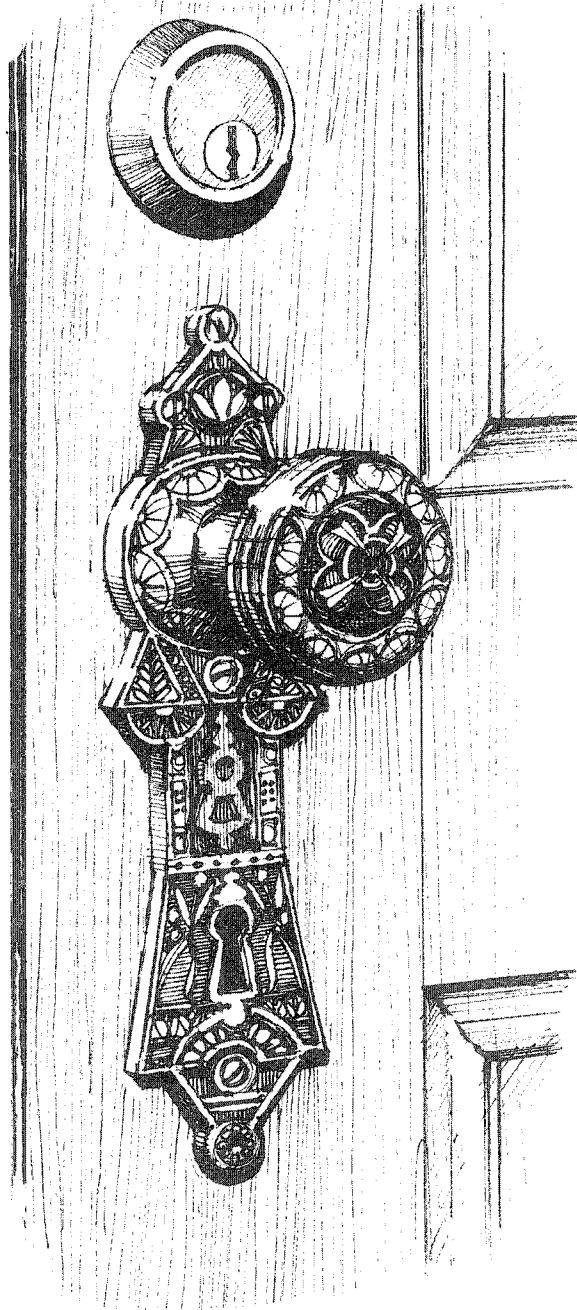

benefit of a building permit, lack fire resistive construction. Check to see if there is finished stucco, sheetrock, or other non-flammable surface installed from floor to ceiling on any garage wall that abuts a habitable portion of the house, or on any bearing wall. Also see if the door from garage to house is solid-core, or covered in sheet-metal. If not, apply for a building permit and correct the situation. The \$10 spent on the permit could save you thousands of dollars by preventing the spread of an automobile fire to the rest of the house.

SHEATHING

Sheathing is the weatherproof surface applied to the completed structure of the house. Visually, the original type of sheathing complements the other architectural features of the house, its shape, proportion, and ornamentation, so any change to another material has drastic consequences on the appearance of the building. Functionally, the siding protects the wood frame from the elements, and because it takes a lot of abuse from water and temperature extremes, it is commonly in need of repair. Always repair the sheathing in-kind, and stick with one kind only. Attempts to save work by changing to a modern, mass-produced siding are not worth the sacrifice in architectural integrity or resale value.

Wood Siding

Wood siding, the most widely used residential weatherproofing, comes in a variety of styles. With the exception of Craftsman houses, on which the finish is left natural, wood siding is always painted.

Design

One type of horizontal wood siding is the drop style, also known as "rustic." It has interlocking panels, and a flat surface which alternates with rounded channels or v-shaped grooves. Drop siding is characteristic of Victorian houses, and was occasionally used on the inside too, as the base molding. Half a decade later, drop siding came into vogue again on the Wartime Tract house, although the boards were of skimpier dimensions.

TYPES OF WOOD SIDING

HORIZONTAL SIDINGS

DROP SIDING

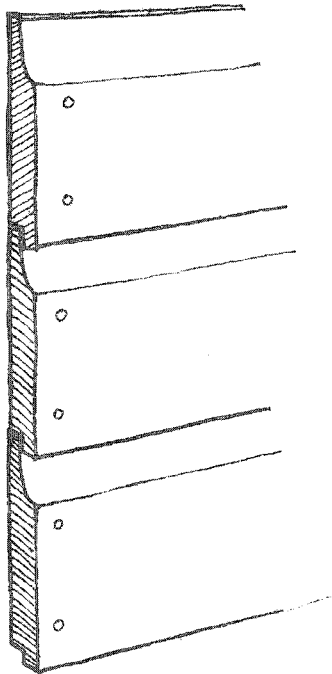

BEVEL SIDING

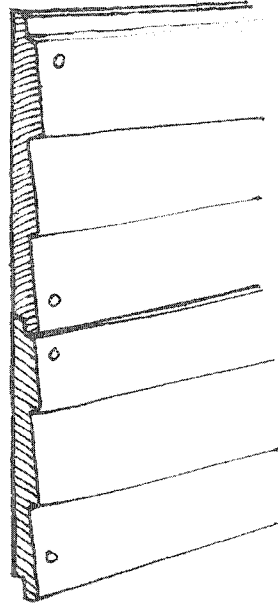

BEVEL SIDING
(CLAPBOARD)

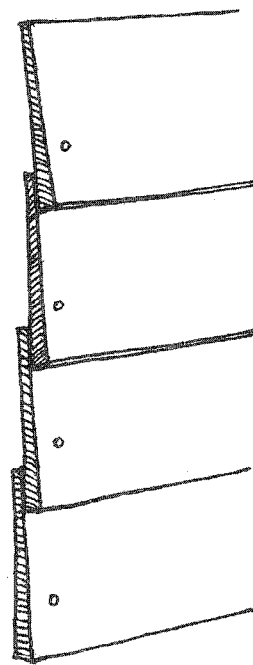

VERTICAL SIDING

(BOARD & BATTEN)

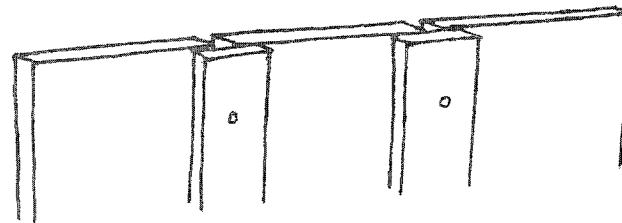
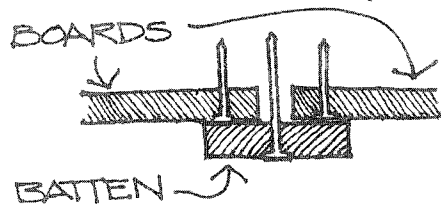

LONGER NAILS ATTACH THE BATTENS TO THE SHEATHING THROUGH THE $\frac{1}{2}$ " GAP BETWEEN THE BOARDS.

Another type of horizontal wood siding is the bevel style, also known as "lap siding," "shiplap," and "clapboard." (Pronounce it *kla-bird* with a silent "p".) In the East, in most home repair books, and on some Oakland bungalows, bevel siding consists of single boards, 8'-12' long, about a foot wide, and tapered at the upper end. They are nailed to the wood frame in overlapping fashion, through one or two thicknesses. In Oakland, however, the bevel siding characteristic of many Colonial Revival houses has a single unit that looks like three tiers combined. Functionally this allowed more expeditious installation and exposed fewer joints. Visually, it creates a more pronounced line every three slats, a subtle but extremely effective design device to modulate an otherwise repetitive surface.

The most common type of vertical wood siding in Oakland is board and batten, in which narrow strips are superimposed over broad planks. Board and batten is found on the San Francisco Stick style, the Brown Shingle style, the Craftsman Bungalow, and the Wartime Tract.

Damage and Repair

Cracked or decayed wood siding is an invitation to further trouble, especially from water seepage. Use the "pick test" to confirm any suspicions of rot. (Refer to the section on wood porches.) Peeling paint in the room behind the damaged siding is another danger signal.

Small fissures can be filled with putty or caulk. Cracks that are too wide to be sealed with caulk alone can first be stuffed with oakum, a specially treated rope-like material available on spools at plumbing supply stores.

Goat warps back into line with screws. Drill guide holes first, aiming for a stud, and keep the holes far enough apart to avert splitting the board. Counter-sink the screws and putty the holes. Reunitesplit boards by butting them together as tightly as possible and securing them with a screw, as just described. Fill the crack with an outdoor caulking compound like butyl. Butyl, both flexible and receptive to any kind of paint, comes in tubes to fit caulking guns, and in cans for application with a putty knife. The latter works best for large gaps.

Major cracks and deterioration require a replacement board. If the entire length must go, remove the nails with a nail puller (rented at \$2 a day at Lewis Rental). Countersinking and years of paint usually make the use of a hammer claw alone infeasible. As needed, replace rotted building paper and repair punctures with asphalt roofing compound. Treat the new wood with a "penta" (pentachlorophenol) preservative that can be painted, like Cehrung at \$2.45 a quart. Slip the new slat in place, and secure it with aluminum or galvanized nails. Countersink the nails, putty the holes, including those made with the nail puller, caulk the joints, and paint.

If less than half of the board's length is damaged, and you prefer to replace that part only, you can remove the entire span, as just described, and conduct surgery on the work table. Or, you can saw off the damaged segment right on the wall. This takes skillful manipulation of a circular saw, and risks damage to adjacent siding and underlying building paper. Consult a home repair book, like *Sunset Basic Home Repairs*, or the *Reader's Digest Complete Do-it-yourself Manual* for detailed instruction.

Due to the variety in design, it may be somewhat difficult to find drop or bevel siding that is milled precisely like the original. East Bay Lumber Supply and Blackman's Lumber are good places to begin the search. Redwood three-lap bevel siding costs 68¢/foot for 1" x 8"s, and 89¢/foot for 1" x 10"s. Redwood single-lap siding costs 43¢/foot for 1" x 6"s, 58¢/foot for 1" x 8"s, and 72¢/foot for 1" x 10"s. Redwood drop siding, with a "V" or cove-shaped channel costs 89¢/foot for the 1" x 10" size.

Board and batten is a lot easier to repair than horizontal siding. The battens are face nailed, and willingly accept pry bars. Replace damaged pieces in full.

A devastating problem throughout Oakland is the interment of wood siding in a grave of stucco. In some cases this was a voluntary, but thoroughly misguided effort. In others stucco was the only solution to an Oakland code regulation which re-

quires a one-hour fire-rated exterior wall on any hotel or apartment house that is three or more stories tall. Thus, three-story single-family Victorian, Colonial Revival and Brown Shingle houses that are converted to multi-family dwellings must have one-hour rated exterior walls and the only known solution is to bury the wood frame in stucco. This regulation is retroactive to 1948. Buildings converted prior to 1948 are not required to comply with the one-hour rating, and may be left with the wood siding as is. During the 1960's, however, this regulation was interpreted otherwise, and countless three-story, wood frame houses converted to multiple occupancy were stuccoed as a result.

To reincarnate the architectural integrity of a single-family, wood frame house that has been stuccoed, the stucco must be removed. This painstaking job is compensated by the sense of discovery of a lost treasure. Attack the stucco a section at a time. With hammer and chisel, make a 2" wide score in the shape of a square about 3' long on each side. Pry off the stucco with a crow bar. Use clippers to remove the chicken wire, and your hands to rip off the building paper. (Refer to the construction illustration in the section "Facade: Stucco.") Remove the nails with a claw hammer, and you're back to clapboard. According to Jim Jensen, an Oakland carpenter who restores Victorians, the original siding underneath is often in "amazingly good shape." Be sure to patch nail holes and gouges with wood putty before repainting. (Refer to the discussion of removal in the section "Mass Produced Siding.")

Wood Shingles

Wood shingles are a flexible siding material because they can fit around obstructions, and cover misshapen walls. The standard shingle is 16", 18" or 24" long, made of redwood, or nowadays, cedar. Their rustic appearance is essential to the architecture of the Craftsman Bungalow, and of course, to the Brown Shingle style. Shingles of various shapes, like octagons and diamonds, form characteristic patterns in the textural quilt of the Queen Anne facade. Finely corrugated shingles, thinner and more tidy than their predecessors, are common

SHINGLE PATTERNS

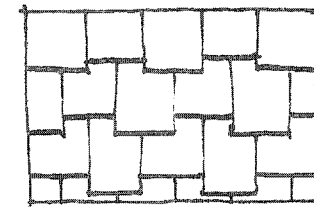

SQUARE BUTT

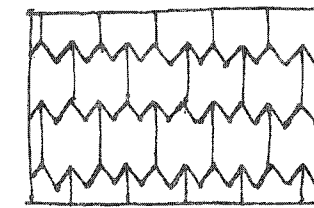

SAWTOOTH

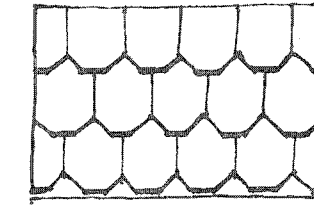

OCTAGON

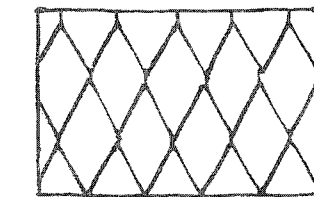

DIAMOND

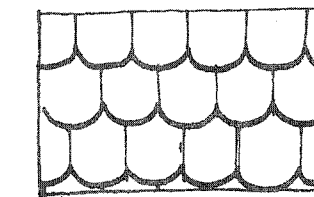

FISHSCALE

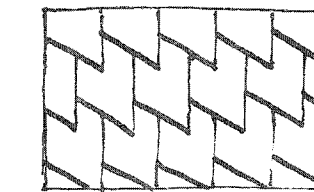

CHISEL

to Wartime Tract houses. Shakes are irregularly shaped shingles exposed 12" to 24" beyond the overlap, and are sometimes found as siding as well as on the roofs of Provincial houses.

After decades of exposure, **shingles are subject to rotting, splitting and warping.** Nail split or warped shingles back down with galvanized or aluminum nails. To waterproof the patch, slip a piece of roofing paper of the same size underneath the shingle before securing it. Rotted or badly damaged shingles can be replaced individually, but if 10% or more in scattered locations need attention, it's time to reshingle the whole wall.

Replacing worn-out shingles is a good job for an amateur. Several hours in advance, soak the bundle in a bucket of water. This wards off swelling in the first rain, and the likelihood of popping. Remove the damaged shingle by slipping a hacksaw blade under the bottom of the good shingle above

SHINGLE INSTALLATION DETAIL

PLACE NAILS ABOVE
TOP OF PREVIOUS COURSE
½ 3/4" FROM EACH EDGE,
2 NAILS PER SHINGLE.
NO MORE THAN 7½" OF A
16" SHINGLE SHOULD BE
EXPOSED.

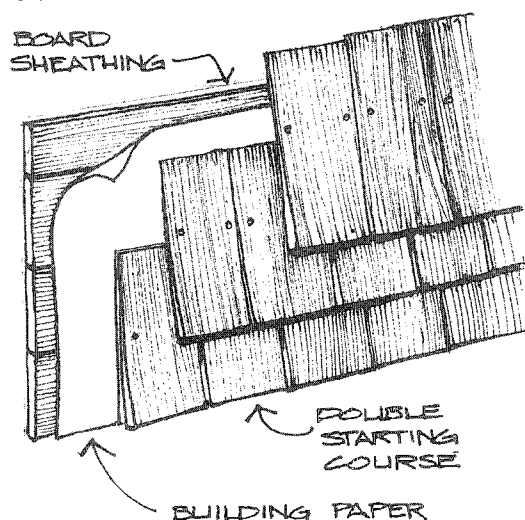

it, and cut the nails that hold the top of the damaged piece. In the same way, cut the nails at the bottom of the damaged shingle if necessary. Splinter the shingle with a chisel, and pry out the nail stubs with the claw of a hammer or pincers. Slip a new shingle of the same size, thickness, and approximate color into the space. The top should be overlapped by the upper shingle course; the bottom should overlap the lower shingle course.

Shingles can be finished with stain, preservative or paint. Painted shingles are appropriate to the Queen Anne and the All-American Ranch styles. For First Bay Tradition houses, paint is the least desirable alternative, not only because it is architecturally out of place, but also because it clogs the pores of the wood which allow the grain to expire any absorbed moisture. Some people mistakenly paint shingles in order to conceal discoloration, but this darkening often bleeds right through the paint as well. It is a better idea to apply a fresh coat of stain.

If the shingles on a Craftsman or Brown Shingle house have already been painted, when it's time to repaint the most fashionable color to use is a raisin brown which simulates the appearance of naturally aged redwood. The brown, unlike the pea-green or gray it is probably covering up, provides a visual foil for the rich green of foundation shrubs and nearby trees.

If the shingles are still natural, and have acquired an enviable patina with age, maintain them with a coat of clear preservative. Cedar turns a silver gray, and redwood a raisin brown. If they have already been stained, stick with stain. In contrast to paint, whose pigment is opaque and hides the wood beneath it, stain has only enough pigment to color the wood without concealing the grain or suffocating the fibers. Check the label, or ask the paint dealer for a stain with a preservative in the suspension.

The difficulty of replacing shingles in scattered locations is matching the new slab with the weathered look of the rest of the wall and avoiding the buck-shot look. If you anticipate shingle repairs in the next year or so, buy a square of shingles now and leave them in a safe spot outdoors to weather on their own.

To match shingles in shorter order, add drops of stain to paint thinner until it tests a tad lighter than the weathered wall. Brush the solution on the new shingles in the same direction as the grain. The pigment darkens the wood enough to camouflage its youth, while the thinner reduces the oil content of the stain which would otherwise deter natural weathering. Use the same staining technique to make cedar shingles blend with redwood originals, as replacement redwood shingles are practically impossible to find. When selecting any stain, remember that the color looks darker in the can or on a swatch than it does in natural light on a large building wall.

Save time by applying the stain to the sides of the bundle before untying it, and to the face of each shingle prior to nailing it into place. While you're at it, stain some extras for future repairs and leave the spares outside to keep pace in color with their counterparts on the wall.

Shingles are sold in packages called squares. A square is made up of four bundles, and a bundle is adequate to cover about 25 square feet. Conventional cedar shingles, purchased in quantities of ten or more squares, cost \$65 per square for #1 quality, and \$47 per square for #2 quality. The #2 type is not as easy to split in a straight line, nor as flat, as the #1 type. A single square of #1 shingles costs \$72.50, and a single square of #2's costs \$53.50. Queen Anne style shingles of distinctive shape are available at San Francisco Victoriana, and cost about \$30 for a bundle which covers 16 to 18 square feet.

Stucco

Stucco is a composition of Portland cement, sand and lime, applied like plaster to the exterior of wood frame houses. In Oakland, stucco belongs on the California Bungalow, Prairie School, Mediterranean, Provincial, and some All-American Ranch Style houses, like those along Malcolm Avenue in the East Oakland hills. Unfortunately, stucco is misused in attempts to modernize Victorian, Colonial Revival, and Craftsman houses, whose rightful weatherproofing is drop siding, bevel siding, and shingles, respectively. The section on wood siding addresses the removal of unwanted stucco.

Stucco is prone to surface damage, which begins with hairline cracks, usually near windows and doors, and to interior damage, which begins with leaks in the flashing or inadequate ventilation in the crawl space. The sections entitled "Crawl Space," "Stucco Porches," and "Roof" discuss the problem of structural rot.

The repair of narrow surface cracks prevents more serious damage from getting a start, and is fairly simple to do.

1. Use a knife or a spatula to open the crack to sound stucco. Use a hammer and cold chisel to make the edge of the crack wider on the inside than at the outside edge. This inverted "V" will lock in the new stucco. Brush away all loose material.
2. Prepare a dry mix mortar, adding water until it has a firm yet pliable consistency. Dampen the crack and pack the stucco in tightly with a putty knife or trowel. Overfill the crack if it extends through the stucco to the base material. Let it dry for about 15 minutes, then work it down until flush.
3. Moist cure the fresh stucco with fine spray from the garden hose for about three days, once in the morning and once at night. Dry mix mortar costs \$2.29 per 75-lb. bag. A putty knife and trowel cost under \$5.

The repair of major patches is a more complicated procedure because it requires attention to the wood framing, sheathing, wire mesh, and to all three coats of stucco, as illustrated. Refer to a home repair book, like the *Reader's Digest Complete Do-it-yourself Manual* for more explicit instructions.

Make sure the patch matches the rest of the wall in texture and color both. Get a sandy finish, for example, by trowelling the stucco with a float as it begins to set up. Get a swirled finish by using an old brush to scrub or jab the surface.

Stucco has a natural color all its own, originally appreciated for the graininess of sand and cement employed without benefit of paint. If the house is

STUCCO CONSTRUCTION

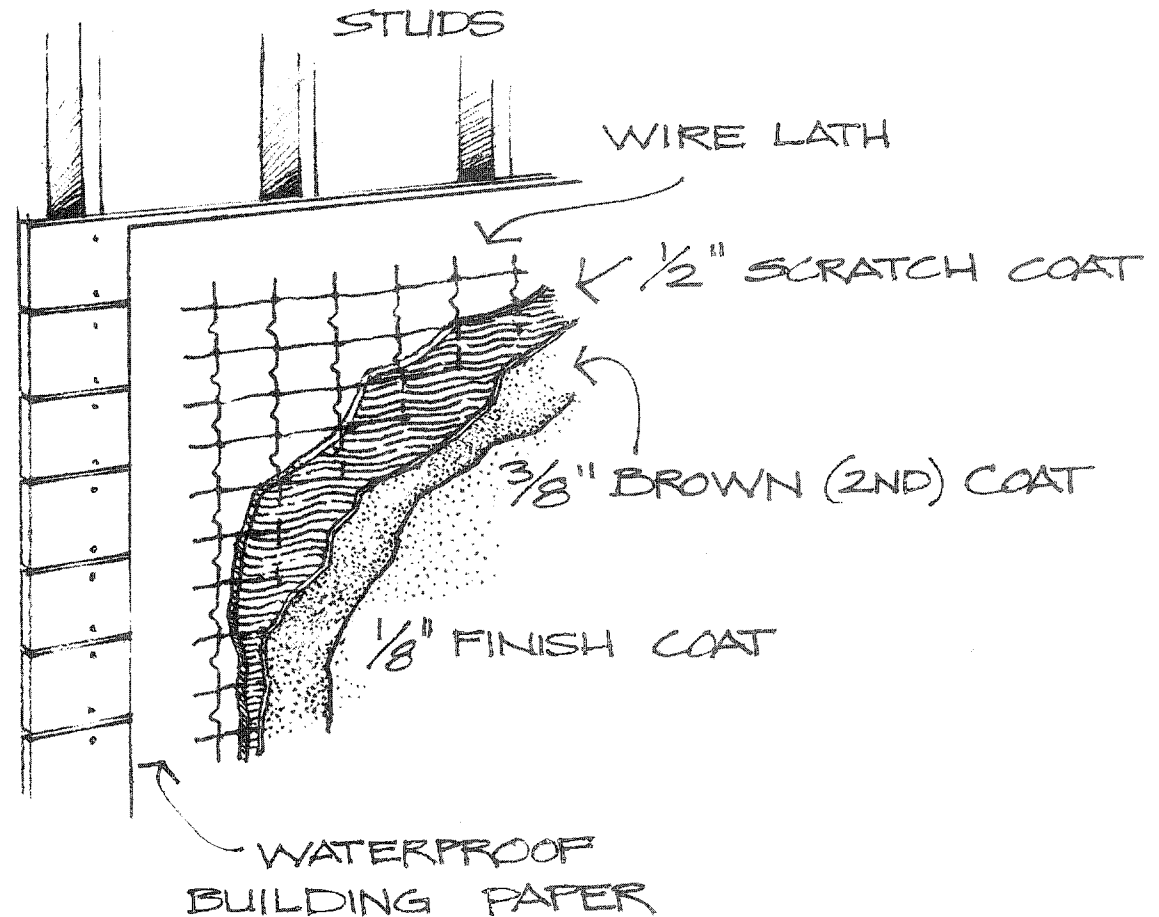

still this unadulterated gravelly-gray, leave it as is and perpetuate its distinctive place in the history of building materials.

If the stucco was originally treated with an integral color, then do the same when you patch it. Add mineral pigments to the mortar for the final coat, mixing it well enough to produce a uniform color. On large jobs, the pigment should weigh no more

than 5% of the total weight of the masonry cement. This is a difficult calculation in small quantities, so use a cook's eighth-teaspoon to add a little bit of the powder at a time. Note your final recipe right on the box of pigment for future reference. Available integral colors include pink, yellow, green and tan.

If the stucco is colorful thanks to paint, then consult

the section "Paint" for advice on color selection. If the stucco has not been painted previously, a sealer is probably necessary first.

Mass Produced Siding

Beginning in the 1950's, mass production and mass marketing conspired to alter the appearance of the nation's homes by manufacturing and promoting products to "modernize" the house. Because these items were not designed for any particular architectural style, they are so anonymous that they go with no architectural style at all. They were conceived to look enticing in a magazine ad or display case, but not necessarily on the building itself. Off-the-shelf items available by catalogue number instead of by design characteristics became the mainstay of the new pastime called "home improvement." They usually did more harm than good. Consumer-oriented house parts, like flush doors, aluminum frame windows, and plastic ornamentation, are discussed in their respective sections. But the **greatest indignity heaped on American residential architecture was modern siding.**

Mass produced siding invariably pretends to be something it is not: plastic called "stone," asbestos called "shingles," aluminum shaped like clapboard. The imitation is never convincing because the shallow quality of the siding, its superficial aspect, is so patently obvious. In Oakland, modern siding usually defaces Victorian and Colonial Revival houses, Craftsman and California Bungalows. Often a particular brand of siding covers several houses on the block, altogether obscuring their individuality. This is testimony to a persuasive door-to-door salesman who single-handedly destroyed the charm of the neighborhood.

Asbestos shingles are brittle, tile-like slabs made of mineral fibers. Corrugated and thin, they are 12" high, and broader than the wood shingles they set out to imitate. Asbestos shingles come in nondescript tones like gray-green, gray-pink, and speckles. Aluminum and vinyl siding are extruded pieces of metal and plastic, respectively, shaped like shiplap, but much thinner and lighter weight. Aluminum is prone to dents, is noisy in the rain, and tends to

peel if not properly anodized. Vinyl reacts with light in the atmosphere, becoming brittle and deteriorated if not treated with an ultra-violet inhibitor. Tarpaper brick is like asphalt roofing in composition. The grout is represented by the gray background, and the bricks by rectangles of overly-bright red, with the texture of sandpaper. Other disastrous substitutes include ground stone or brick crumbs suspended in plastic. A fibrous spray that sheathes the building in a filmy cloud, is the worst atrocity of them all. These products are used singly or in combination to cover an entire house, or just the facade or base.

Do not add modern siding to an old house. Aside from the obvious injustice to the building's architecture, modern siding has other disadvantages. For example, there is the hidden expense of adjusting window casing, drip cap, and door trim to compensate for the added wall thickness. Visually, the modern siding replaces "line" with "texture" and makes the building look choppy instead of solid. Breaking the facade up into different surfaces also makes the house look smaller than it actually is. The so-called "random" pattern that phony brick and stone sidings promise turns out to be a monotonously repetitive pattern when spread across a wall of any size. Finally, there is something disturbingly dishonest about using a siding which is bogus in its own right and does not belong to the architecture of the house to boot. No matter what modern siding may save you in future maintenance, it can never compensate for the destruction of the building's character.

Unhappily, the addition of mass-produced siding is a miserable process to reverse. There is no telling what lies below without serious excavation. For a lucky few, the original siding is still intact. More likely, however, ornamentation has been sheared off, sections of the original siding have deteriorated, and gaps have been filled in with scrap lumber. Therefore, do not remove modern siding until you have well thought-out plans and sufficient funds to confront whatever the removal reveals. Sample exploration at enough different locations gives an experienced eye some clues to predict the condition of the under raiment. Check above windows and doors, near ground level, near the roof line, and

mid-wall. Schedule it so the house is never without siding during the rainy season.

Removal is basically an un-nailing operation, with the difficulty factor depending on the size of the siding unit. Vinyl and aluminum siding are the largest, and therefore the easiest. Tarpaper brick and compressed stone cover less square footage per unit, and so take more time to undo. Asbestos shingles must be removed one by one. Use a crowbar, or chisel the shingle apart enough to get purchase on the nail, and pry it out with a hammer. Asphalt shingles are secured at the lower edge through one thickness only, so work from the top down. A dumpster within tossing distance and decent aim simplify the cleanup operation considerably. Textured spray paint is at the bottom of this list because it takes sandblasting to remove.

The choice between repair or replacement of the underlying siding or shingles takes careful evaluation. Calculate labor and material costs for puttying nail holes, caulking seams and repainting the original, compared to removing the old siding altogether and starting again. The latter often proves more economical, though neither could be considered cheap.

ORNAMENTATION

Generic ornamentation is essential to the architectural character of a house. Victorian styles are renowned for their individualized and ostentatious decorations. Colonial Revival houses are more reserved, with a classical motif. First Bay Tradition houses emphasize the structure itself for its ornamental properties. Period Revival houses have stone, tile, and wrought iron to accent their foreign flavor. (Real wrought iron is made of flat straps or solid bars of iron, heated and bent or twisted into shape. Imitation wrought iron, the more common product, is a hollow, extruded rod made of steel or aluminum, with riveted, rather than welded, joints.)

The ornamentation on Victorian and Colonial Revival houses is the focus of this discussion. Familiarize yourself with the vocabulary in the illustra-

tions, and determine whether the parts are made of wood, plaster, or pig iron.

Wood Ornamentation

Removal

It is often necessary to remove ornamentation in order to repair the underlying structure, or to facilitate repair of the ornament itself. Do so with extreme care and patience. Study the part first to see if it is attached with a toe-nail or a face-nail. Use the broad surface of a prying instrument, like a crowbar, working it in very gradually to loosen the knobs from the supporting post and beams. When space allows, place a piece of wood or corrugated cardboard between the tool and the structural wood to avoid denting the surface as you unnailed.

A cedar shingle is a terrific tool for removing ornamentation. It can be split lengthwise so that its width is the same as the part in question, and pressure can be distributed evenly. It is thin enough at its tapered end to allow gradual insertion, and, because it is wood too, it will not scar the ornament the way a metal tool would. The shingle also has a fail safe mechanism: when it bumps into a nail, it will automatically split.

If paint masks the joint between the ornament and its backing, score the seal with a putty knife first. Gently tap the shingle into a crack on an unnailed edge, tapered end first, until the force of the shingle lifts the ornament away from its support. Ease the shingle out, keeping it horizontal. Do not use the shingle as a prying mechanism or it will break off. There should be enough space now to permit purchase on the nail with claw hammer or crowbar. (Refer to Chapter 5, "Trim," for more on removal techniques.)

Put rudimentary labels on the pieces of ornamentation with an indelible marker to help in reassembling the pieces later on. Some people find a sketch a convenient record. Others prefer a "before" photograph. Store the collection of ornamental parts in a vandal-safe and weather-protected place.

Repair

If any of the parts split or crack during the removal

REMOVING WOOD ORNAMENTATION

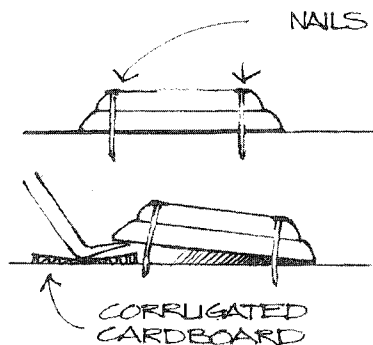

WHEN USING A PRYING TOOL, WORK SLOWLY AROUND PERIMETER OF ORNAMENT IN STAGES. APPLY PRESSURE BE- NEATH NAILS TO PREVENT SPLITTING. SLIP THIN WOOD OR CARDBOARD BENEATH PRYBAR TO CUSHION THE STRUCTURE.

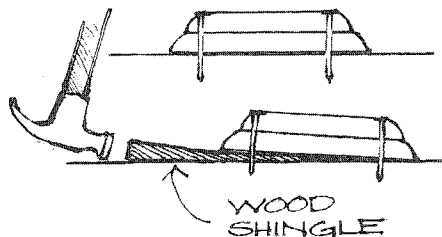

AFTER OPENING A SMALL CRACK WITH A PUTTY KNIFE, DRIVE ONE OR MORE PIECES OF WOOD SHINGLE UNDER ORNAMENT, FORCING IT UP. COMPLETE REMOVAL WITH CLAWHAMMER OR PRYBAR, IF NECESSARY.

process, make them solid again by using a white glue, like Elmer's. Clamp the mended pieces with a vice or, with strapping tape.

If a portion of the ornament shows signs of rot, arrest decay with a penetrating epoxy available from a boat supply store. "Git-Rot" encapsulates the wood fibres in resin, and hardens into a resilient adhesive that bonds the wood particles together, making it more plastic than it is wood. A small container costs about \$4.25. Marine-Tex, at \$2.25, is thicker, like spackle, and can be used to fill in gaps after the fibres have been treated with Git-Rot. For the penetrating epoxy to be effective on a boat surface the wood must be honeycombed with drill holes, no more than 2" apart. Adjust this requirement accordingly, based on the size and strength of the part in question. These products are available at Marine Parts Company in Oakland.

If the ornamentation came off in one piece, you are spared these preliminaries. Scrape off the ridge of paint, and other loose paint flakes to achieve a fairly even surface. A small scraper suitable for curved surfaces can be purchased for about \$3.00 plus blades. Fill any holes and cracks with wood putty.

Replacement

If the ornament is beyond repair, save the pieces and use them as a pattern. Even if the intricate detail is lost in reproduction, combining standard geometric parts in the right proportion is acceptable when the visual relationship among the parts remains the same. For example, perpetuate the appearance of a corner board by using a plain 2" x 8", or keep window trim broad enough by using a 2" x 6". Imply a belt course with a 1" x 8", topped by a 2" x 2" for molding. A rather elaborate proportional reproduction of a cornice is illustrated.

If you prefer an accurate duplication, bring the part, or its pieces, to San Francisco Victoriana, a firm specializing in the reproduction of period house parts. Duplication of a turned baluster in redwood, for example, costs about \$10. Or, consult a local carpenter competent in custom work.

Another way to duplicate wood ornament is to make a latex cast, and replace the wood original with a plaster facsimile. Do this in the same manner

ORNAMENTATION VOCABULARY

ITALIANATE

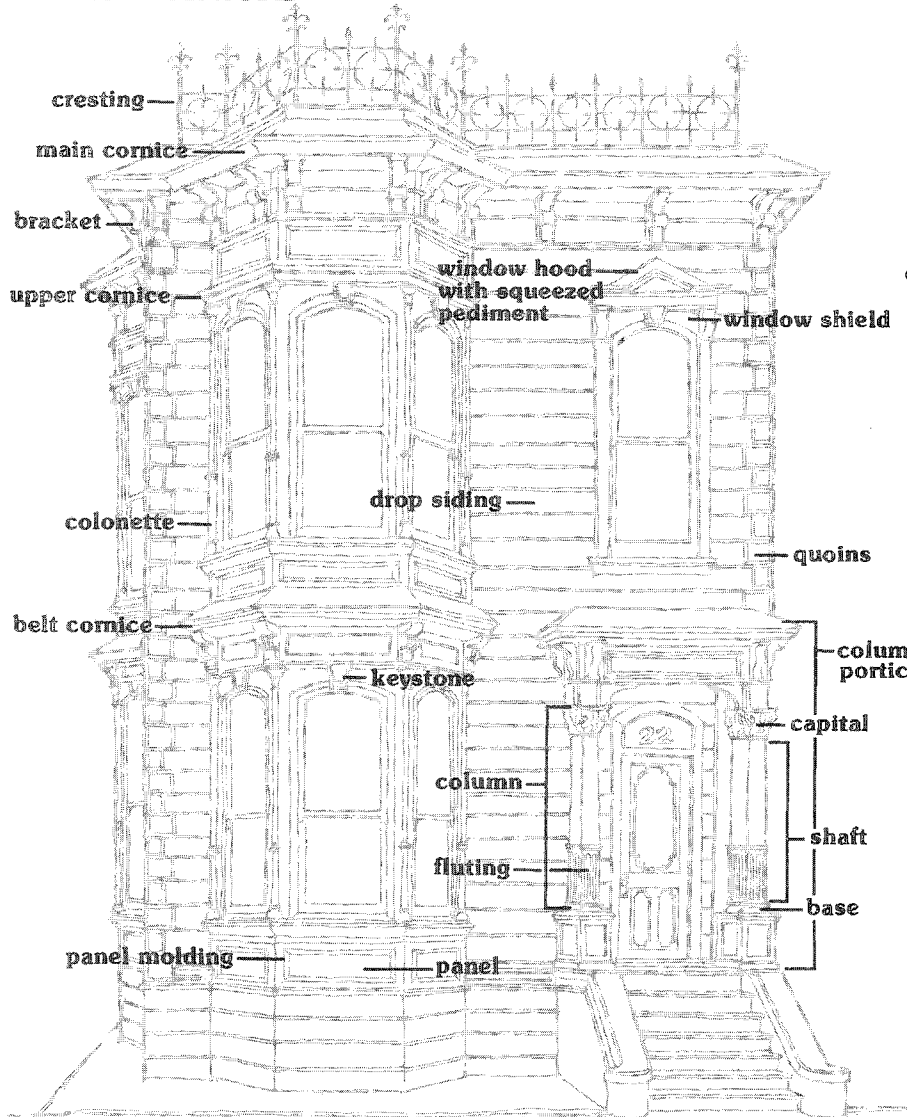

CLASSIC BOX

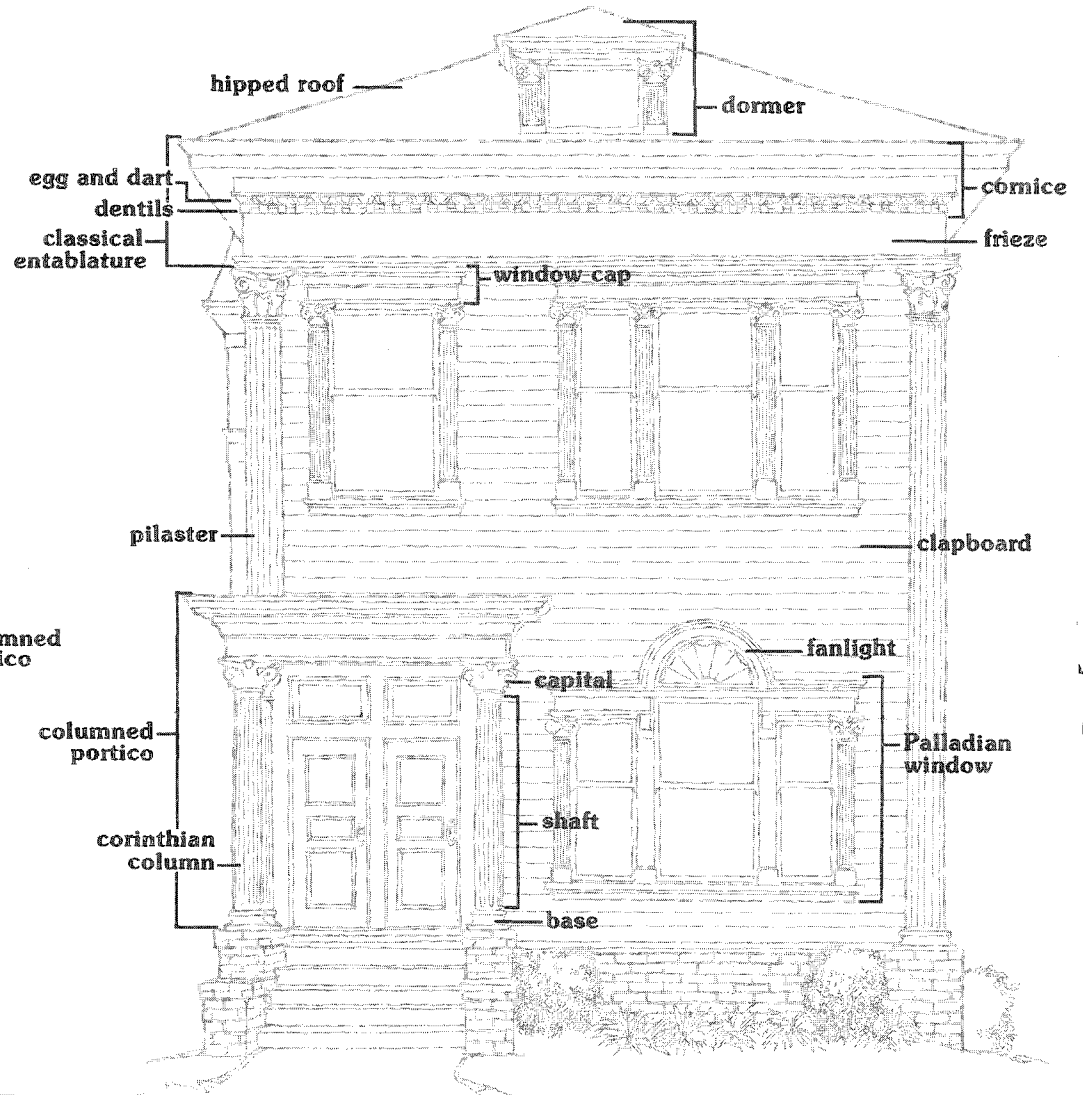

QUEEN ANNE

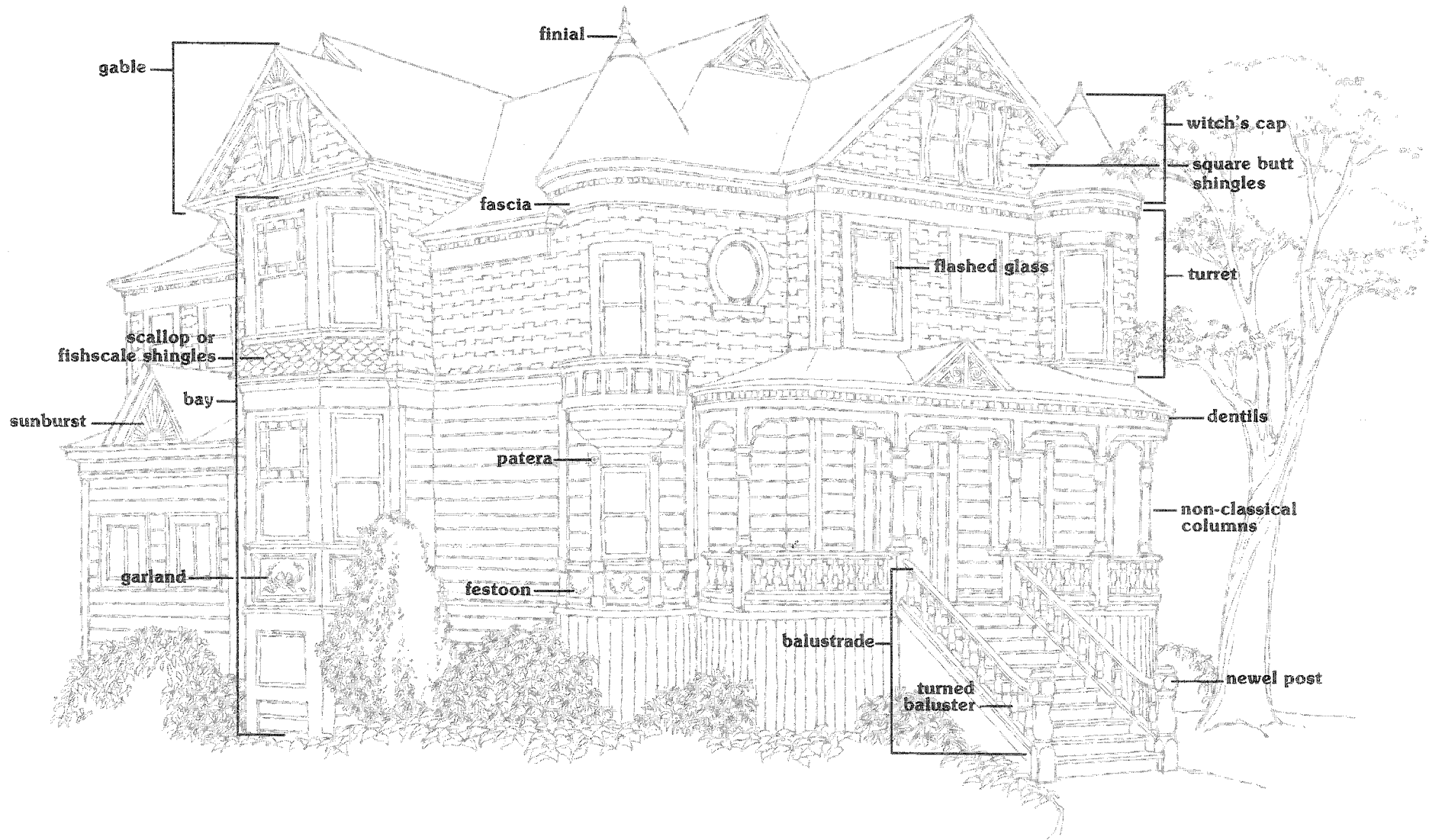

as making a cast from a plaster original as discussed in the next section.

If you enjoy a hunt, try to locate substitute parts at a salvage yard, like Campanella, Sunrise, or Berkeley Architectural Salvage. The new acquisitions should match what you've already got, or come in a set. Otherwise the result will be a hodge-podge that would dismay even a Victorian eye. Even though it is more readily available, never use the modern, plastic ornamentation that pretends to look "oide." These products look chintzy because they are more akin to Christmas tree decorations than they are a legitimate reproduction of architectural features of the house.

Re-installation

Treat all the parts, both old and new, with a wood preservative. By doing this before you reassemble, all surfaces receive equal protection. You can be sloppy here. Spread the pieces out on a plastic drop cloth and brush them well. When they are thoroughly dry, and the underlying structure has been repaired, nail the pieces of ornamentation back on.

Tighten pieces of ornamentation which have come loose with screws, 4" or longer. Old wood is pretty tough, so first drill a pilot hole, a little smaller than the screw itself, and lubricate the screw threads with soap. To maintain ornamentation, keep up with caulk in the joints and a decent coat of paint.

Plaster Ornamentation

The yen for sculptural ornamentation in the period of Victorian and Colonial Revival architecture was often satisfied with plaster instead of wood. On the exterior it was used for capitals on classic columns; rosettes, festoons, and garlands at the cornice; and, for oddball accessories on eclectic facades. A striking example is the garish quartet of houses on 16th Street between Market and Brush.

Plaster ornamentation is often deteriorated or missing either because the material itself has weathered, or the attachment has failed and the decorative piece has fallen off. If you have at least one original piece of ornamentation left, remove it carefully and make a mold from it to cast replacements for its

PROPORTIONAL REPRODUCTION: A CORNICE

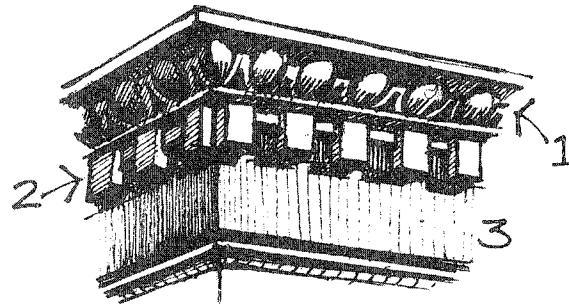

SOME ELEMENTS OF A
CLASSICAL CORNICE:

- 1 EGG & DART PATTERN
- 2 DENTILS
- 3 FRIEZE BOARD

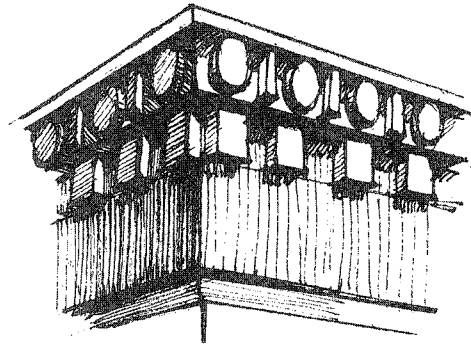

PROPORTIONAL RE-CREATION

- UPPER & LOWER BLOCKS ARE CUT FROM STOCK LUMBER
- USE CIRCLE SAW DRILL ATTACHMENT FOR CIRCLES OR JIGSAW FOR OVALS
- USE STOCK MOLDING (QUARTER ROUND, COVE, OR OGEE) UNDER THE FRIEZE BOARD

siblings. Use a special product called Liquid Latex, available at Douglas and Sturgess, San Francisco, for \$13.50 - \$18.25 a gallon. Follow directions on the label, brushing on consecutive coats and letting each dry between applications until a rubber mold is formed. Let it cure for a few days, and remove the pattern piece. Cast the mold you just made with a product suitable for exterior use, like Hydrocal which costs \$12.50 for a 100 pound sack. If you plan to bolt the new piece to the facade, embed the bolt in the damp hydrocal before it sets. Otherwise, the plaster ornament can be screwed or nailed to the building, by first drilling holes in the piece with a carbide-tipped or masonry bit. For more detailed information on casting plaster reproductions, consult the March, 1974, issue of *The Old-House Journal*.

If there is no original plaster work left to use as a mold, or if you prefer to buy replacements, visit San Francisco Victoriana, Western Art Stone, or a local salvage yard.

Prevent the loss of plaster ornament in the future by keeping the seal between ornament and facade well caulked and water-free.

PAINT

A good coat of paint is one of the most important defenses a house has against the elements. It forms a continuous film that sheds water, and water is the number one source of building damage. Paint is also one of the most important visual choices to make. The color combination decides the overall appearance of the house, and contributes to the character of the entire neighborhood.

When to Paint

Trouble signs that point to a new paint job are: alligating, checking, cracking and sealing, blistering and peeling, and exposed wood. If the paint rubs off like powder, that is quite normal. It is called chalking, and good outdoor paint is designed to chalk so that rain will wash away the dirt and leave a clean surface. If the paint is dirty or faded but it

COLOR WHEEL

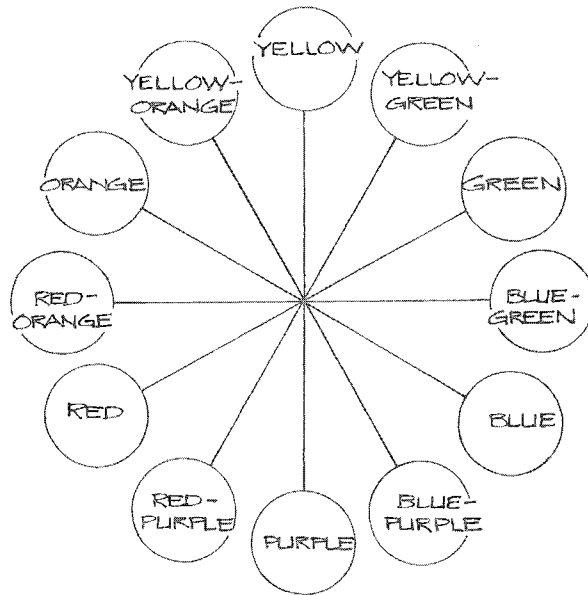

still provides a protective seal for the wood or masonry underneath, it can be freshened up with a mild detergent. Trim is more vulnerable to weathering than the body of the house, so if the paint shows signs of wear only there, limit the job to repainting the trim this time around. Don't rush repainting, as excessive coats create a thick film that can promote damage.

Do not undertake a paint job until any problems with leaking water have been solved, especially the repair of gutters and downspouts. Many people prefer to leave the paint job for the crowning touch to the rehab process. Others paint early on, finding it easier to get loans and insurance if the house looks presentable. Still others paint the house just to make it look attractive to prospective buyers. As effective as this sales pitch may be, it is somehow unfair to the new owner who has different taste and would like to express it. Even more important is the fact that high quality paint products more than pay for themselves in the long run, but a person about to sell a house has little incentive to use an expensive product. If the buyer does the job instead, he or she would wisely select a top-flight product that

would prolong the life of this paint job, and make subsequent paint jobs easier.

The Painting Process

There are four stages to painting the exterior of any house: surface preparation, color selection, paint application, and clean-up. Surface preparation is at least half the job, and it is worth every extra day it takes because good preparation is the key to the ultimate success and duration of the paint job. Preparation involves:

1. removing the loose paint with wire brush, scraper, chemicals or heat
2. fine sanding the scraped surface to feather-out rough edges
3. light sanding the smooth base to give it some tooth
4. nailing, puttying and caulking, as needed
5. cleaning off all dirt and dust.

While lavishing so much attention on the facade and exploring its details with your hands, think about color selection. Guidelines for this important decision are discussed in detail shortly.

Paint application is the fun. Painting involves:

1. using a primer as needed
2. keeping the paint thoroughly mixed
3. brushing or rolling on the color in an orderly way.

On single-story houses it is easier to paint the body of the house first, and then go back and do the trim. On two-story houses, where scaffolding must be rented at \$200-300 a month and moved with some commotion for each change in location, it is easier to complete both base and trim for a section at a time. Then all that's left is clean-up. Refer to reputable home repair books, like the *Reader's Digest Complete Do-it-yourself Manual*, and to your local paint dealer, for more detailed instructions on the proper techniques for surface preparation and painting.

The question of paint product selection is summarized in most home repair books. Also, refer to *The Old-House Journal*, July, 1976, at the Oakland Public Library, for instruction on deciphering paint can labels and differentiating between binder, thinner and pigment.

The City of Oakland has special programs which offer free paint to eligible property owners. Refer to Chapter 6 for the details.

Color Selection

Paint is the single rehabilitation decision which can unify or destroy neighborhood quality. As a positive influence, color is contagious. It takes only one house to start the trend toward a fresh coat for the whole block. As a potential threat, an odd color

VALUE

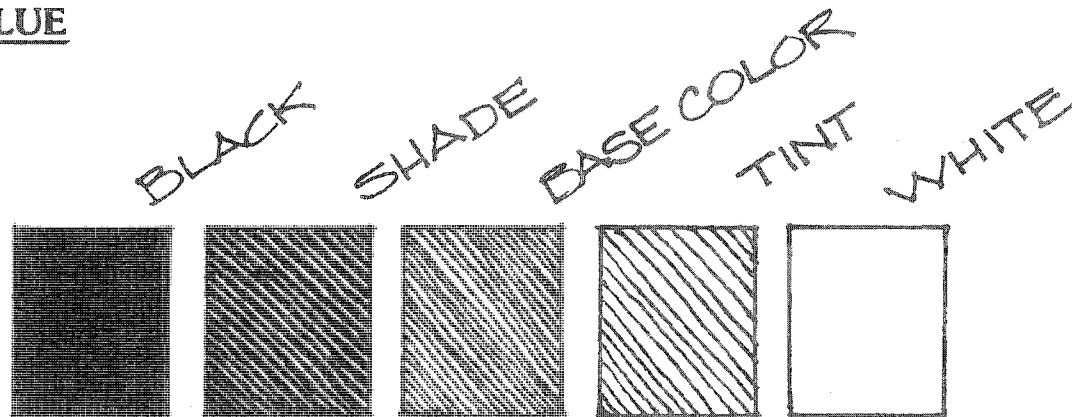

selection is like a leper in the local environment. Blending or contrasting colors with nearby buildings is as critical as choosing compatible colors for the house itself. In case of doubt, assume a low profile. If, for example, the street scene is pastel, stick with pastel. This is especially important if adjacent houses share architectural style because harmony is so easily achieved that cacophony is difficult to forgive. Where there is little landscaping to soften the masses, and few trees to filter view of the facade, considerate color selection is even more critical.

Use the paint palette to help a house assert its authentic personality, rather than your own. As with other aspects of appearance, the **historically correct choice is an attractive and safe one**. The further you stray from historical guidelines, the greater the chance of downgrading the general appeal and resale value of your home. For those determined to try something different, or for greater assurance in selecting the precise hue, tone and value for a historical palette, here are some hints.

First, look at the house as a whole. Study its shape and proportion, the arrangement of the parts and their relationship to one another. Does the building resemble a square, an upright rectangle, or a rectangle on its side? Discover the role the roof plays. Does it cloak the building or is it out-of-sight? See if the house sits on a base, like a pedestal, or if it is squat on the ground. Appreciate its texture. Is it appliqued and three-dimensional or flat and plain? These observations will make your eye informed enough to proceed with color selection.

Oakland houses are seen predominantly from the street, so the facade is the starting point for a color selection equally suitable to the rest of the building. Think of the facade as a picture, a composition of solids and voids. The walls appear as light planes punctured by the dark holes of the windows. The change from one material to another creates a dividing line on the facade, as do the sequence of stories, and the bands of ornamentation. A **successful color combination unifies the architectural elements into a single picture, without denying the distinctive features lively emphasis**.

Decide how much of the facade is actually paint-

PARTS OF A HOUSE TO PAINT

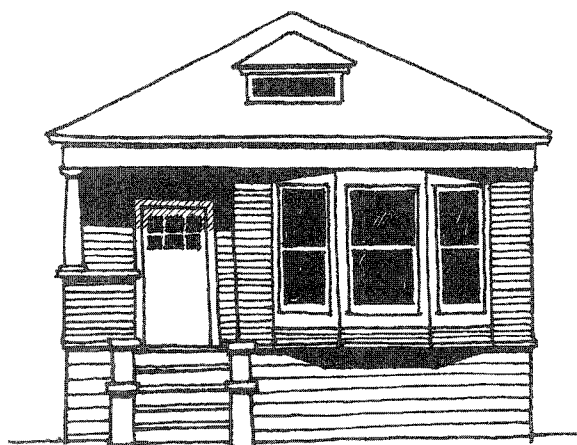

A HOUSE CAN BE DIVIDED INTO FOUR SECTIONS REQUIRING PAINT. A ONE-COLOR PAINT JOB UNIFIES THESE SECTIONS VISUALLY, BUT MAY LOOK DULL ON SOME HOUSE STYLES. DARK COLORS ARE OPPRESSIVE WITHOUT THE RELIEF OF LIGHTER-COLORED TRIM, SO SHOULD BE AVOIDED WHEN ONLY ONE COLOR IS TO BE USED.

able. There is probably a lot more window space than you thought. Do not paint: stained shingles, brick, stone, untreated wrought iron, the wood stickwork on Brown shingle or Craftsman houses, the chimney, the roofing, nor any of the modern "miracle" sidings. Do paint: the base, the trim, the window moldings, the moving parts of wood windows, and the wood siding or stucco body of the house.

To most people, color means hue, an arc of the rainbow. Pure hues are so vivid that they have unpredictable effects when used in their basic state, so the hue is modified. The hue is made into a

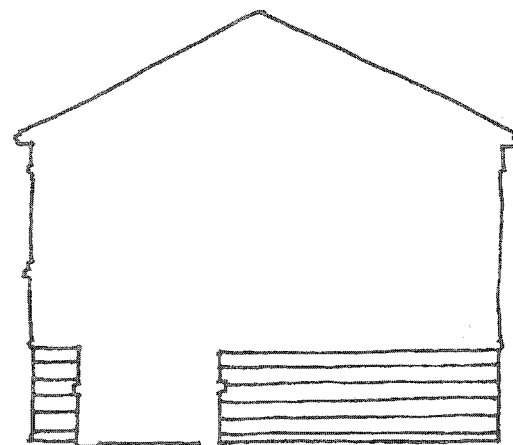

THE BASE. VISUALLY, THE BASE SUPPORTS THE REST OF THE HOUSE. FOR THE HOUSE TO "REST COMFORTABLY" ON THE BASE, THE BASE AND BODY COLORS MUST BE COMPATIBLE. A GOOD CHOICE FOR A THREE-COLOR PAINT JOB IS A DARK SHADE OF THE BODY COLOR FOR BASE AND TRIM, WITH WHITE FOR THE SASH COLOR.

darker color by the addition of black, and this is called a **shade**. The hue is made into a lighter color by the addition of white, and this is called a **tint**. Or, the hue is muted by the addition of its complement, the hue opposite it on the color wheel, and this is called an **earth tone**. Browns are also made by mixing complementary colors.

Limit the number of different colors on the house to three at most, for economy and appearance both. As a rule of thumb, pick a light or muted color for the body, a compatible darker shade for the base, trim and window moldings, and white for the moving parts of the wood-frame windows. For a

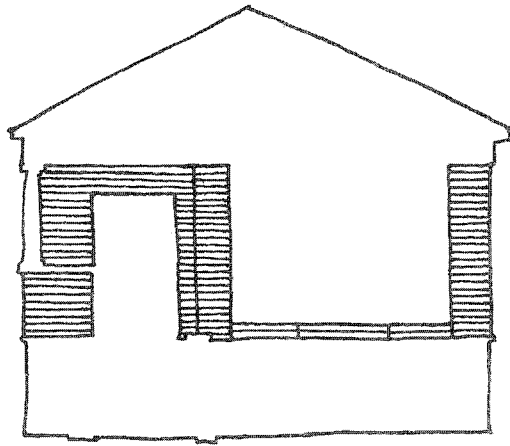

THE BODY. GENERALLY CONSIDERED THE BASIC COLOR OF THE HOUSE, THE BODY MAY HAVE A SURPRISINGLY SMALL SURFACE AREA ON THE STREETSIDE FACADE. IN THE NEOCLASSIC ROW-HOUSE EXAMPLE, WHITE OR A LIGHT COLOR WILL EMPHASIZE THE HORIZONTAL SHADOW PATTERN INTENDED BY THE NARROW SIDING.

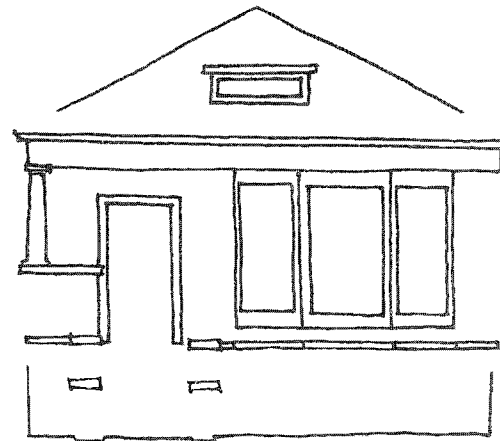

THE TRIM. TRIMWORK RECEIVES THE SECOND COLOR IN A TWO-COLOR PAINT SCHEME. OFF-WHITE OR LIGHT-COLORED TRIM GOES WITH THE ATTRACTIVE DEEP EARTH TONES. WHEN LIGHT COLORS ARE USED FOR THE BODY, A DARKER VARIANT OF THE BODY COLOR WORKS WELL FOR TRIM.

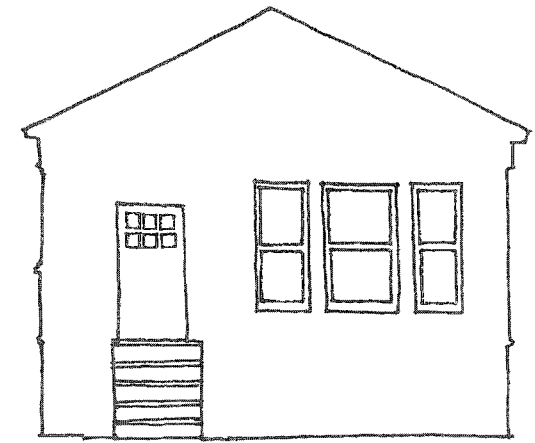

OPPORTUNITIES FOR MORE COLOR ARE PRESENTED BY WINDOWS, DOORS AND STAIRS. MOVING WINDOW PARTS ARE BEST PAINTED WHITE OR BLACK. WHITE IS PLEASANT SEEN FROM THE INTERIOR AS IT REFLECTS LIGHT INSIDE. STAIRS AND PORCHES ARE TREATED WITH SPECIAL HEAVY-DUTY PAINTS, OFTEN IN A NEUTRAL GRAY. DOORS CAN BE A BRIGHT SPOT, BUT UNLESS YOUR HOUSE IS NEUTRAL (GRAY OR WHITE), PICK A COLOR THAT HARMONIZES WITH BODY AND TRIM.

two-color scheme, paint the base, body and moving parts of the windows a single light or muted color, and the trim a compatible darker shade. The third option is always a single color for all parts, and once again a light or muted color is the safest choice.

Do not use extremely bright, pure colors, the kind that detergent advertisements describe as "reddest red, greenest green, bluest blue." They're fine for laundry, but disastrous for architecture.

Dark colors are used to advantage to make small areas more intense. For expansive walls, deep earth

tones are acceptable because they visually reinforce the feeling of structural stability. Dark colors are also useful as a field for limited amounts of ornamentation painted off-white. There are as many off-whites as there are colors. The one to select for trim is an extremely light tint of the basic hue used on the body of the house. Do not pick a dark color for a single-color paint job.

Light colors do justice to large planes, like the side of a stucco bungalow, because the color reduces the massiveness of the wall. Pastels are tints of pure hues, and are popular in warm climates because they absorb less heat and are cool to look at. The

widespread use of pastels on stucco buildings is one reason Oakland has been called "A Mediterranean City." Among pastels, do not use lavender or aqua. While light colors are the safest choice, by the same token they are often the duller. Do not be shy about the use of contrast to enliven a "blah" facade.

White paint is the best selection for formal building styles whose walls are visually contained around

the edges. The clapboard walls on Colonial Revival styles are contained by architectural features: the pilasters on the sides, and the pediment on top. The smooth stucco walls on Mediterranean houses are capped by a change in texture, the rough terra cotta of the red tile roof. Both styles look best painted a crisp white.

Contrast is created when dark and light colors are used together, and it certainly perks up a paint job when used in a limited way. Window moldings and doors are good opportunities. If contrast is misused, the parts of the facade separate into independent elements, instead of cooperating for a unified picture. If the proportion of light and dark planes are equal, the surfaces seem to advance and recede at will. If contrast is misapplied to ornamentation, the building looks as if it is wrapped in bands, or branded.

A better way to define the form of protuberant parts than contrasting colors is to rely on a **light background to display the shadows**. That is one reason why the clapboard siding on Colonial Revival houses looks best painted white. The profile of the overlapping boards creates a shadow line that is an intentional foil for the building's box shape.

Dangerous **combinations to avoid** are the use of warm and cold colors together, like red and blue, and the use of two colors of the same intensity, like the lights in a traffic signal.

Some highly ornamented Victorian houses are lavished with custom paint jobs in four or five, even six colors, applied in topographic fashion. Although this drama may be an unwarranted extravagance in your budget, the better examples demonstrate how hue, tone and value are used to highlight the architectural features in a unified way. Take a ride by the Camron-Stanford House, 1426 Lakeside, Mayor Wilson's Law Office at Embarcadero Cove, or Neighborhood Housing Services, 1641 98th Avenue. Examples of the work of Karl Kardell, an Oakland painter who offers customized palettes for all house styles, can be seen at: 1835 E. 24th Street, 5920 Channing Way, 5730 Presley Way, and, in a matched pair, at the corner of 63d and Hillegass.

Notice that the lively effect is achieved, not with vivid colors, but by **careful manipulation of tints and shades**. For example, red and blue are used together, a combination that would normally clash if the hues were pure. Instead the blue has a dark value—it is almost ultramarine, and the red is actually terra-cotta, a muted earth tone. The subtle cream background pronounces the shadow of the projecting ornamentation and ties the palette together in sophisticated manner.

It is unreasonable to change the roof of the house just for the sake of color, but when the time comes for re-roofing, color is an important consideration. Charcoal gray is usually the best bet. The eye tends to disregard the roof and focus on the facade anyway, so select a neutral tone that contributes to a low profile.

WINDOWS

More mistakes are made in the rehabilitation of windows than any other part of the house. And because windows are so very important to the appearance of the house—they are the eye to its architectural soul, so to speak—a bad decision on the window has disastrous effects on the appearance of the entire building, and even the neighborhood.

Design

Operationally, there are three kinds of windows appropriate to Oakland house styles. The **double-hung window** opens with an up-and-down movement. It has an upper, outside sash that slides down, and a lower, inside sash that slides up, a

TYPES OF WOODFRAME WINDOWS

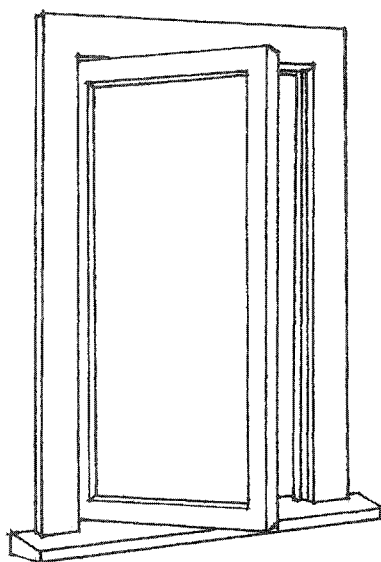

CASEMENT

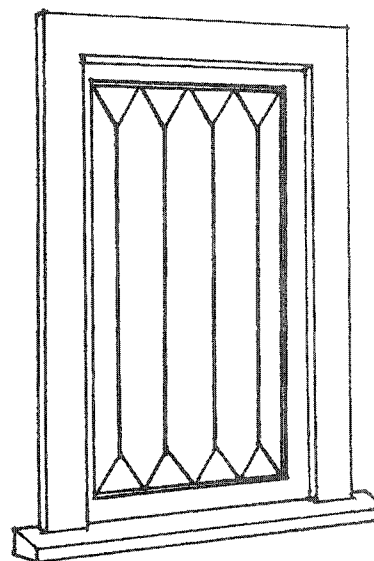

FIXED

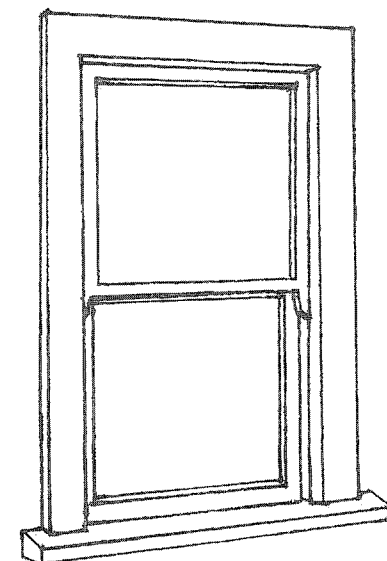

DOUBLE-HUNG

design that facilitates air circulation even when there is only one window in a room. The window movement is controlled by cord or chains on pulleys with weights, as illustrated, or by a more modern spring mechanism, concealed in the side jamb. Double-hung windows are always made of wood, and belong on Victorian and Colonial Revival houses, the Brown Shingle, Craftsman and California Bungalows. With age, double-hung windows are subject to poor fit, broken sash cords, and fouled pulleys. These bothersome defects are surprisingly simple to repair, and hardly justify the costly switch to an aluminum system just

to avoid the problem. All it takes is a hammer, screwdriver, chisel and patience. The Sunset book, *Basic Home Repairs*, offers instructions for correcting problems common to double-hung windows.

The casement window opens with an outward movement. It is attached to the frame by hinges along its vertical edge. Wood casement windows came into use with the Craftsman movement around 1905, and their popularity continued with the Prairie School and Period Revival. They seldom need repair beyond occasional tightening of loose hinges, and balky sliding rods. Steel casement windows, mass-produced for Wartime Tract houses,

are operated by a lever or worm gear, rather than manually like their wood predecessors. These gears sometimes require adjustment, and *Basic Home Repairs* explains how to do it.

The fixed window is a pane of glass enclosed in a rectangular or specially shaped wood frame that does not open. Like a movable window, its dimensions are carefully proportioned to the mass of the house and to the other features on the facade. Fixed windows, either plain or made of stained or leaded glass, are found on all styles. They pose few repair problems, although the leaded bars in leaded and stained glass may become bowed and require

DOUBLE-HUNG WINDOW: DO'S AND DON'T'S

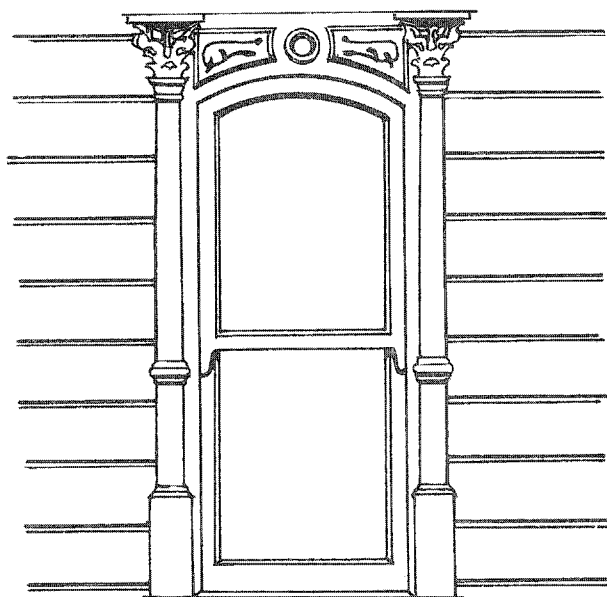

ORIGINAL DOUBLE-HUNG WINDOW (ITALIANATE).

DO LEAVE IT INTACT OR REPAIR OR REPLACE IN-KIND. WINDOWS ARE A KEY INTEGRAL PART OF THE ARCHITECTURE.

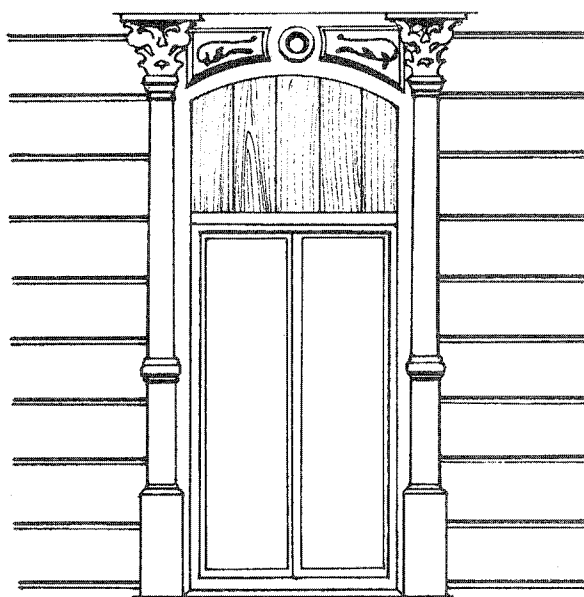

OPENING BLOCKED DOWN TO ACCEPT STOCK ALUMINUM FRAME.

DON'T DO THIS. IT LOOKS MAKESHIFT AND MARS THE PROPORTIONS AND APPEARANCE OF THE HOUSE.

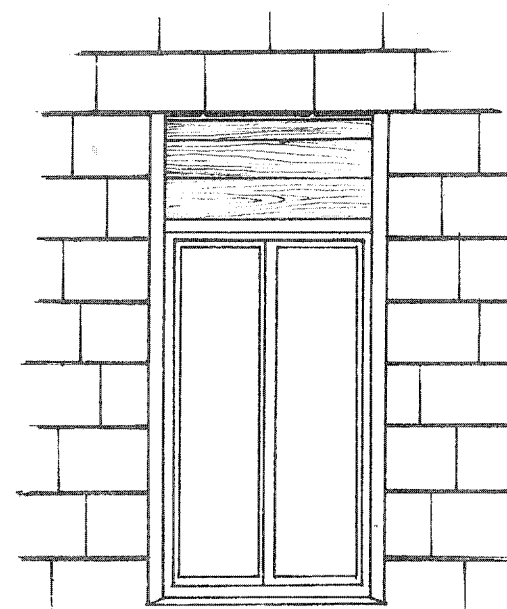

ORNAMENTATION REMOVED TO PUT ON ASBESTOS SHINGLES. NEVER DO THIS. TOTAL LOSS OF VISUAL INTEREST RESULTS.

PARTS OF A DOUBLE-HUNG WINDOW

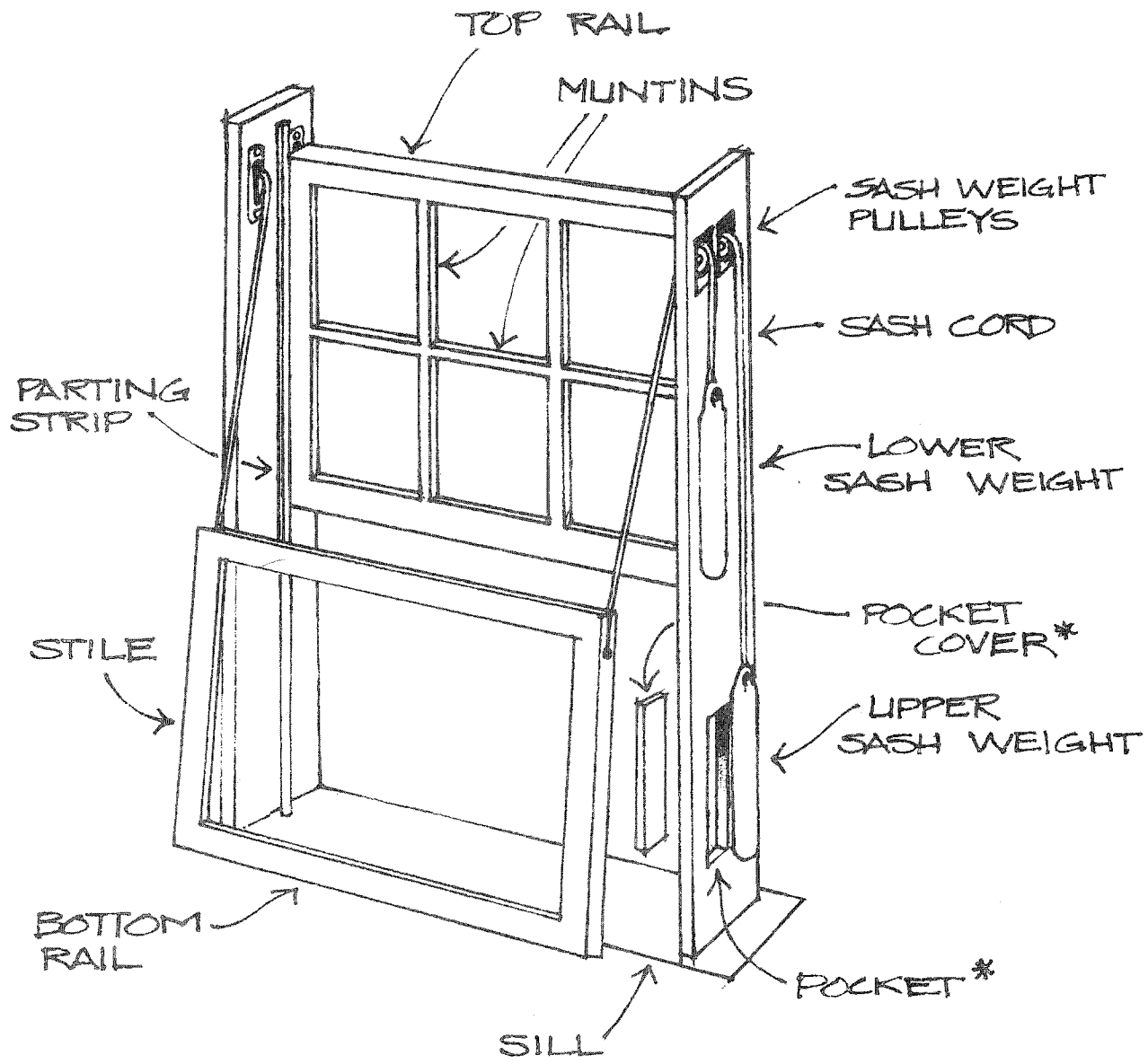

* NOT FOUND ON ALL DOUBLE-HUNG WINDOWS

DOUBLE-HUNG WINDOW FRAME DETAIL

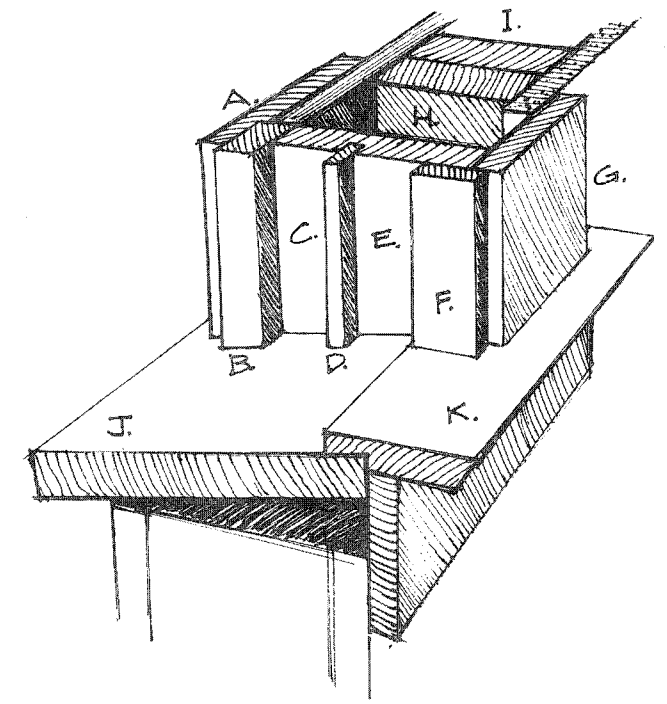

- A. OUTSIDE WINDOW FRAME
- B. BLIND (OUTSIDE) STOP
- C. UPPER SASH CHANNEL
- D. PARTING STRIP
- E. LOWER SASH CHANNEL
- F. INSIDE STOP
- G. INSIDE WINDOW FRAME
- H. CAVITY FOR SASH WEIGHTS
- I. STUDS
- J. WINDOW SILL
- K. STOOL

straightening. A Berkeley glazier, Margo Marsh, charges \$8 to \$12 per pane for repair, or consult the Yellow Pages under "Glass-Stained and Leaded." The New Renaissance Glass Works will provide instructions and materials to do-it-yourself, and the Oakland Office of Parks and Recreation conducts stained glass classes at Studio One.

Repair and Replacement

Two problems plague all three window types: broken glass and rotted wood frames. The technique for replacing window glass is illustrated in the section "Front Door."

Wood frames are subject to deterioration from years of use, from water accumulation, and from insects. Decay is evidenced by brown or black discoloration near joints or by rippling of the paint. Check the inside for water stains on the sash and sill resulting from condensation running down the glass. (Refer to the section "Porch: Wood Damage" for other danger signs of rot and termites.)

Four times out of five, the verdict to replace an entire window frame is due to a rotted sill only. Save the cost of replacement by repairing the sill in any one of several ways. The idea in all of them is to fill in the holes and provide drainage toward the outside.

- Use penetrating epoxy marine products, as described under "Wood Ornamentation." Git-Rot arrests the rot, and Marine-Tex is used to build up a slope that will drain. Follow directions on the label.
- For holes and cracks, use the carpenter's stand-bys. First, scrape away all loose material, then soak the sill with a penta product, like Wood Good, to kill the rot-causing organisms. Give it a day, then saturate the sill with linseed oil. Wait another day, and fill the cracks and holes with putty. A few days later, prime and paint it.
- For bad deterioration, use plastic wood, or its homemade counterpart, a paste of sawdust and waterproof glue, like Sear's resorcinol. Apply one or more coats, not more than ¼" at a time, letting it dry thoroughly between applications. Make

sure the new wood slopes toward the outside. Sand, prime, and paint.

- For irreparable deterioration, replace the sill entirely. Remove the old sill, being careful not to cut or chisel into the stool, which is the ledge on the room-side of the window frame. Use the old sill as a pattern for the new. Sand it, and bevel the edges slightly to ease installation. Anchor the sill to the window casing with brads, sinking the heads slightly below the surface of the wood. Putty the holes and seal with shellac. Caulk the joint between sill and frame. Finally, prime the wood and apply two coats of outdoor paint. (Refer to the illustration "How to Replace Door Threshold.")

If the entire window frame is rotted beyond repair, replace it with the same kind of window as the original. **Do not use aluminum frame windows.** Although they are less expensive than wood windows, they cause unbelievable harm to the appearance of the house. On any type of window, the pane of glass looks black when seen from a short distance, say across the street. On a wood window, the frame and trim are flat and broad, providing a visual transition between the glass and the siding. The aluminum window eliminates the valuable window frame; and substitutes instead a shiny filament of extruded metal. The result looks like a grotesque eye without eyelashes.

The shape of prefabricated aluminum windows is not the shape of the window openings on older houses. The Victorian Italianate, for example, was designed for a tall, narrow window. Because the standard aluminum product is not tall enough, the homeowner is forced to block down the window opening. To add insult to injury, this is usually done in a tacky manner, with a scrap of plywood or artificial siding. Similarly, the upper sash of Italianate windows is often curved or indented, and the rectangular aluminum frame just will not adapt.

Another visual problem with aluminum windows is the pattern of the panes. The division of window glass into panes is a conscious design decision integral to the architectural style of the house. On

Victorian houses, the double-hung window is the one-over-one style; on Colonial Revival, the six-over-one and eight-over-one arrangement is quite common. Aluminum frame windows do not offer this option, and in fact are designed just the opposite way. The window is divided vertically by a reflective metal strip, instead of being divided horizontally by a substantial wood muntin.

A functional problem of aluminum style windows is that they are not designed for optimum ventilation. With only a single, sidelong opening, the air does not circulate unless there is another open window across the room and a decent breeze. Even so, this can prove quite drafty. In contrast, double-hung windows are smartly designed so the top and bottom can be open at the same time. Without a draft, the warm, stale, room air rises and flows out the upper opening, while cool, fresh air is drawn in at the bottom.

If aluminum frame windows look so miserable on Oakland's older houses why are there so many of them? The answer is money. There is no arguing the fact that aluminum windows are cheaper to buy, but there is some debate about whether the saving is worth the value lost in the house's integrity and resale attraction.

Instead of looking at the price of an individual window replacement, evaluate the cost in the context of the total rehabilitation project. Say, for example, there are ten double-hung windows on a California Bungalow. Of these, eight are too rotted to repair, and two have broken sash cords. You are tempted to replace all ten with aluminum frames. Clear aluminum frame windows cost about 40% of the price of a comparable sized wood window, or a difference of about \$70 for a medium-sized window, so replacing all ten with aluminum instead of wood saves you \$700. Say your total rehabilitation budget is \$10,000. The \$700 is only 7% of the whole package, a fairly marginal difference economically considering the visual disaster it engenders. In the example, the right way to save money is to repair the sash cords on the two broken windows by yourself, instead of replacing them. Prices of comparative-sized windows are summarized in the adjoining chart.

WINDOW PRICES

WOOD WINDOWS	3' x 5'	3' x 4'
Double-Hung (one-over-one)		
Sash and Frame	\$86 - \$123	\$ 81 - \$132
Sash Only	\$39 - \$ 48	\$ 36 - \$ 44
Used sash	\$16 - \$ 20	\$ 12 - \$ 19
Caseмент (one next to one)		
Sash and Frame	\$97 - \$150	\$104 - \$145
Sash only	\$60 - \$ 85	\$ 51 - \$ 53
Used sash	\$16 - \$ 20	\$ 12 - \$ 19
ALUMINUM WINDOWS (Includes Screens)		
Single Hung		
Clear Aluminum	\$46 - \$ 57	\$ 37 - \$ 50
Bronze Anodized	\$56 - \$ 77	\$ 53 - \$ 68
Sliding		
Clear Aluminum	\$53 - \$ 69	\$ 35 - \$ 39
Bronze Anodized	\$72 - \$ 92	\$ 49 - \$ 59
Caseмент		
Clear Aluminum	Not readily available.	\$ 58
Bronze Anodized	Not readily available.	\$ 76

Notes on WINDOW PRICES:

1. Use this chart after evaluating the extent of damage to wood windows. In many cases, the frame is still in acceptable condition, or needs only a sill repair. Sash (the movable glass portion), can be purchased separately from the frame at window companies or salvage yards. The price of new wood sash is lower than the price of new aluminum windows.
2. Wood sash and frame show the greatest range in price because there are optional features available. When investigating, find out if the price includes any or all of the following: coil spring or spring balances, primer, screens, trim, or glazing.
3. The variety in prices shows that shopping around really pays off. Consult the *Yellow Pages* under "Windows—Wood" or "Windows—Metal." The price range indicated

here reflects a telephone survey of the following companies, (in alphabetical order):

- New Wood Windows:** Buckley Door Company, 1698 Evans Avenue, SF 282-2277
Griffin Lumber Company, 10944 San Pablo Avenue, El Cerrito 529-0234
Ocean Sash and Door Company, 3154-17th Street, SF 863-1256
Pella Window Planning Center, 185 Berry Street SF 543-1700
Truitt and White (Anderson Windowalls), 642 Hearst Street, Berkeley 841-0511
- Used Wood Windows:** Campanella Building Materials, 2700 E. 7th Street, Oakland 536-7002
- Aluminum Windows:** Barnes Glass Service, 14801 E. 14th Street, San Leandro 483-4036
Palco (Paramount Aluminum Company), 676-8th Street, Oakland 832-7282
Uneda Window Company, 4701 Grove Street, Oakland 655-1211

If you must use aluminum, there are compromises which can reduce its negative aspects to some degree.

- Keep wood windows on the front of the house. Replace side or backyard windows with aluminum. This keeps the street scene intact.
- Use anodized aluminum with an integral color, like bronze, or a baked on color, like white. This minimizes reflectivity, and also cuts down on pitting of the aluminum surface from salts in our marine environment. Anodized aluminum windows cost a third more per unit than clear.
- Leave wood window trim in place.
- Use single-hung aluminum windows because they resemble double hung wood windows. Never use the sliding type.

Stymie the temptation of aluminum windows by properly maintaining the wood frame windows you already have. Keep the joints caulked, the holes puttied, and the paint protective.

Energy

Heat loss and heat gain are likely to occur at the windows. Windows with southern exposures warm a space, while those facing north, rob warmth from it. **Three parts of the window contribute to heat transmission:**

- **Frame and sash.** Wood is a better insulator than metal so wood windows do not lose heat as rapidly as aluminum ones do.
- **Glass.** Conventional glass transmits heat rapidly. Double-glazed panes minimize heat transfer by about a half, but cost over twice as much as regular windows. Consider double-glazed glass for very large windows with exposure to extreme weather conditions, like a picture window that faces west and makes the living room unbearably hot in the summertime.
- **Leakage.** Air leaks between sash and frames, between the frame and the wall surface, and where the sash rails meet. Weatherstripping provides a tight seal, eliminating drafts, and its installation is quite simple.

DOUBLE-HUNG WINDOW WEATHERSTRIP PLACEMENT

THIS SKETCH ILLUSTRATES THE PLACEMENT OF SPRING-METAL WEATHERSTRIPPING, FOAM RUBBER AND VINYL TYPES ARE ALSO AVAILABLE.

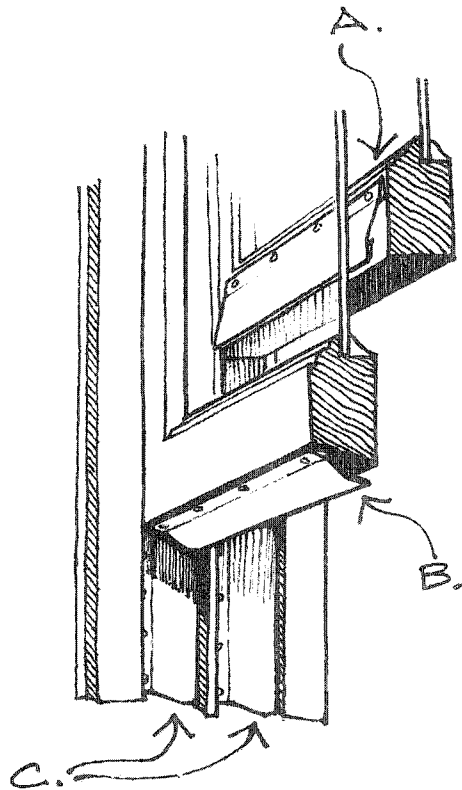

- A. INSIDE OF UPPER SASH BOTTOM RAIL (SEALS GAP BETWEEN TOP AND BOTTOM SASH WHEN WINDOW IS CLOSED)
- B. BOTTOM OF LOWER SASH
- C. SASH CHANNELS (DO NOT COVER PULLEYS)

Security

Aluminum windows are much less secure than wood frame windows. Aluminum windows fit so loosely in their frame that they can be removed completely by lifting the window up and pushing in. Wood frame windows can be safely secured with a key operated window lock. Manually operated locks are less effective because they are easily dispensed with by any intruder who is willing to break a small area of glass and reach in. If you are considering window bars, the *Oakland Housing Code* requires that bedroom window bars have a proven interior release mechanism for emergency exits.

WINDOW SECURITY: KEY LOCK FOR DOUBLE-HUNG WINDOWS

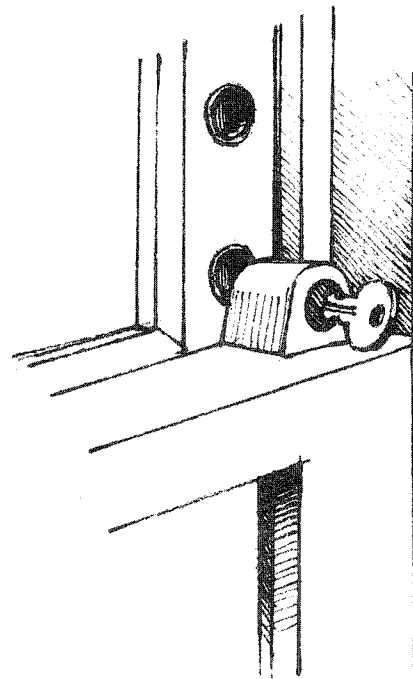

WINDOW SECURITY: VULNERABILITY OF ALUMINUM FRAMES

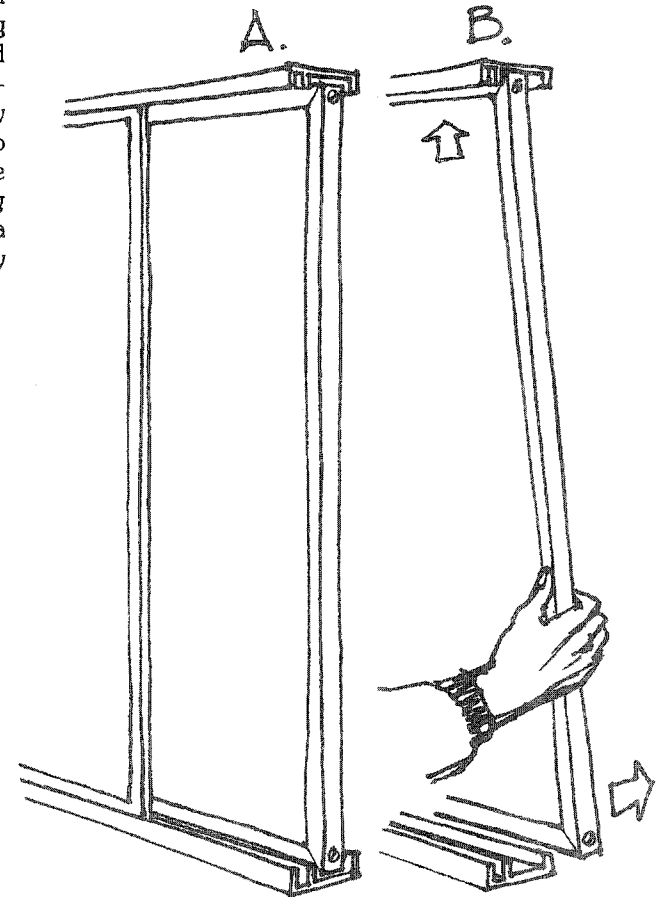

MANY ALUMINUM WINDOWS ARE SUBJECT TO EASY REMOVAL BY INTRUDERS. THE INSIDE (SLIDING) SASH FITS LOOSELY IN ITS TOP CHANNEL (A.) AND CAN BE REMOVED BY LIFTING UP WHILE PUSHING IN (B.)

ROOF

A leak-proof roof is essential to the longevity of the entire house. If water enters the building it will decay the wood structure and damage exterior siding and interior finishes. Roof repair is therefore one of the first steps in rehabilitation.

Roofing

Evaluate the condition of the roofing material by climbing a ladder, taking necessary safety precautions, and checking for:

- missing, broken, warped, or worn-out shingles or tiles on a pitched roof
- bubbles, separations, or cracking in the asphalt or roofing felt on a flat roof
- loose flashing, especially around chimney and valley
- sagging ridges
- protruding nail heads.

From the attic, examine the underside of the roof, looking for:

- rays of sunlight
- water stains on the rafters or roof sheathing
- sagging rafters.

Minor leaks in the roof can be repaired with an asphalt roofing compound and liquid roof coating. However, every roofing material has a finite life span, so when the roof starts to leak because of general material failure, it's time to install new roofing.

The selection of new roofing material should take visual and functional considerations into account. Functionally, the questions of durability, slope, fire resistance, and cost are important. The adjoining chart makes a comparison. Visually, the selection relates to the shape of the roof, the amount of roof surface seen from eye-level, and the material historically appropriate to the architectural style.

In addition to the home repair books mentioned elsewhere in this manual, an excellent source for

ROOFING MATERIALS

Material (In order of durability)	Minimum Slope (Change in vertical distance to change in horizontal distance)	Approximate roofing cost for 1500 square feet* (Cost per square foot in parenthesis)	Fire Rating
Slate	4" in 12"	\$10,000 (\$6.67)	Non-combustible
Copper	½" in 12"	\$6,600 (\$4.40)	Non-combustible
Ceramic Tile	4" in 12"	\$2,000 (\$1.34)	Non-combustible
Tar & Gravel	Flat	\$660 (\$.44)	Non-combustible
Asbestos Tile	5" in 12"	\$1,900 (\$1.27)	Non-combustible
Wood Shakes	3" to 6" in 12"	\$1,300 (\$.87)	Combustible
Wood Shingles	3" to 6" in 12"	\$1,300 (\$.87) If fire-rated: \$2,300 (\$1.53)	Combustible
Galvanized Steel	3" in 12"	\$1,400 (\$.93)	Non-combustible
Asphalt (composition shingles)	2" to 3" in 12"	\$600 (\$.40)	Non-combustible
Roll Roofing	2" to 3" in 12"	\$600 (\$.40)	Non-combustible

*These costs are very approximate and vary greatly, depending on the number of different roof surfaces, how they intersect, how accessible the roof is to workers, and the ever-changing price of materials and labor. They should be used to compare the relative cost of one material to another, not as accurate roofing costs for your house.

roof information is the *Roofers Handbook* by Craftsman Book Company, available at the Oakland Public Library.

If you are considering the addition of a skylight, the right time to install one (or more) is when the house is being re-roofed. For more information on skylights, one place to contact is B-B Plastics, Berkeley.

Vents

Moist, warm air rises to condense in the cooler attic space. **Proper ventilation of the attic is necessary to allow moisture to evaporate and prevent rot and structural damage to the rafters.** Locate and reactivate the original vents. The net area for the openings should be about 3% of the ceiling area of the room below. If the original vents are too small or are not arranged to permit adequate air circulation, additional vents may be added.

On architectural styles with an overhang—like Queen Anne, Colonial Revival, and Period Revival—vents under the soffit are easy to install, resistant to leaks, and well-camouflaged.

For buildings with no overhang and inadequate attic ventilation, consider a roof-mounted ventilator. This is a light metal duct with a cap on top which acts like a fan, when blown by the wind, and sucks air out of the attic. Prior to cutting the hole for installation, make sure the roofing is in good enough condition to be sealed up again. **Locate the roof ventilator so it will not be noticeable from the street,** and as far away as possible from the existing vent to insure air circulation. Paint the vent a neutral color with a matte finish.

Cutting new vent holes into a major facade of the house is the alternative with the greatest visual risk. Carefully consider the style of the house and locate the vent so it blends in with the other architectural features.

SOFFIT VENT

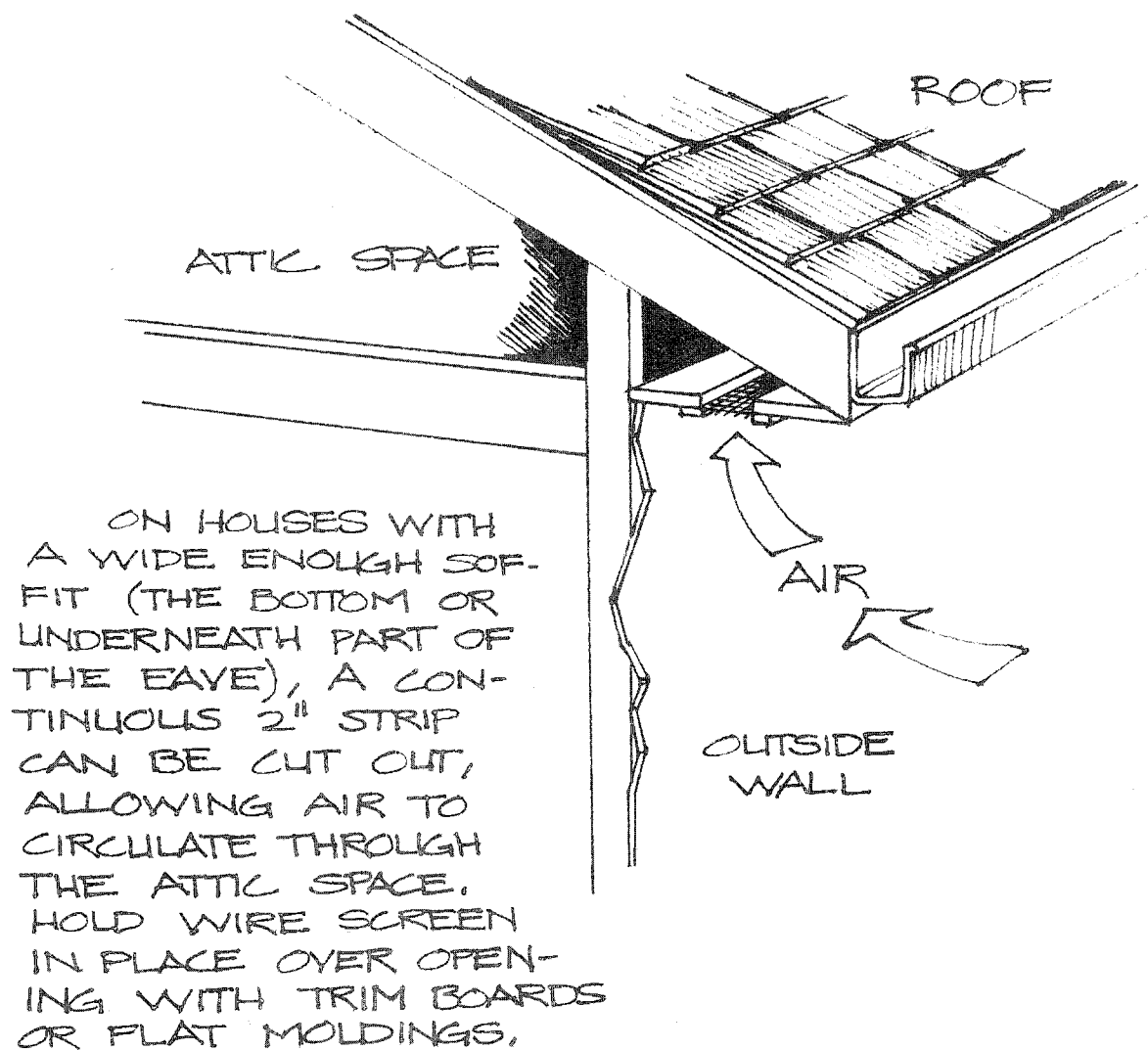

Flashing

Flashing is a strip of thin gauge sheet metal which prevents water from entering the building by covering the exposed joints and diverting the water to less vulnerable areas. Modern flashing is typically galvanized steel. On older buildings, the flashing was either copper, lead, terne-metal, or zinc alloy. It is often badly deteriorated, rusted through, or missing altogether. This is an obvious source of serious leakage and should be corrected early in the rehabilitation process.

Flashing is found at:

- roof valleys, ridges, hips, and changes in pitch
- eaves, gutters, and parapets
- door and window openings
- expansion joints
- the juncture of building and porch
- vertical projections through the roof, like skylights, vent pipes, chimneys and dormers
- the meeting of building and ground.

At vertical projections, two pieces of flashing are required: the base flashing which keeps water away from the joint, and a cap-or counter-flashing which keeps water from sneaking behind the base flashing. Only one piece of flashing is required for valley, ridge, eave, window and door locations.

To repair small holes in flashing, cut a piece of sheet metal 1" larger than the hole on all sides. Coat the hole and immediate area with roof cement. Apply the sheet metal to the hole and press for several minutes.

If the holes are widespread, or the flashing is generally deteriorated, replace it. Consult the *Reader's Digest Complete Do-it-yourself Manual* for instructions. When installing flashing, be certain that all the nails and clips are the same or a compatible metal with the flashing, or galvanic action will result. When dissimilar metals are in contact, a chemical reaction occurs and causes the deterioration of one of the two metals. For galvanized steel flashing, use zinc-coated fasteners.

On houses with a parapet wall, be certain the flashing extends at least 12" up the parapet, since this

PORCH ROOF FLASHING

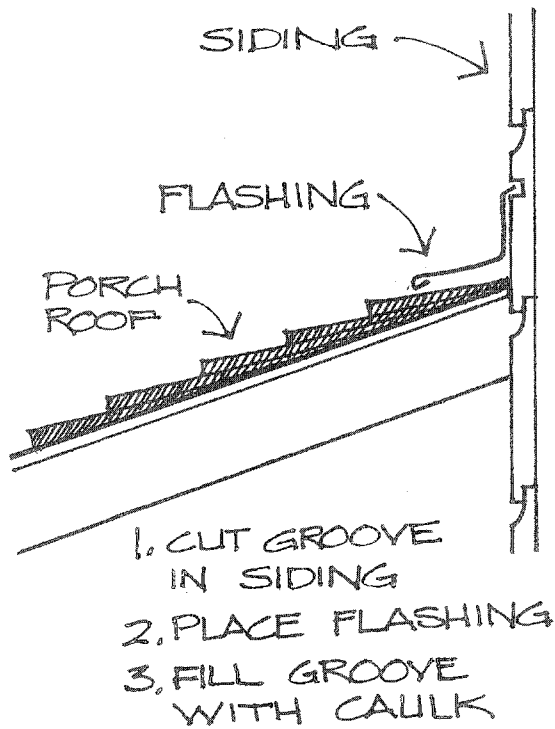

VALLEY FLASHING

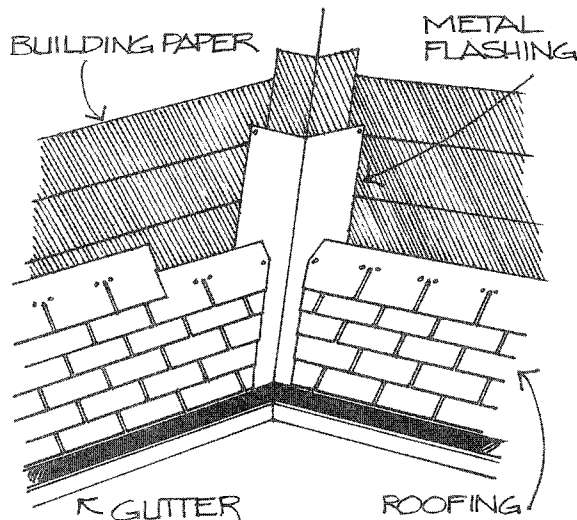

area is very susceptible to water accumulation from clogged gutters. On houses with a front porch roof, be sure there is adequate flashing to protect the vulnerable joint between porch roof and house siding.

Gutters and Downspouts

Gutters collect the water that drains off the roof and direct it to the downspouts. Victorian, Colonial Revival, and some First Bay Tradition houses were equipped with gutters made of redwood. They often had a decorative shape, and became a part of the ornamentation. If the redwood gutter has rotted, but the decay is limited, repair is feasible. With a sharp tool, scrape out the rotted material until solid wood is reached, and fill the scar with wood putty. You could also try the marine products described in the section on ornamentation. If the rot is more serious but localized, it is possible to remove the bad segment and splice in a new piece to match. Localized rot is common around downspouts or at joints between gutter sections. If the rot is widespread, a new gutter is necessary. One place to find redwood gutters is at Blackman Lumber, Oakland. The 4" x 4" size costs \$1.15 a lineal foot.

Wood gutters should be painted every three years. On the inside, use two coats of asphalt roof paint thinned to a brushing consistency with one part thinner to four parts paint. On the outside, use two coats of appropriate house paint.

Galvanized gutters are available at almost any building supply store, and cost \$2.77 for a 10' section of the 4" size. Reduce the offensive glare of the metal, and help it to harmonize with the architectural style by painting it with a neutral matte finish. Rust-free aluminum gutters with a baked-on white finish are available at Montgomery Ward at \$4.99 for a 10' section. Whichever material you select, **choose a gutter shape that relates to the original design in size and cross-section** for better water control and optimum appearance.

Queen Anne houses with towers pose the special problem of curved gutters. Because of the difficulty of replacement, it is not unusual to see towers with partial gutters only, and the deteriorated ornamentation and structure that result. Curved gutters are

GOOD AND BAD DOWNSPOUT LOCATIONS



THE HOUSE ON THE LEFT HAS A DOWNSPOUT LOCATED ON THE SIDE, FAR ENOUGH BACK TO AVOID INTERFERENCE WITH THE PORTICO. THIS IS A GOOD SOLUTION.

THE HOUSE ON THE RIGHT HAS TWO DOWNSPOUT PROBLEMS. A DOWNSPOUT INTERRUPTS THE VISUALLY IMPORTANT STREET FACADE, DIVIDING IT IN TWO. ALSO, IT IS PAINTED A CONTRASTING COLOR, EMPHASIZING THE DIVISION.

custom-made out of sheetmetal for about \$7 a linear foot by gutter and downspout contractors. Consult the Yellow Pages under that heading.

Many Brown Shingle houses and Craftsman Bungalows were built without gutters at all. This can cause soil erosion below the roof overhang, and premature blistering of paint on the wall that faces the prevailing wind. If these problems evidence, consider adding gutters that are sympathetic to the architectural style.

Check downspouts for leaks, especially at joints, at the gutter connection, and anywhere the downspout is not vertical. If the downspout empties directly onto the ground, place splashblocks at the outflow to break the fall of the water and minimize

DRIP STRIP

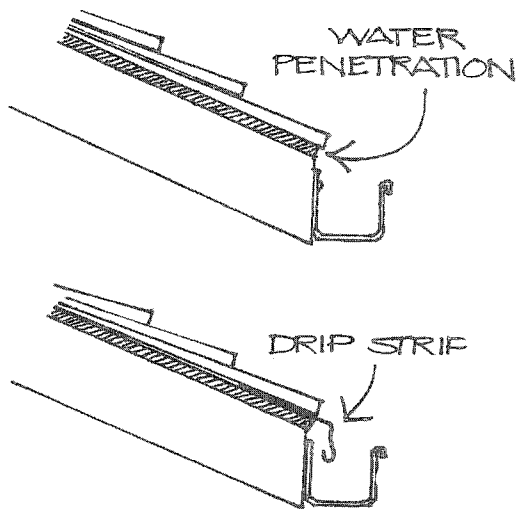

CAPILLARY ACTION CAN DRAW WATER BETWEEN SHINGLES AND SHEATHING CAUSING DAMAGE TO BOTH. INSERTION OF A DRIP STRIP PREVENTS THIS WATER DAMAGE.

erosion around the foundation. Use brick, stone, or a pre-cast concrete product, and slope it away from the house. The downspout must not be connected to sewer hoppers or sanitary sewer systems.

When adding a downspout, locate it as inconspicuously as possible, and paint it the same color as the wall behind. The corner, side and back of the building offer much better camouflage than the face. On the other hand, Bernard Maybeck, the most famous Bay Area architect of the Craftsman period, designed custom downspouts as a positive feature of the facade, demonstrating that functionalism and good architecture are inseparable.

Eave, Fascia, and Soffit

The eave, fascia, and soffit, all found at the upper perimeter of the building, are parts of the roof structure that are capitalized upon for their ornamental opportunities. Made of wood on Oakland houses, they are subject to rot from faulty gutters, leaking roofs, poor design, and deferred maintenance. If, for example, the gutters become clogged with leaves, overflow will soak the fascia. If the situation persists, the fascia, soffit moldings and rafter ends may decay.

Water is prone to penetrate the eaves at the edge of the roofing. To prevent this, install a metal drip strip between the roof sheathing and the roofing material, as illustrated. A 10' length of metal nosing costs \$1.15.

Brown Shingle style houses and Craftsman Bungalows have rafters and brackets which extend well beyond the roof and are normally left unpainted. As water rolls off the gutter-less roof onto the exposed rafters, rot is encouraged. The end grain is the most susceptible spot of all. Inspect the end of the beam to evaluate the extent of damage. (Refer to the section on wood porches for the signs of decay.) If damage is very limited, remove the tip of the rafter. If the rot has permeated the whole piece, graft on a new section, as illustrated in the section on repair of Brown Shingle style porches. Be sure to protect the end grain of all rafters, new or old, with a clear sealer.

MAYBECK DOWNSPOUT

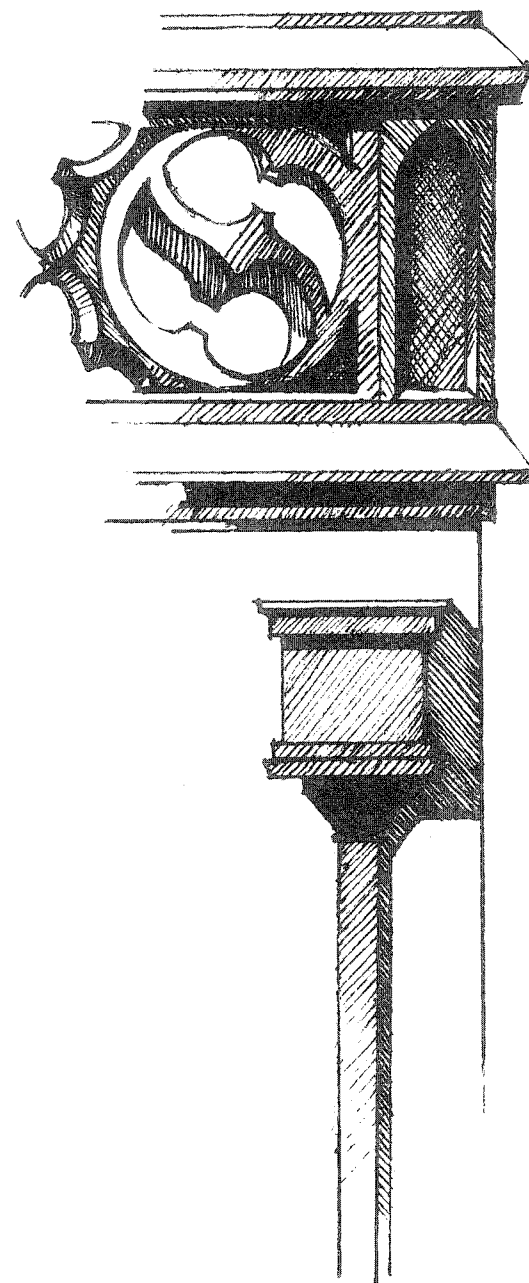

Chimney

The chimney was originally built to match the architectural style of the house, and its character should be respected when improvements are made. Italianate chimneys are straight shafts, with simple corbelling at the top. Corbels are cantilevered tiers that look like upside-down steps. Queen Anne chimneys show more variety in shape, with terra-cotta inlay and extensive corbelling. Colonial Revival chimneys are plain and square, while Craftsman chimneys used clinker brick, with the

very top course corbelled out.

Brick chimneys are subject to the same problems of aging mortar and structural cracks as brick foundations. Refer to that section for the danger signs, repair techniques and design criteria. **Unpainted brick should never be painted.** If you are advised that a coating is necessary for structural reasons, use a sealer with a clear finish.

Chimneys are a potential earthquake hazard because bricks tend to pull away from each other and the structure may collapse. If this is a worry, see a

contractor about tying the chimney into the floor and roof framing with metal straps to brace the structure. If the chimney projects well above the roof, ask about a series of steel angle-braces to provide additional support.

For instructions on returning the inside of an old chimney to working order, consult the May, 1977 issue of *The Old-House Journal*, available at the Oakland Public Library. Also refer to the section on fireplaces in Chapter 5. 

Chapter 5.

INTERIORS

FLOORS

Floors receive an enormous amount of wear and tear. When you set out to improve the floors, make the job last as long as possible by using good materials and careful workmanship.

Subfloor

The subfloor provides a rough base for the finish floor. In all REHAB RIGHT house styles except the Wartime Tract, the subfloor is supported by the joists. The oldest type of subfloor consists of wood planks nailed perpendicular to the joists. Beginning in the 1920's, diagonal sheathing was installed at a 45° angle to the joists, instead. Recently, plywood sheets have been used as the subfloor.

The subfloor rarely needs attention. However, as wood dries with age, the joists may sag and members of the subfloor may shrink. The loose fit results in squeaks underfoot. To correct squeaks, consult *Sunset Basic Home Repairs* or the *Reader's Digest Complete Do-it-yourself Manual* for the appropriate technique. The other problem with subfloors is just the opposite of dried wood: rot due to excessive water. This occurs primarily in the kitchen near the sink and in the bathroom near bathtub and toilet. The symptoms can be seen in the finished floor: buckling, discoloration, or a spongy texture.

When replacing the subfloor, always locate and correct the cause of the problem prior to replacing the damaged wood. Make sure that the thickness of the new wood matches the old, as the standard dimensions of lumber have been reduced

over the years. Gaining access to the subfloor requires careful removal of the finish floor and the baseboard, lest these exposed features suffer additional and unnecessary damage. If the subfloor of an entire room requires replacement, plywood is a good selection. It offers low-labor installation costs, resistance to squeaks, and great strength in earthquakes.

In Wartime Tract houses, the subfloor is the very same concrete slab used as the on-grade foundation. Repairs to the subfloor, therefore, consist primarily of patching concrete that has broken due to uneven settlement. A host of chemical products are available to make concrete repair fairly routine. Ask the hardware salesperson which is the best product for the problem you have: emulsified epoxy concrete, epoxy concrete, vinyl patching compound, or latex patch. Consult the home repair books mentioned above for tips on handling these materials.

Finish Floor

The finish floor is the floor you walk on. Unlike the rough subfloor concealed beneath it, the finish floor is a formal part of the room, so the original flooring was intentionally selected to match the interior space. Many Victorian houses do not have finish floors because wall-to-wall carpeting was installed directly over the subfloor. Beginning in the 1890's, finish floor was made of wood in standardized strips, odd-lot planks, or checkerboard parquet. Hardwood was typically reserved for living room and dining room; softwood was used for bedrooms, pantries, and the second story. Since the introduction of resilient floor covering, dozens of synthetic products have been developed and are available both in sheet and tile form. In new tract developments, the Victorian practice of expeditiously attaching wall-to-wall carpeting directly to the subfloor in lieu of a finish floor has been revived. This absence of finish floor in modern houses is one reason why the finish floor in older houses is a distinctive asset worthy of protection and display.

Hardwood Floor

A hardwood floor is one of the most valuable sales items a house can have. Check the real estate listing

in the Sunday paper, and you'll see how eagerly hardwood floors are announced as a special bonus. The image of luxury is well deserved. A handsomely finished oak floor lends an air of dignity to a room, a feeling of warmth, and indisputable character. **It is destructive to paint a hardwood floor, and wasteful to cover it with carpeting, yet both techniques are common remodelling shortcuts.** Usually the only thing cut short is the quality of the final appearance. **Hardwood floors should be repaired as necessary, and refinished to reveal the natural grain.** Then, if a softer surface is desired, area rugs can be placed on top, to complement the resource instead of hiding it.

TYPES OF STRIP FLOORING

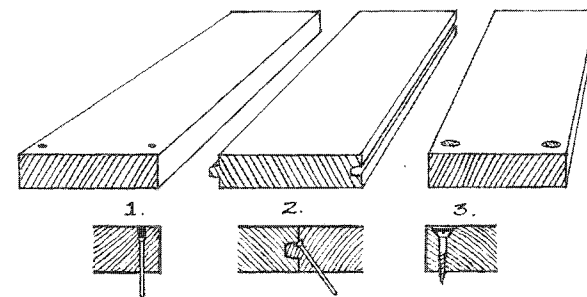

1. COUNTERSUNK FINISH NAILS IN FACE OF BOARD, HOLES FILLED WITH PUTTY,
2. TONGUE & GROOVE BOARDS "BLIND NAILED" THROUGH THE TONGUE OF EACH BOARD.
3. COUNTERSUNK SCREWS WITH HARDWOOD PLUGS

In Oakland, hardwood floors are typically made of oak strips. Although dimensions vary considerably, the 2" wide by 5/16" thick size is quite common. The way the sides of the strips are milled determines how the pieces fit together and how they are attached to the subfloor. Strips with a square edge butt up flush against one another, and are secured to the subfloor with facenails or screws. The pattern of nailheads or screw plugs is part of the design of the floor. Likewise, subtle variations in tone and grain in the wood itself contribute to the appeal of

PARTS OF A FLOOR

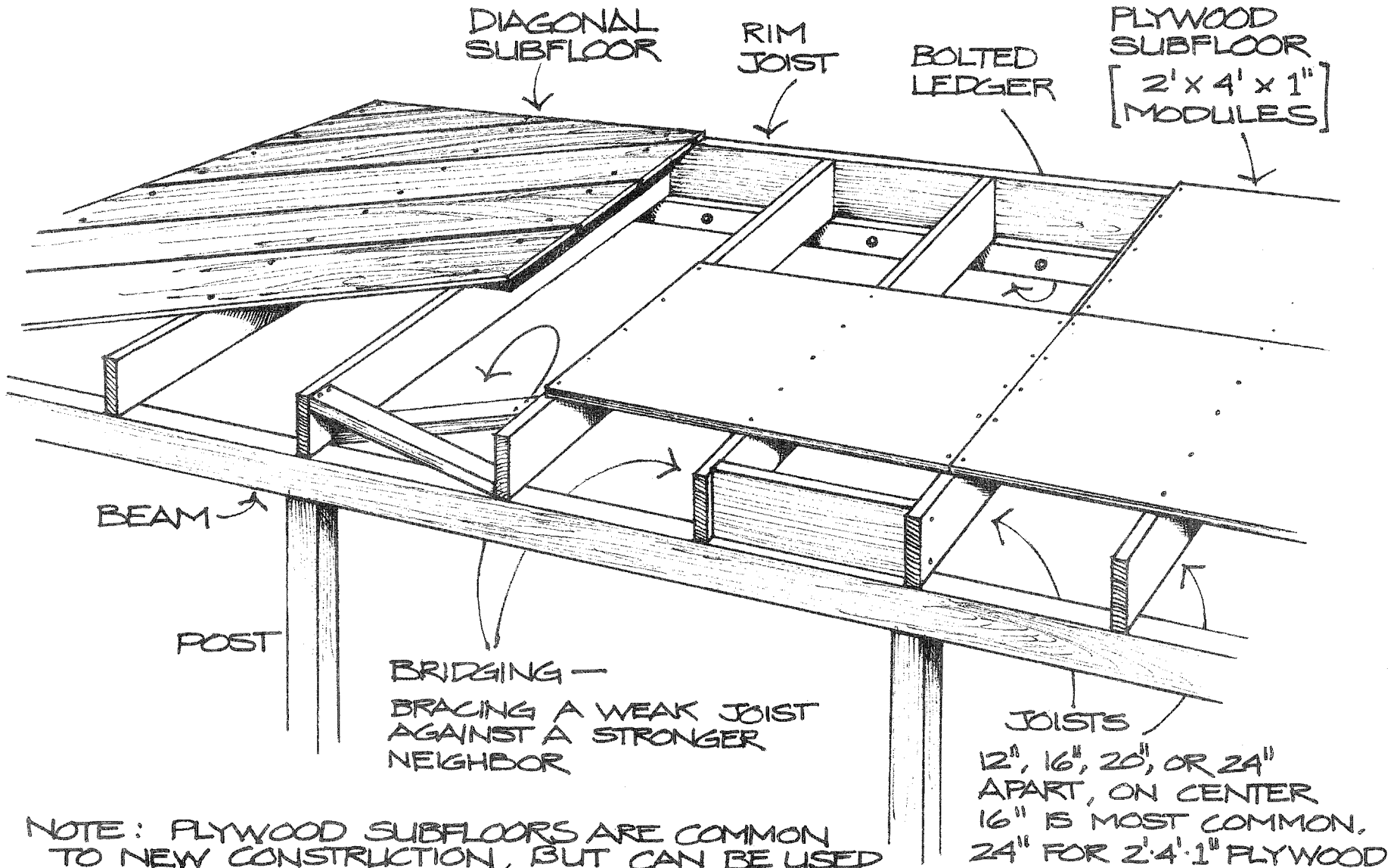

NOTE: PLYWOOD SUBFLOORS ARE COMMON TO NEW CONSTRUCTION, BUT CAN BE USED AS REPLACEMENT FLOORING IN REHAB (CUT TO FIT EXISTING JOISTS) OR FOR A NEW ADDITION. MANY OLDER HOUSES HAVE NO BRIDGING. IT CAN BE ADDED WHERE NEEDED FOR EXTRA BRACING.

the natural texture. Tongue-and-groove strips are inserted one into the next, and fastened to the subfloor with a blind nail through the tongue.

Repair. Hardwood floors are remarkably durable, but unfortunately they are not invincible. Damaged wood requires that the boards be repaired or replaced prior to refinishing the surface. Always correct the cause of the damage before making the improvement. The following problems can be easily repaired:

- **Loose boards** can be knocked, nailed, or screwed back into place if they are not too badly buckled or warped. Squeaks let you know where the trouble spot is.
- **Water stains** darken hardwood. After eliminating the source of the moisture, a leaky radiator or a potted plant perhaps, the stains can be bleached with a solution of oxalic acid and warm water. Oxalic acid crystals are available without prescription at Longs Drug on Fruitvale Avenue in two ounce bottles for \$1.22. Brush the solution on the stain and let it soak into the wood. When it dries, vacuum the crystals and sand the surface by hand or with an orbital sander. If you plan to sand the entire floor anyway, leave the bleaching until you see how much of a stain remains after the major sanding operation.
- **Protruding nails** should be tapped back into the board with a nail set. Otherwise they will chew up the belt on the drum sander, or create a toe-stubbing hazard.
- **Cracks between floorboards** are only an occasional problem in Oakland compared to the East Coast where the extreme range of temperature combined with high humidity causes floorboards to shrink so dramatically that gaping, drafty spaces are left in between. As the moisture content increases, wood expands, but when abutting floor boards allow no room for expansion, the wood is put into compression and shrinks instead. When dry again, the board is reduced to less than its original width due to the compressive stress. The best way to prevent cracks between first floor boards is with an adequate vapor barrier in the crawl space. (Refer to Chapter 4,

FIXING SQUEAKY FLOORS

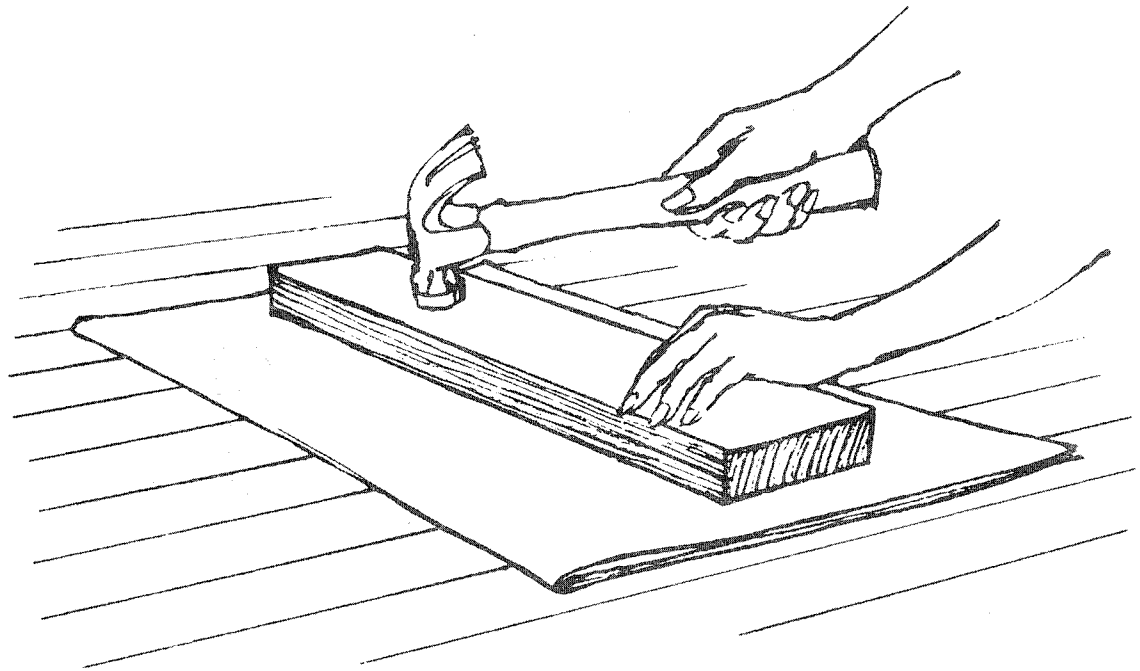

SQUEAKING FLOORS RESULTING FROM LOOSE STRIPS OF FLOORING MAY BE QUIETED BY TAPPING A SHORT LENGTH OF 2x4 (UNDERLAYED WITH NEWSPAPER & PLACED PERPENDICULAR TO THE DIRECTION OF THE FLOORING) WITH A HAMMER. MOVE THE BLOCK IN A SPIRAL PATTERN, CLOSING IN ON THE APPARENT SOURCE OF THE SQUEAK. KEEP THE BOARD ALWAYS AT RIGHT ANGLES TO THE FLOORING. TAP FIRMLY WITHOUT POUNDING.

“Crawl Space.”) Once the cracks have appeared, they can be filled-in with wood putty, sawdust and glue, or wood splines, but because these materials are rigid, and do not adapt to swelling and shrinking of the wood, they may only prove a temporary solution. Felt weather stripping, a more flexible material, can be forced neatly into cracks with a broad blade knife, and responds to dimensional changes in width of the wood.

Replace. The following problems require replacement of the damaged or missing wood with boards to match the rest of the floor:

- severe warp or buckling
- bad nicks or deep scars
- urine stains
- hole left where outmoded floor furnace was removed
- border design interrupted or missing pieces of inlay.

The technique for removing damaged boards and installing the substitutes is discussed in detail in the *Readers Digest Complete Do-it-yourself Manual* and *Sunset Basic Home Repair*. An electric hand drill is required.

Replacement boards may be available right in the house. Check closet floors, or the portion of an upstairs room where the wall intersects a peaked ceiling and the floor extends onto the eaves. These inconspicuous areas make willing donors. Occasionally salvage yards handle hardwood floor, but the most convenient source is to buy the boards new. At Blackman Lumber, butt end oak floor boards, 2" x 5/16", cost 20¢ running foot. Floorboards of more unusual dimensions can be found in stock at MacBeath Hardwoods. Also try Golden State Flooring in Brisbane, the supplier many floor contractors use, in the course of comparative shopping. The cost of replacing a few boards will demonstrate the monetary value of the entire floor, and why the investment to refinish it is worthwhile.

Refinish. After the floor is thoroughly repaired, and after all work is completed on the walls and ceiling of a room, it's time to refinish the floor surface.

REMEDIES FOR LOOSE FLOORBOARDS

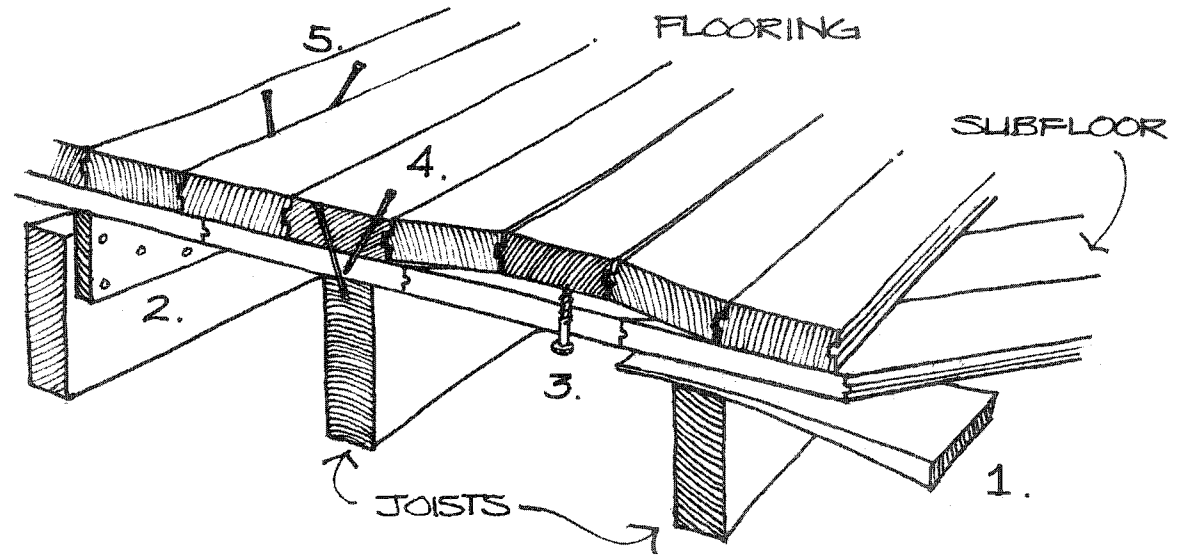

SUBFLOOR

1. IF JUST ONE OR TWO BOARDS ARE LOOSE, WEDGE A SHINGLE BETWEEN THEM AND THE JOIST.
2. IF SEVERAL BOARDS ARE LOOSE, BRACE A 1x4 AGAINST THE SUBFLOOR AND NAIL TO THE JOIST.

FINISH FLOOR

3. LOOSE FINISH FLOORING CAN BE TIGHTENED THROUGH THE SUBFLOOR WITH WOODSCREWS.
4. IF THERE IS A JOIST UNDER A SQUEAKY FLOORBOARD, ANGLE RIBBED FLOORING NAILS INTO JOIST. DRILL PILOT HOLES FIRST.
5. BETWEEN JOISTS, DRIVE 6d FINISH NAILS AT SLIGHTLY OPPOSING ANGLES INTO THE FLOORBOARD CRACKS CENTERED OVER THE SQUEAK, SPACE NAILS ABOUT 6" APART.

Otherwise loose plaster, splattered paint, or dropped tools can be disastrous. During the rehab process, protect the hardwood floor with an old carpet pad and a drop cloth in order to avert unnecessary, additional damage.

A dull finish that does not require a complete overhaul can be rejuvenated with mineral spirits or turpentine. Rub out rough spots with fine steel wool, and use paper towels to distribute and absorb the liquid. **Complete refinishing involves: sanding down the uppermost layer of the wood for a smooth surface, applying a stain if a change of color is appropriate, and applying a protective coat of oil or plastic to arm the wood against wear.**

To prepare for sanding remove all furniture from the room, as well as any drapes or other surfaces which can trap fine dust. Otherwise the waylaid dust may drift back on to the floor while the final sealer is drying and ruin the hard-won smooth surface. Close doors to adjoining rooms and halls in order to contain the dust, and seal them with 2" wide masking tape. Keep windows open for adequate ventilation. (Here's where double-hung windows really pay off.)

Power sanders are used to remove the old finish and smooth the surface. A drum sander is used for the center of the room; an edger is used around the perimeter where the floor meets the walls. They are available at A-Arrow Rents and Sales at \$18 a day for the pair, plus \$1.35 per belt and 35¢ per disc. An easy-to-follow instruction booklet is included free-of-charge. An average room can be completely sanded in a day by two hard workers.

Sanding is done by making several passes across the floor in different directions. A typical sequence is:

First cut—A coarse sand-paper to break up the old finish. (Grit size: 2½ - 1½)

Second cut—A medium sand-paper to remove scratch marks left by the coarse paper. (Grit size: 1 - 0)

Third cut—A fine sand-paper to remove scratches left by the medium paper and to leave the floor perfectly smooth. (Grit size: 2/0 - 5/0)

For more detailed information, a helpful booklet on sanding and refinishing techniques can be ordered for 10¢ from Pierce and Stevens Chemical Corporation, P.O. Box 1092, Buffalo, New York 14240. Or, consult a home repair manual.

Be attentive to the following:

1. Oak strips that were 5/16" to start with do not allow much leeway for sanding, especially if they've been sanded before. One way to recognize 5/16" boards is by the facenails which are nailed 7" apart. Likewise, tongue and groove floorboards are ruined if they should be sanded down to the tongue. If in doubt, remove a board and see how much "floor" you have left. Also note how much allowance there is between the top of the board and the nailhead.
2. The fine dust that accumulates in the collector bags is highly combustible, and sparks are liable to be sucked up into the bag during the sanding operation. All collector bags should be emptied into boxes or cans and placed outside where they can do no harm should a smoldering spark ignite.
3. Drum sanders draw a lot of current, so make sure when you rent one that the voltage required by the machine matches the output available in your house. A heavy-duty extension cord and a 3-prong plug adapter may be necessary.
4. A drum sander has strength and even a mind of its own, like an automated robot. It takes physical will to control one. To avoid serious damage, never let the sander rest in one place for even a fraction of a second or it will grind a crater in the middle of the floor.
5. If you removed linoleum in order to get at the hardwood, additional steps are needed to clean off the mastic and paste before sanding begins. (Refer to the section on linoleum floor.)
6. Clean-up after sanding is critical to the success of the finish. Vacuum the floor, baseboards, window sills, bookshelves, and everything in the room that could possibly sequester dust.

After sanding, **the color of the floor can be left as is or made darker by use of stain.** Remember that

even a clear finish without stain will make the floor look darker than it does as raw wood. As this is difficult to envision, test it by spreading mineral spirits (benzine) or turpentine over several square feet. The wood will have about the same tone when wet as it will when finished. If you decide to use stain, don't forget that stain appears darker on a small sample than it will look on the floor. An overly colorful commercial stain can be diluted with turpentine for a more subtle effect, but keep a record of the proportions used, in case you run out between coats. Be certain that the stain you select is chemically compatible with the finish you have in mind. **Never use a varnish stain.** Instead of enunciating the grain, this product obscures it like a sheet of formica.

The next decision is a very important one: which finish to use. There are two basic types. The surface film type (shellac, varnish, quick-dry varnish, polyurethane) is a traffic tolerant coating on top of the floor. The penetrating type (penetrating sealer, oil) seeps into the wood, filling the spaces between the uppermost fibers. It offers the soft lustre associated with old wood floors, but not the abrasion resistance of surface film.

By and large, **the best wood floor finish for the average household is polyurethane.** Its advantages are: resistance to abrasion, easy maintenance, and the choice of gloss or satin sheen. Although at \$19.40 a gallon it is the most expensive of the floor finishes by a few dollars, it has the longest floor life of them all. For best results, apply the polyurethane in several thin coats, rather than a single thick one. Polyurethane is incompatible with certain stains, but generally oak and fir floors typical to Oakland's older houses look better without stain anyway. If you are undecided between satin and gloss, satin is recommended. It shows less dirt, and it offers the option of switching to gloss later on by waxing and buffing the polyurethane (which otherwise does not require waxing).

The Old-House Journal, a special interest periodical "published monthly for people who love old houses," is an excellent source for advice on refinishing floors. Much of the information offered here was derived from back issues dated February, May, July, December 1974, January 1975, and April

1977. The journal is available at the Oakland Public Library, main building and Rockridge Branch. (See Chapter 6, "Books.") In addition, *The Old-House Journal* maintains a special answering service for floor questions. Send a complete description of your refinishing problem with a self-addressed stamped envelope to: Refinishing Clinic, *The Old-House Journal*, 199 Berkeley Place, Brooklyn, N.Y. 11217.

If you are stymied by the time and skill involved, but are anxious for the results of a hardwood floor, you can hire a Flooring Contractor with a C-15 license issued by the State of California to do the work for you. Most offer free cost estimates. Make sure the estimate includes everything you want done, like boards replaced or nails countersunk, as well as the quality of materials and performance you deem satisfactory, like the number of sanding cuts, or the type of finish. Then make sure the estimate is firm.

For a complete refinishing job, flooring contractors charge about 90¢ to \$1.00 a square foot for small rooms, and about 75¢ a square foot for rooms larger than 500 square feet. Installing hardwood in the space left by the grill of a disconnected floor furnace, and feathering the edges so it does not look patchy, costs about \$40 for a 3' x 3' spot. This is a common situation in Craftsman and California Bungalows with FHA financing. (See "Utilities: Mechanical.")

Some flooring contractors might agree to let the homeowner do a portion of the job and reduce their prices accordingly. Persuasion may be difficult, however, because State law and professional reputation govern the quality of the completed product.

Softwood Floor

Softwood floors found in kitchens, pantries, bedrooms and second stories of older Oakland homes are typically made of tongue and groove Douglas fir strips, although pine boards and square edge joints are seen too. Unlike oak, softwood boards are as broad as 4" wide, and run right up to the wall without a border.

Fir may not appear promising to the uninitiated

eye, but it produces startlingly good results when refinished because for a "soft" wood it is very hard. The open grain is so pronounced you can actually feel it with your hand. This is a good way to differentiate fir from pine which is smooth to the touch. Also, fir is reddish when stripped, while pine is white to yellow. Pine is much softer than fir and does not refinish as successfully. Unfortunately, fir is often misidentified as pine.

Repair, replace, sand, stain, and finish a fir floor in the same way you would an oak floor, as described in the preceding section. Since the fir is a softwood, take extra care to sand delicately. Unless there is a heavy coat of paint to remove, start with a medium grade sandpaper. Try to limit the total number of cuts. Polyurethane is a good finish for softwood because it lends additional strength to the floor.

Ceramic Tile Floor

Ceramic tile is the original flooring for practically all bathrooms. The bathroom itself was introduced during the Victorian era, with the creation of a separate room for bathing instead of just a zinc tub in front of the fireplace. At first, the bathroom floors were softwood, splatter painted in five colors. But with the fashionable concern for hygiene at the turn of the century, tiles were quickly incorporated into bathroom floor and walls. Pastel tiles were not common until the 1920's.

Small, white hexagonal tiles are a distinctive asset in many Oakland houses dating from about 1910-1930, like California Bungalows. These tiles should never be replaced with modern square ones, but should be repeated in kind if repair or additions are needed. They are available at Tile Town in Oakland for \$2.49 a square foot. Usually, no special tools are needed for installation since their size makes them a flexible unit. "Spiral weave" tiles, 4 white hexagons with a black hexagon in the middle, can be ordered from Tile Distributors, 7 Kings Highway, New Rochelle, NY 10801. White hexagons were also typical to kitchen counters of the same houses. Give a remodeling job an air of authenticity by using the original tile selection in a modern context.

Quarry tile is the finish floor in the entry hall of some Mediterranean style houses. Replacements should always be in kind. Quarry tile is available at most tile stores in Oakland. Select a store that offers competent instruction and free loan of tools with a refundable deposit, if you are a novice.

Resilient Flooring

Resilient flooring is made of pliable materials such as vinyl, asphalt, linoleum, rubber, cork, and various synthetic compositions. It comes in tile or sheet form. When it is time to replace worn out linoleum, or when for maintenance purposes you have decided to switch to a resilient floor covering, no historical rules really apply, since the selections are all modern. Use the following design guidelines to aid in the selection of color, pattern and style.

The floor should provide a neutral background. Each of Oakland's older house styles has architectural features of interest in the kitchen. If you REHAB RIGHT, these should be the focus of attention, not the floor. Select a restrained solid color. Patterns make small rooms look smaller, and generally give the kitchen an unsettled feeling.

Resilient tiles are somewhat easier for an amateur to install than sheet vinyl, but the sheets offer better hygiene. There are no seams to collect dirt, and the edges can curve up the wall 3" or 4" for a coved base. While excellent where concealed under cabinets, **coved bases are highly inappropriate when they cover up shoe molding** or when it looks as if the floor is climbing up the wall. Along these boundaries, install the sheet vinyl flat so it abuts the wall in the same manner as a tile would.

For a finished edge where the resilient flooring meets the wall, use an ample strip of wood molding. (Refer to the section "Walls: Trim.") Do not use the thin metal strip more commonly associated with modern floor covering. The metal strip looks shiny and skimpy in a location where something with a subdued finish and substantial mass is appropriate.

The most difficult rehab problem associated with resilient floor covering is its removal in order to refinish the wood floor underneath, like in a bedroom. Good advice on removal techniques can be found

SHEET VINYL: DO'S AND DON'T'S

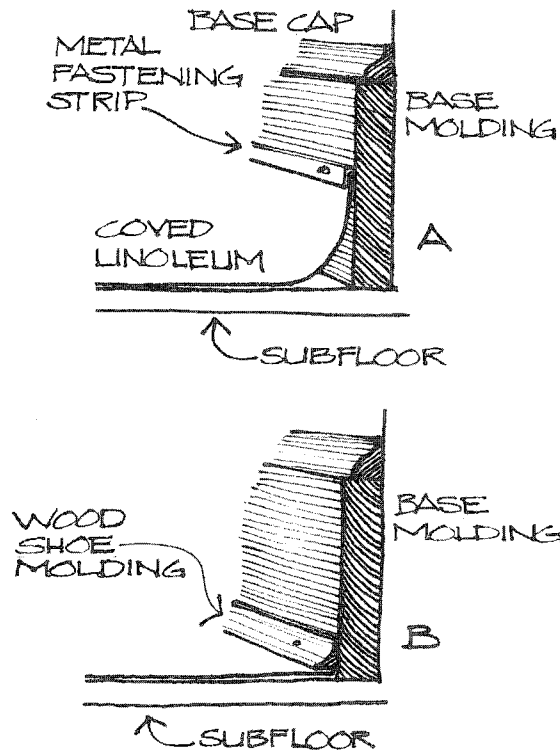

AVOID THE SITUATION SHOWN IN "A" ABOVE WHERE LINOLEUM OR VINYL FLOORING "CLIMBS THE WALL", HALF-HIDES THE SUBSTANTIAL BASEBOARD AND GIVES UNDUE PROMINENCE TO THE INCONGRUOUS METAL STRIP. IF "A" EXISTS, CORRECT IT BY CUTTING THE FLOORING ALONG THE MIDPOINT OF THE CURVE WITH A LINOLEUM KNIFE. HOLD THE EDGE FLAT WITH COVE OR QUARTER-ROUND WOOD MOLDING, AS SHOWN IN "B". USE THIS METHOD FOR NEW FLOORING AS WELL.

in the January 1977 issue of *The Old House Journal*.

WALLS

Walls are more than the flat sides of a box. They have three dimensions of their own. The quality of the wall surface, the quantity of trim, and the proportion of blank surface to shapely ornamentation all determine the character of a room. If the rehabilitated wall treatment is consistent with the original design of the house, then the room will be interesting to look at and comfortable to be in. If the original treatment of the wall is disregarded, the room can become incredibly boring and cold.

Plaster

Plaster is the universal wall surface for old houses in Oakland. It provides a plain but not bland background to offset architectural details, like molding and beams. Plaster frequently needs repairs because it is a rigid material applied over a flexible framework. As the house settles, the wood members shift, including the lath strips nailed to the studs, but the plaster attached to the lath does not. Its recourse is to crack. Plaster is also prone to brown spots from leaky water, to chips from picture fasteners which pull away, and to holes from plumbing and electrical work.

The good news is that these mishaps are easily repaired by the amateur. Cracks and chips do not justify the expense or esthetic travesty of switching to another wall surface. Most home repair books include instructions on plaster repairs. An excellent reference is the four issue series in *The Old-House Journal*, December 1973 through March 1974. Note the similarity to the repair of stucco, as discussed in the chapter on exteriors. **Always correct the cause of plaster damage**, like leaky plumbing or rotted wood, **before repairing the plaster itself**.

Very large holes and extensive deterioration of a plaster wall call for complete re-plastering and the help of a plastering contractor. (See the *Yellow Pages* of the Oakland telephone directory.) The alternative and more modern solution to major

plaster problems is sheetrock. Gypsum board, another name for it, is like a solid sheet of plaster. It comes in 4' x 8' panels, in varying thicknesses. A ½" thick panel, for example, costs \$4.19. The installation of sheetrock, unlike the art of plastering, can be handled by the average handyperson.

Sheetrock should be used to fill in large areas where plaster is dilapidated, in consort with other architectural features appropriate to the room. Instead, sheetrock is often mistakenly used like panelling, projecting out from the wall and covering up or eliminating architectural details. When the job calls for sheetrock, do the following:

1. Carefully remove any molding, cornice work, or other trim from the wall area where plaster will be replaced by sheetrock, and store it safely aside. (See "Walls: Trim.") It may be possible to leave the shoe molding in place if the plaster can be cut below the top of the molding and the sheetrock installed behind it.
2. Pull off the bad plaster and its lath back to the studs. As with many demolition jobs involved in rehab, it doesn't take much skill to rip something out, just time and aggression. This is a dusty operation, so remove all furniture and drapes from the room, close the doors, sealing the cracks with 2" wide masking tape, and open the windows. Wear an inexpensive fibre mask and, at the end of the work day, sweep and vacuum the dust that settles.
3. Install the sheetrock so that it fits into the space once filled by plaster. It should not make the wall any thicker than it was. Think of sheetrock as solid plaster, not as panelling.
4. If the surface texture of the sheetrock is not the same as the existing plaster, special spackling compounds are available so the sheetrock can be coated to match. Practice first on a scrap. Matching surface finishes is noteworthy in Period Revival houses where the plaster is heavily textured.
5. Replace the molding or trim in its original position on the wall. This is extremely important. Blank sheetrock walls look rather insipid; when combined with architectural features they are

PLASTER REPAIR

A. HAIRLINE CRACKS CAN BE FILLED WITH A THIN MIXTURE OF PATCHING PLASTER OR WALLBOARD JOINT CEMENT. RUB THE CRACK LIGHTLY WITH VERY COARSE SANDPAPER, THEN BRUSH OUT LOOSE MATERIAL, FORCE THE FILLER DEEP INTO CRACK WITH FINGERTIPS, THEN SMOOTH SURFACE WITH "V" STROKES OF A PUTTY KNIFE.

B. SMALL CRACKS SHOULD BE OPENED AND UNDERCUT WITH A SPECIAL TOOL OR A CAN OPENER. THIS PREVENTS THE CRACK FROM REAPPEARING AFTER FILLING AND PAINTING.

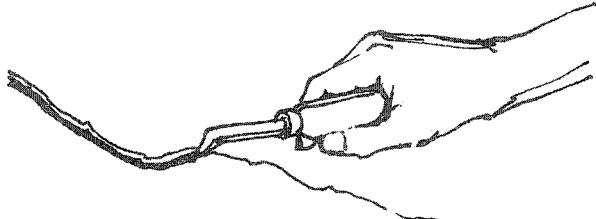

CLEAN OUT LOOSE MATERIAL FROM CRACK. FORCE FILLER DEEP INTO CRACK FROM 2 DIRECTIONS, THEN LEVEL SURFACE WITH "V" STROKES.

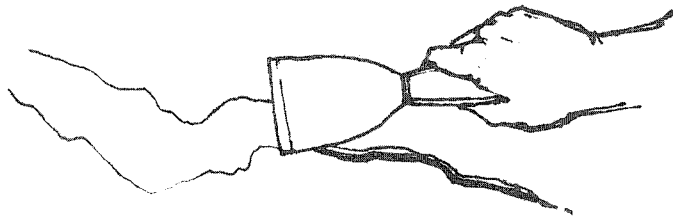

C. WIDE CRACKS AND HOLES LARGER THAN A FEW INCHES IN DIAMETER SHOULD BE FILLED WITH 3 LAYERS OF PATCHING PLASTER. UNDERCUT THE EDGES OF THE HOLE OR CRACK BACK TO THE LATH, MAKING SURE THAT THE LATH IS FIRMLY ANCHORED TO THE STUDS. (IF NOT, OR IF THERE IS WATER DAMAGE, SEE ILLUSTRATION ON EXTENSIVE REPAIR.) DAMPEN CRACK WITH SPONGE. ADD FILLER TO HALF THE DEPTH OF THE CRACK, SCORE THE FILLER COAT WITH COMB OR PUTTY KNIFE, THEN ALLOW TO DRY. BRING 2ND COAT TO WITHIN $\frac{1}{8}$ " OF THE WALL SURFACE. LET DRY, APPLY FINAL COAT WITH TROWEL OR WIDE-BLADED PUTTY KNIFE.

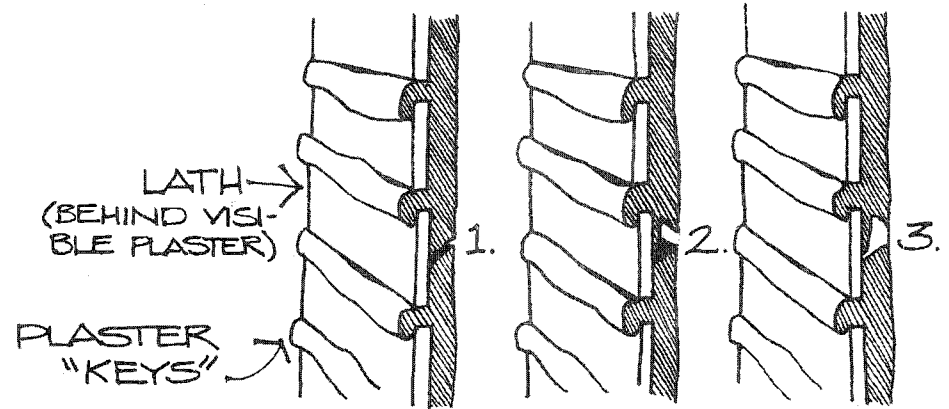

1. CRACK IN PLASTER
2. CRACK OPENED & UNDERCUT
3. FILLING COMPLETE

EXTENSIVE PLASTER REPAIR

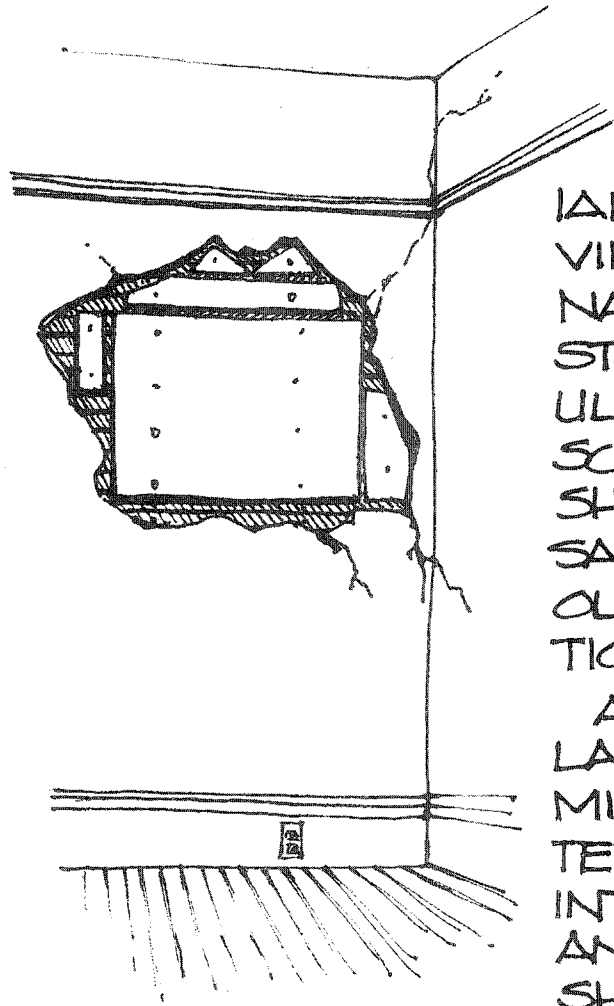

WHEN AN EXTENSIVE SECTION OF PLASTER IS LOOSE OR CRUMBLY, PULL THE LOOSE MATERIAL OFF THE WALL, SAVING LATH IF POSSIBLE. NAIL SHEETROCK TO STUDS, FILLING IRREGULAR GAPS WITH SMALL SCRAPS NAILED TO LATH. SHEETROCK SHOULD BE SAME THICKNESS AS OLD PLASTER OR A FRACTION LESS.

APPLY TWO OR MORE LAYERS OF THICKLY-MIXED PATCHING PLASTER, PRESSING FIRMLY INTO CRACKS AND LATH AND STOPPING JUST SHY OF THE ORIGINAL THICKNESS. LEVEL PATCH WITH A FINAL THIN COAT OF PLASTER.

SHEETROCK: DO'S AND DON'T'S

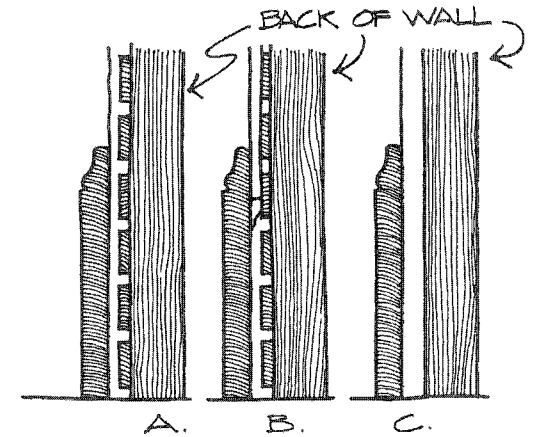

CORRECT

- A. ORIGINAL PLASTER AND BASE MOLDING.
- B. THIN SHEETROCK OVER ORIGINAL LATH, INSERTED BEHIND OLD MOLDING (CLEAR OUT PLASTER BEHIND TOP OF MOLDING FIRST).
- C. THICKER SHEETROCK DIRECTLY ON STUDS. MOLDING CAREFULLY FRIED OFF, THEN PUT BACK OVER SHEETROCK.

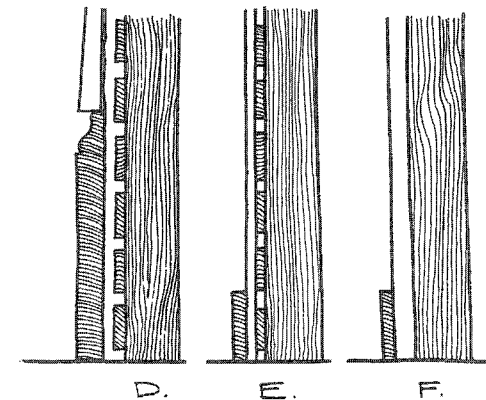

INCORRECT

- D. SHEETROCK ON TOP OF PLASTER.
- E & F. SHEETROCK APPLIED CORRECTLY, BUT ORIGINAL MOLDING DISCARDED FOR SKIMPY NEW MOLDING.

WAINSCOT STYLES AND VOCABULARY

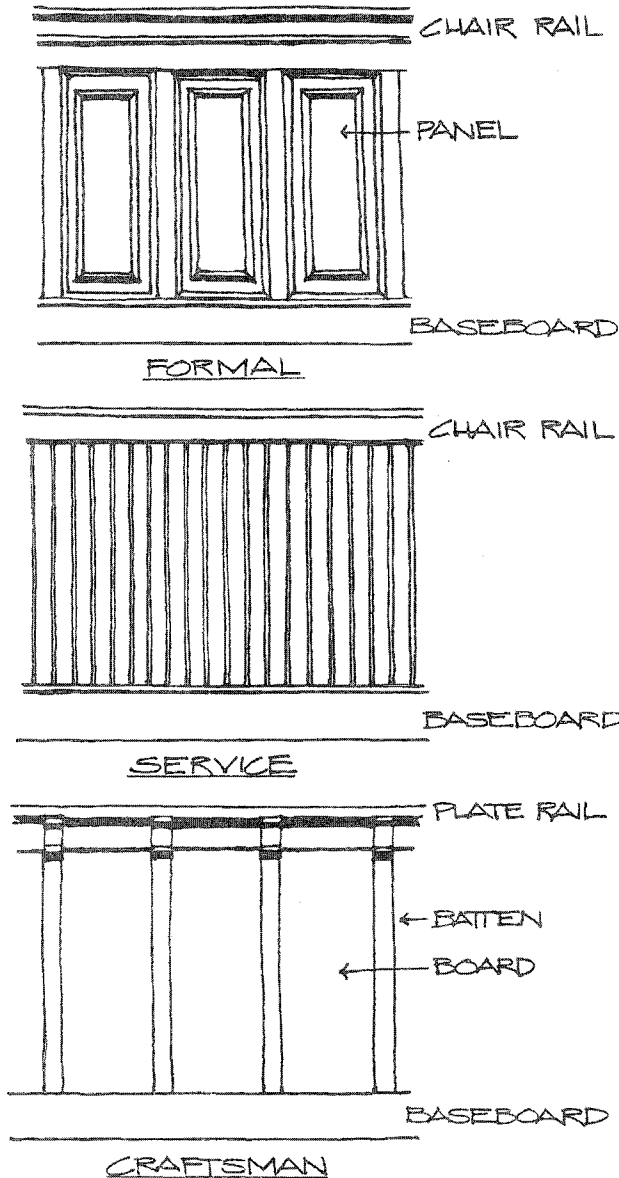

suddenly meaningful. This is particularly noticeable in Victorian houses with high ceilings. An uninterrupted expanse of sheetrock on a wall 10' or 12' high can resemble a drive-in movie screen if the trim is not returned to its rightful place. (Refer to the section "Walls: Trim.")

Wood

Judging by the walls of modern tract homes, you'd never know that wood is a wall surfacing material. Yet in older houses, **wood walls and interior features** are quite common. In fact, they are one of **the main reasons these vintage residences feel so warm and welcoming inside.**

A skirt of wood on the lower 3' to 4' of the wall is called wainscotting, and the design varies with the architectural style, as illustrated. Other wood architectural features inside include ceiling beams, archways, columns, platerails, and moldings. The concept of preservation and the technique of restoration described here for wood wall surfacing applies equally to these features. (Refer also to the section "Walls: Trim.")

If wainscotting is still in place, leave it in place. If the wainscotting has been removed, it can be recreated, as shown, and interest returned to an otherwise defaced wall. Wainscotting can be ordered at Bartley Milling Co., Oakland.

If the wood wall surface is unpainted, by all means leave it that way. If it is a rare remaining example of graining—a 19th Century skill by which one wood was artfully painted to look like another—then too it should be left intact.

If the wainscotting has been painted, you can repaint it, strip and refinish it, or if the house is a Victorian, you can arrange to have it grained in the traditional manner. Three such craftsmen are Daryle Myers, John L. Seekamp and Nat Weinstein, all in San Francisco. In no case should original wood wall surface be "antiqued" or made to look old by a two-tone paint and glaze job. Absolutely shun the process called "distressing" by which wood is brutally marred with chains and hammers to simulate age and wear.

Existing wood work may require repair prior to re-

finishing. To replace damaged pieces, bring a sample to a big lumber yard that stocks a variety of interior finish lumber to match type, grain, size and stain. Redwood, fir and mahogany are fairly easy to find, but the gum wood so typical of Prairie School, Period Revival, and some turn-of-the-century houses is hard to find. A good substitute is birch. The grain of birch approximates the gum, and it is a light enough color to allow staining to match. If the original pieces are thicker than standard replacement stock, you may have to buy an even larger piece and have it cut to size. A less costly alternative suitable for camouflaged locations is to buy the thin standard piece and back it with inexpensive plywood until the thickness matches the original stock.

Refinished woodwork can make a dramatic improvement in the character of a room. However, **stripping is a tedious commitment that should be undertaken selectively and with forethought.** It is advisable to strip paint or varnish from woodwork when:

- the architectural style calls for natural wood.
- there's fine hardwood underneath, and you have the time and patience to do the job right. Delinquent specks of paint or haze of color negate the improvement. As with floors, hardwood was usually reserved for the formal rooms, and softwood used for the family rooms and service areas.
- there's softwood underneath, and stripping would make repainting easier and more effective because accumulated layers of paint are so thick that the detail of carving or molding has become obscured.
- there's softwood underneath, but the paint is so alligatored that stripping is more expedient than scraping.
- there's a varnish or shellac finish that has darkened unattractively with age and a fresh clear finish is desired.

The art of stripping and refinishing interior woodwork is a subject of much debate among energetic restorationists. The technique is similar to refinishing furniture, but offers the advantage of relatively flat surfaces, and a stationary surface to bear up

RE-CREATING A WAINSCOT

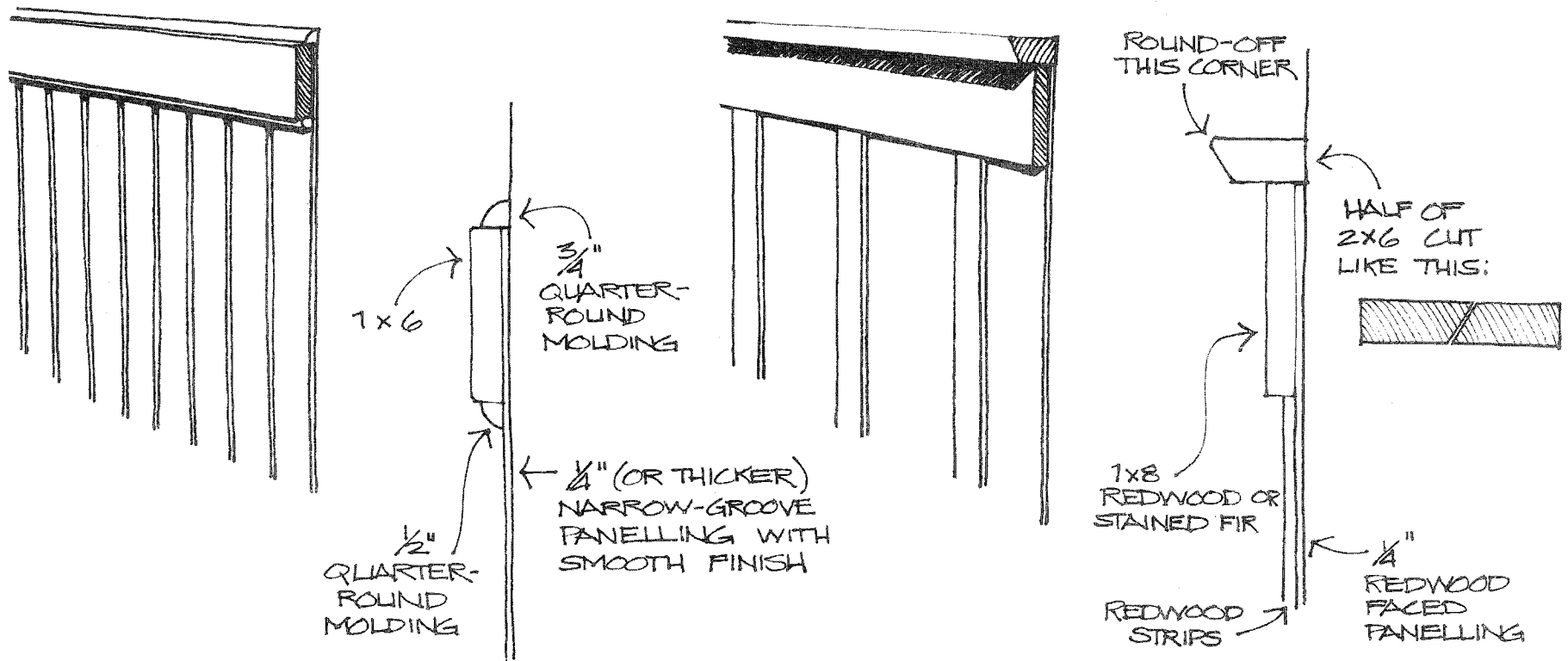

A. RECREATING A SERVICE STYLE WAINSCOT: CHOOSE A STRAIGHT-GRAINED WOOD PANELLING WITH REGULARLY SPACED GROOVES 2"-4" APART. IF PANELLING COMES IN 8' SHEETS, USE 4' SECTIONS TO SAVE WOOD. PLACE SECTIONS ABOVE BASEBOARD MOLDING AND NAIL TO STUDS. BUILD UP TOP MOLDING FROM QUARTER-ROUND MOLDINGS & 1x6 BOARDS, AS ILLUSTRATED. FILL NAIL HOLES, THEN STAIN MOLDING TO MATCH PANELLING. SEE SECTION ON PAINT STRIPPING FOR HINTS ON FINAL FINISH

B. RECREATING A CRAFTSMAN STYLE WAINSCOT: NAIL HALF SHEETS (4'x4') OF SMOOTH-FINISH REDWOOD FACED PANELLING ABOVE BASEBOARD, WITH GRAIN POINTING VERTICALLY. CUT 2x6 LUMBER IN HALF LENGTHWISE AT A 60° ANGLE (YOU WILL NEED A CIRCULAR SAW FOR THIS) AND BUILD TOP MOLDING AND PLATE RAIL AS ILLUSTRATED. PLACE SMOOTH-SANDED STRIPS OF WELL DRIED REDWOOD LATH (BUY 6" LATH AND CUT INTO 3" STRIPS) AT 1 OR 2 FOOT INTERVALS OVER PANELLING, COVERING JOINTS BETWEEN PANELS.

against without additional bracing. Stripping is unavoidably messy and either clouded by unpleasant fumes, or accompanied by a piercing noise. Familiarize yourself with the options described below. Choose your weapon, save up old newspapers, and be sure to ventilate the room.

Chemical removers are applied with a brush and left in place long enough to buckle the layers of unwanted paint so that they can be scraped off with a wide-bladed putty knife in a continuous ribbon. There are at least seven different types of compounds available for this purpose. The most appropriate to interior woodwork is a non-flammable heavy-bodied water rinsing remover. It is thick enough to hold on vertical or irregular surfaces and it contains methyl chloride to minimize the fire hazard. Typical brands are Zip-Strip and Jasco, available for about \$12 a gallon.

The most important rules for successful chemical stripping are:

- **Don't be stingy with materials.**
- **Let the remover sit for a long enough time to cut through all the paint.**

While most home repair books recommend stripping only a small area at a time, professionals do large sweeps (as much as 50 square feet) with great efficiency. This is advisable for the amateur once the knack is acquired. If any of the large soaked areas should dry out before you get there with the blade, wet it down again with more remover.

Heat removers are appliances that literally melt the paint away. Several kinds are available. A semi-enclosed electric coil, like the heating element on top of a stove, is available at Mark's Paint Spot for \$20.50. Or, it can be rented from the Alameda Rental Center for \$4 a day. Another type is the heat gun that resembles a blowdryer for hair, but is actually an industrial tool. It can be ordered via *The Old-House Journal* for \$56.90, including shipping. A propane blow torch should not be used for interior work due to the likelihood of scorching and the high fire hazard.

Another option combines **heat and chemicals**. Use a wallpaper steamer to accelerate the effect of a water-rinsable paint remover. Apply the stripping

compound, preferably one with a high methyl-chloride content, and let it sit for 15 minutes. Apply the steam through the pan of the steamer, moving it slowly across the wall, about a square foot a minute. Follow it with a wide-blade scraper, and four or five coats can be removed promptly with success. Do not use steam with chemical removers which contain carbon tetrachloride or benzene.

Manual stripping of woodwork involves more physical effort than heat or chemical methods. Nonetheless, health constraints, poor ventilation, or personal preference may preclude other methods, as nothing short of a gas mask can prevent some intake of the noxious fumes they engender. Also, successive layers of old, rock-hard enamel may not yield easily to chemicals. Manual scraping can cut through multiple paint layers and into the pristine wood lying below the paint impregnated outer wood fibers.

A hook-type scraper is the basic tool required. Get a 2½" bladed scraper for wide surfaces and fast cutting, plus another small enough to fit into the tightest spot you must deal with.

Here's the technique:

- **Use two hands** when you can. One hand pulls on the end of the handle, controlling speed and cutting angle while the other pushes on the blade end, controlling pressure. Determine the most efficient blade angle and use only as much force as necessary to conserve your energy.
- **Sharpen blades often** for easier, smoother scraping. Replacement blades are usually available, but most blades accept repeated sharpening with a fine-tooth flat file. When using the file, maintain the original bevel of the blade.
- **Scrape with the grain**, especially on woods with pronounced grain, like fir. Scraping across the grain or on the end grain will result in splintering and gouging (resort to coarse sandpaper here).
- **Wear earplugs and goggles**, and spare yourself. The sound of the manual scraper at work is a chilling, high-pitched vibration. Paint flecks scatter upward toward your face as you draw down on the tool.

Once the wood is stripped, a stain and/or a finish must be applied to protect the wood. **Stain selection is a matter of architectural style and interior decor.** The dark stains historically appropriate to Colonial Revival and some First Bay Tradition houses are truly sombre, and a slight divergence from accuracy may be warranted for modern taste.

For the finish, select among the film forming types (varnish, lacquer, and shellac) **and the oil types** (boiled linseed, Danish, and tung oil). The secret to using film finishes is to thin them. Thin coats dry faster and harder than thick coats, and a thin first coat seals the wood properly. Varnish is thinned with turpentine (4 parts varnish to 1 part turpentine); lacquer with lacquer thinner, and shellac with denatured alcohol. An old nylon stocking is a good applicator that leaves no bristle marks. Oils are typically applied with a piece of soft cotton, but for large surfaces a brush can be used if each of the three coats are very thin. Whichever finish you select, always work with the grain of the wood, and always allow plenty of drying time—usually 24 hours—between each application. Adequate ventilation is crucial when using these volatile fluids.

The Old-House Journal offers detailed advice on stripping woodwork. Refer especially to the issue dated January 1976 for the problem of paint specks and haze. For answers to specific questions, write to: Refinishing Clinic, *The Old-House Journal*, 199 Berkeley Place, Brooklyn N.Y. 11217. Enclose a stamped, self-addressed envelope. For free information on one particular line of refinishing products, send a self-addressed stamped envelope to: Frank Broadnax, P.O. Box 196, Ila, GA 30647.

Lincrusta-Walton

Lincrusta-Walton is a heavy, embossed cardboard wall covering, imported from England and Belgium in the late 19th Century as wainscot and wall covering for Victorian and Colonial Revival parlors and hallways. It came in large rolls and was soaked in water for several hours before installation. Unfinished, lincrusta-Walton is beige, but when in style,

it was usually coated with a glossy brown varnish. Subsequently, as Victorian taste lost favor, the modeled surface was made unintelligible by layers of paint.

A house that has lincrusta-Walton boasts a real antique. No longer commercially available, the original embossed cardboard is extremely valuable and should be retained and shown off. Patches deteriorated by water can be mended by making a plastic mold from an unharmed portion, and filling the mold with papier-maché compound. This ingenious technique was developed by Agnes Pritchard, plasterer, in association with San Francisco Victoriana. Complete instructions are available from that firm, or can be found reproduced in the October, 1975 issue of *The Old-House Journal*.

LINCRUSTA-WALTON

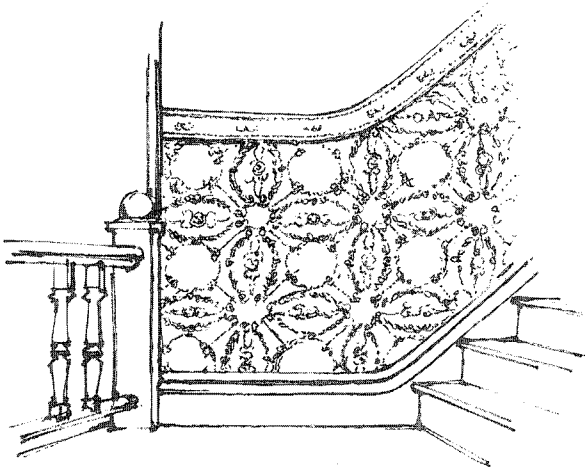

Panelling

Panelling is a modular wall surface which, with dubious thanks to modern technology, comes in an untold number of designs and offers an astounding range of natural and special effects. Panelling falls into three basic categories: (1) solid wood, (2) plywood with wood veneer (by far the most popular), and (3) non-wood, like polystyrene, plastic lami-

nates, fiberglass, hardboard, and cork. **Modern panelling was not the original wall surface for any of the architectural styles discussed in this book,** although a non-manufactured version of solid wood wall panels is found in some Victorians, Colonial Revival and First Bay Tradition houses.

Panelling is a gruesome mistake when it is used to cover up original architectural features that are still substantially intact. If, however, a wall in a less important room has been devastated by earlier misguided remodelling efforts, panelling can be an acceptable solution if certain guidelines are followed:

- Always use real wood products. Imitations look cheap even if they cost dearly.
- Select panelling with regular spacing between the vertical grooves. So-called "random" spacing looks contrived rather than interesting.
- Select a wood with color and grain sympathetic to the original architecture, as indicated by other features in the room.
- Avoid flamboyant grains, like birdseye maple or pecky cedar, that compete with original features in the room rather than working with them.

Panelling can also be used to recreate the proportions of long lost wainscoting, as illustrated previously.

Equally pertinent here is the removal of unwanted panelling in hopes of recapturing the original architectural character of a room. Panelling is either nailed to the studs, or glued in place with a contact cement. Some panels are additionally attached to each other with tongue-and-groove joints. Look for the nails hidden in the tongue or recessed in the v-groove.

To remove panelling, you'll need a pry bar, a hacksaw blade, and brute strength. Work the pry bar under the edges of each panel to loosen it. Cut nails you can reach with the hacksaw blade. Be prepared to make a complete renovation of the wall behind, as damage to the original plaster is almost certain. The most practical replacement is to install sheetrock against the studs, and reinstate the trim as needed.

CROSS-SECTION OF A PLYWOOD PANEL

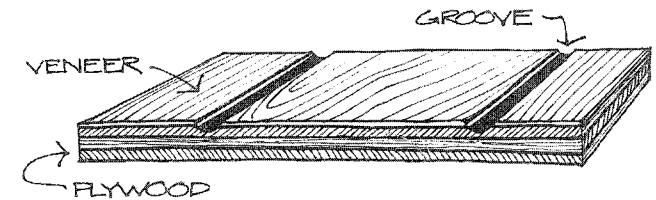

THIS SECTION OF STANDARD PANELLING IS EXAGGERATED IN THICKNESS TO SHOW THE PLYS (ACTUAL THICKNESS IS ABOUT 3/16"). GROOVES ARE CUT THROUGH THE WOOD OR VINYL VENEER INTO THE FIRST PLY. GROOVES ARE OFTEN STAINED DARK TO SIMULATE A SHADOWLINE BETWEEN "BOARDS". IF YOU USE PANELLING, CHOOSE STRAIGHT-GRAINED, REAL WOOD VENEER WITH EVENLY SPACED GROOVES.

Paint

Paint is properly applied to plaster, sheetrock and in some cases wood. The advent of latex paint has markedly simplified the painting process. Latex, a water-based as opposed to oil-based paint, thins with water, spreads easily, dries in about an hour, and has little or no paint odor. A full spectrum of colors and finishes is available.

Use a flat latex for walls and ceilings. Use semi-gloss latex enamel, also called satin finish, for trim, doors, shelving, woodwork, and kitchen or bathroom walls. An exciting new introduction by the Dutch Boy company is a flat latex enamel that is ideally suited to kitchen and bathroom walls because it is washable but not at all shiny. **Do not use high-gloss latex enamel.** It catches and reflects light in a distracting way and accentuates imperfections in the painted surface, without offering any additional advantages of longevity or maintenance.

Color selection has an enormous impact on the way a room looks and feels. Use color to highlight architectural features, but not to create a carnival atmosphere. See "Facade: Paint" in Chapter 4

PARTS OF A ROOM TO PAINT

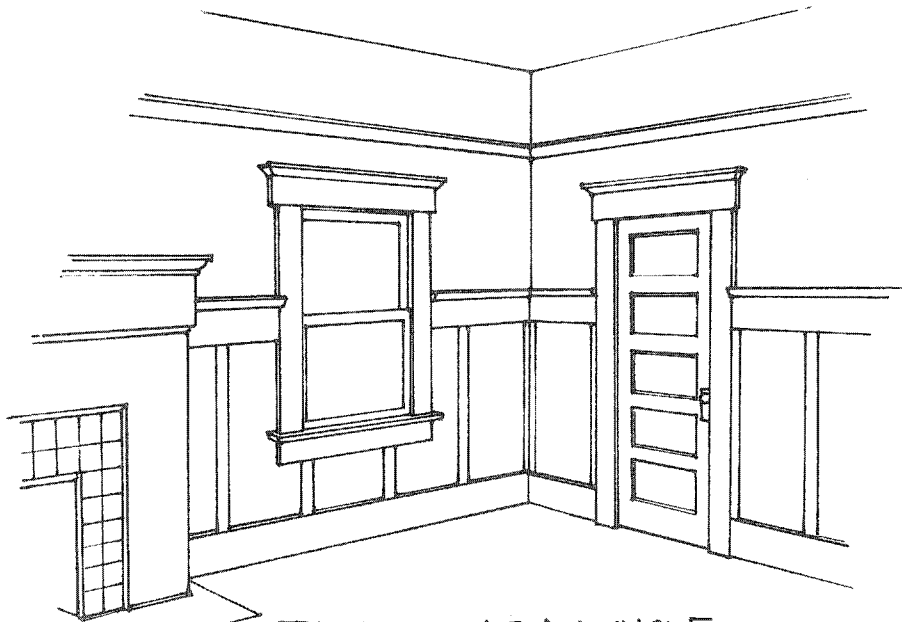

THE ROOM AS A WHOLE

IS THE FOREMOST CONSIDERATION. THE COMPONENTS THAT MAKE UP A ROOM SHOULDN'T DEMAND TOO MUCH INDIVIDUAL ATTENTION. COLOR CHOICES SHOULD CREATE HARMONY. IF YOU FEEL A NEED FOR BRIGHT COLORS, FILL IT WITH ARTWORK AND FURNITURE. ONE WAY TO CREATE HARMONY IS WITH A ONE COLOR PAINT SCHEME, BUT CHOOSE A LIGHT COLOR UNLESS YOU LIKE IT GLOOMY.

for a basic lesson in color, and follow these additional guidelines for interiors:

- It is generally best not to use more than two colors in a single room. The safest combination is a light color for the walls, and a darker shade of the same color for the molding and trim.
- If at all in doubt, use a single light color only, preferably a white or off-white.
- When selecting an off-white, pick the one that is tinted with a color that goes with the other colors, or woodwork, in the room. Hints of color, like

blue, green, or brown, are what make the off-white "off."

- Light colors make a room look more spacious. Dark colors make an average room look small and a small room look cave-like.
- Paint the ceiling white for more light and the feeling of more air. Almost all rooms can benefit from this.
- Warm colors (yellow, orange, red, brown, warm gray) make rooms with a northern exposure feel more inviting. Both warm colors and cool colors

(blue, green, cool gray) are appropriate to sunny rooms. It is difficult to combine warm and cool colors successfully.

- Historically accurate colors are a safe selection and a conversation piece.
- Where one room merges visually with the next, use blending colors. If in doubt, use the same color.
- For wainscoting that needs to be repainted, use a light, warm earthtone like beige, ivory, straw, or eggshell. Do not use a pastel.

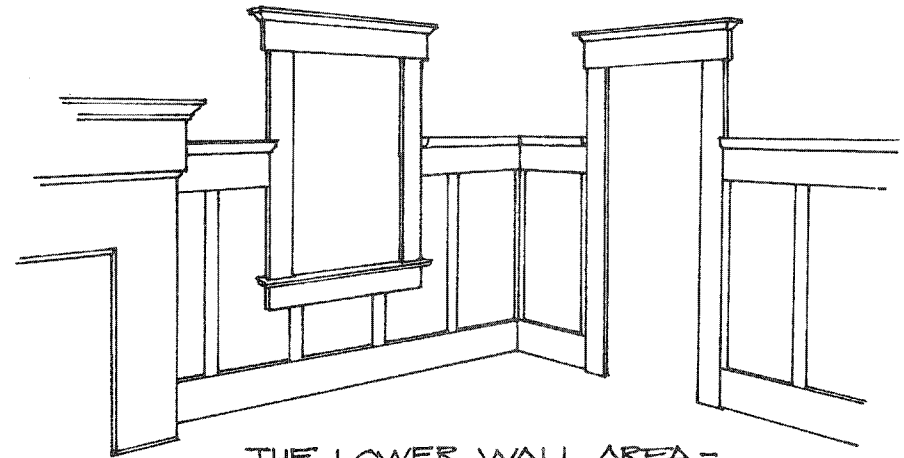

THE LOWER WALL AREA -

DETERMINES THE BASIC IMPRESSION OF THE ROOM. IF THERE IS UNPAINTED WOODWORK, LEAVE IT THAT WAY. (SEE - "WALLS : WOOD!") IF YOU DESIRE A 2-COLOR PAINT SCHEME, THE UPPER AND LOWER WALL SURFACES SHOULD RECEIVE THE 2 COLORS. IF THERE IS NO MOLDING DIVIDING UPPER FROM LOWER, IT CAN BE ADDED. TO UNIFY THE ROOM, THINK OF DOOR AND WINDOW TRIM AS PART OF THE LOWER WALL AND PAINT IT THE SAME COLOR. THE LOWER WALL AREA SHOULD BE DARKER THAN THE UPPER WALL - TO VISUALLY SUPPORT IT.

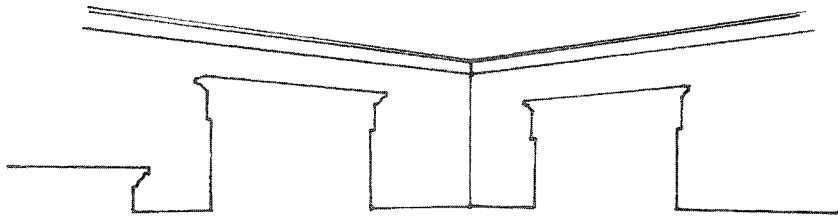

UPPER WALL AREA - THE CORNICE MOLDING SIGNIFIES THE END OF THE WALL AND THE BEGINNING OF THE CEILING, EVEN IF THERE IS MORE VERTICAL WALL SURFACE ABOVE IT. IN OLDER HOUSES WITH HIGH CEILINGS, THE POSITION OF THE CORNICE MOLDING KEEPS THE EXPANSE OF WALL SURFACE AT A MORE HUMAN SCALE. ACKNOWLEDGE THIS FUNCTION WHEN SELECTING PAINT BY REGARDING THE CORNICE MOLDING AS PART OF THE UPPER WALL AREA AND USING THE SAME COLOR FOR BOTH.

LEAVE THE CORNICE MOLDING UNPAINTED ONLY IF THE OTHER WOODWORK IS UNPAINTED OR THE CEILING AND UPPER WALL ARE DIFFERENT COLORS. OTHERWISE, THE MOLDING WILL LOOK LIKE A BOLD STRIPE INSTEAD OF THE JUNCTION BETWEEN CEILING AND WALL.

ACCENTS ARE OPTIONAL. WHEN USED, THEY SHOULD BE SUBTLE AND CHOSEN TO ADD INTEREST TO THE COLOR SCHEME, NOT COMPETE WITH IT FOR ATTENTION. A DARKER OR LIGHTER VARIANT OF THE BASIC WALL COLOR IS A GOOD CHOICE. ACCENTS SHOULD BE SMALL IN AREA (FOR INSTANCE, THE MOLDING AROUND THE FIRE-PLACE TILE AS OPPOSED TO AN ENTIRE DOOR).

- To dramatize a stairway balustrade, use the wall behind it as a foil. If the balustrade is natural wood, paint the wall a light color that matches the rest of the decor. If the balustrade is to be repainted, select a color contrasting but compatible with the wall. A dark wall calls for a light bal-

ustrade, and vice versa.

- Do not paint unpainted wood surfaces, brick or stone, fireplaces, ceramic tile, or floors.
- Do not use sickly colors like pale olive green, mustard, or chartreuse. Do not use garish colors like pink, violet, lavender, aqua or purple.

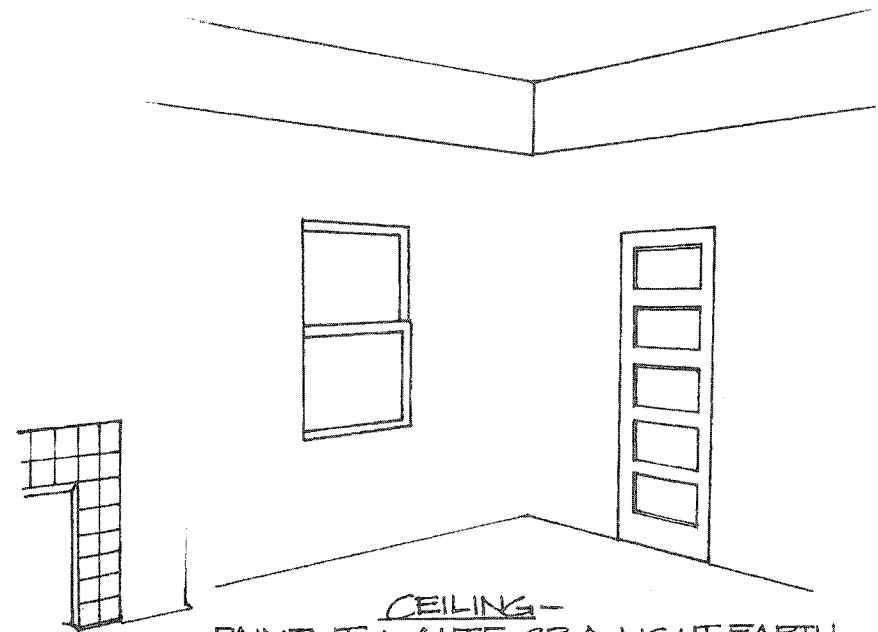

CEILING -

PAINT IT WHITE OR A LIGHT EARTH COLOR FOR REFLECTIVITY. DON'T PAINT NATURAL WOOD BEAMS.

DOORS AND MOVING WINDOW PARTS SHOULD BE LEFT NATURAL IF THEY AREN'T ALREADY PAINTED. OTHERWISE, PAINT THEM THE SAME COLOR AS THE LOWER WALL AREA OR OFF-WHITE. OFF-WHITE REFLECTS LIGHT INTO A ROOM AND, ON DOORS, SHOWS OFF THE SCULPTURAL QUALITY OF THE PANELS. DON'T HIGHLIGHT THE DOOR PANELS WITH COLOR - IT LOOKS "SPOTTY". LET SHADOWS DEFINE THE PARTS.

TILE AND BRICK SHOULD NOT BE PAINTED. IF ITS ALREADY PAINTED AND BEYOND YOU TO STRIP, PAINT THE BRICK OR TILE AN EARTH TONE WHICH COMPLEMENTS THE BASIC WALL COLOR.

- Do not paint over wallpaper with an oil base paint.
- Do not paint over wallpaper unless it is properly hung, and not brittle with age or about to peel off.

For instructions on selecting paint and tools, consult a home repair book, like the *Reader's Digest Complete Do-it-yourself Manual*, and your paint dealer. As with exterior paint jobs, **proper surface preparation is essential to success**, although it is rarely as difficult on the inside as out. First, repair any damage to the wall. (Refer to "Walls: Plaster.") Scrape off loose paint flakes and peeling wallpaper. Clean the surface with a common pre-painting solution to remove years of grime and oil. Feather edges created by chipped paint or old wallpaper. If the existing paint is enamel, it must be hand sanded in circular motion with a coarse paper to give the surface enough tooth for the latex to adhere. If layers of old paint are so thick that they obscure the detail of shapely wood features, it is advisable to strip the accumulated coats before repainting. (Refer to "Walls: Wood.") Since the surface will be repainted, the stripping need not be meticulous. Cabinet doors can be removed and dipped in a commercial stripping vat for about \$6 apiece.

Wallpaper

In the mid-19th Century, the first wallpaper color-printing machine was brought to the United States from England, and with that thousands of geometric and floral patterns became commercially available. **The art of wallpaper making peaked in the late-19th Century, and in most Victorian and some Colonial Revival and Craftsman houses, wallpaper was used to strengthen the composition of the room.** The lower walls (below the picture molding and above the wainscoting) usually had a consistent pattern, applied in vertical strips of paper, as is the custom today. The frieze area (between the picture molding and ceiling) usually had a single horizontal band of paper, often in patterns derived from actual frieze designs in classical, Renaissance and baroque buildings. The effect of this treatment is to give the portion of the wall above and including the picture molding the appearance of a single huge cornice. Sometimes, too, a much smaller horizontal band of paper was applied directly below the picture molding, giving the molding the appearance of a secondary cornice. Wallpaper was also used on ceilings. Sometimes it

was applied in successive strips, as on lower walls, and sometimes in borders around the ceiling rim.

Victorian and Colonial Revival patterns varied greatly. Frequently, they were used to create lavish effects similar to those associated with much more expensive materials such as wood, carved plaster and marble. Interestingly, in contrast to the architectural exuberance typical of the period, many of these wallpaper designs were rather delicate, derived from art nouveau or far eastern motifs. Authentic Victorian wallpaper used in the restoration of the Camron-Stanford house can be ordered through the Camron-Stanford House Preservation Association. Genuine William Morris papers are distributed by Reed Wallcovering Division, 550 Pharr Road, Atlanta, Georgia 30305.

Wallpaper was often supplemented in the Victorian house by stenciling, particularly for border effects, such as around the rims of chandelier rosettes, above and below moldings, and within frieze areas. Stenciling consists of tracing a pattern from a template, repeating it, and coloring it in with paint. To do this yourself, select a design from a reprinted Victorian pattern book, like the one published by Dover, and make a template from a rigid material, like cardboard. Further instructions are available in *The Old-House Journal*, and in *Stenciling*, by Megan Perry, available for \$12.95 plus 75¢ postage from Litton Educational Publishing, 7625 Empire Drive, Florence, Kentucky 41042.

In rehabilitation, wallpaper is properly used to add texture and interest in consort with the architectural features of a room. It is often mistakenly used as the focus of a room or as a substitute for valuable woodwork and trim erroneously removed. Serious restorationists try to duplicate the precise pattern of the original paper, or at least replicate a pattern popular during that era. For the purposes of REHAB RIGHT, a sensitive selection of a modern paper is perfectly acceptable and generally more economical.

Selection of the right wallpaper design starts with color, and the considerations are the same as those for paint, described previously. In addition, use the following guidelines to aid in the choice of pattern:

1. The **direction** of the pattern influences the way

the room feels. A strongly vertical pattern can make a low ceiling seem higher. A dominant horizontal pattern can make a narrow room seem wider. Generally, a vertical pattern anchors the wall visually and gives it more solidity than a horizontal or random pattern does.

2. The **texture** of the pattern determines the general impact of any wallpaper selection. Fine-grained patterns give an impression of overall color, while coarse patterns call more attention to the form of the individual shapes. Remember that on the test swatch of wallpaper, the pictograph seems all-important, yet on the wall, it is the cumulative effect that really matters. The eye tends to blend the colors and designs together. If in doubt, choose a fine-grained pattern with muted colors, rather than a large pattern with bold colors.
3. Stylized **patterns** are more effective than naturalistic patterns because abstracted designs create a textured surface, while realistic representations call attention to themselves like a painting.
4. For the area above wood wainscoting, and generally for high ceilinged Victorians, a paper with a vertical emphasis complements the architectural features and the interior space. The Victorians had exceptionally busy taste in wallpaper design, but there is no need to abide by their precedent unless it appeals to you.
5. **Do not use theme papers** to try to make a house look old. Representations of Colonial America with horse and buggies do not belong in a Colonial Revival house. Likewise, red flocked wallpaper that connotes the Gay Nineties in a pizza parlor is not at all suited to a large Victorian residence.
6. **Do not use contact paper.** It looks shoddy and harms the plaster. There are an ample number of wallpaper products which are just as convenient. You can buy wallpaper that is washable, prepasted, scuff-resistant, pre-trimmed, and strippable, in addition to the standard product.

Actually, "wallpaper" is something of a misnomer,

as much of it is made of vinyl, metallic foil, burlap, fabric, cork and even wood. This points out the possibility of using fabric as wall covering instead of paper, especially if you're looking for a textured solid color. Burlap, stretched taut across the wall surface, looks particularly well in Craftsman Bungalows and Brown Shingle style houses. Rice paper was also a wallcovering original to these styles.

A selection of 13,000 rolls of post-Victorian, pre-1941 wallpaper is available at Last's Paint and Wallpaper, 1051 Valencia, San Francisco, for 49¢ to \$2.98 per double roll.

Trim

Throughout this book, **REHAB RIGHT** recommends respect for architectural features. The architectural features are what's left in a room after all the furnishings have been removed. They stay with the house, from one owner to the next, and make a room look complete. **Architectural features contribute to the resale value of the house.**

An architectural feature easy to identify is the original wall trim. **It is extremely important for esthetic and economic reasons to retain the wall trim.** Fortunately, if the trim is missing, it is fairly easy and inexpensive to replace. Trim includes door frames and caps, window frames and caps, cornices, baseboard, chairrail, and assorted molding. Visually, trim breaks up the mass of the wall, and adds sculptural interest to an otherwise flat plane. Functionally, it conceals seams and joints.

The words "trim" and "molding" are often used interchangeably because trim is typically made of one or more pieces of molding. In Early American houses of the 18th and early 19th centuries, elaborate wood moldings, hand-carved with simple tools, constituted the personal signature of the carpenter. By the Victorian period, standardized molding was milled commercially. Eight classic shapes derived from Greek and Roman precedents formed the basis for molding design, and do to this day. Victorian builders took advantage of the great variety and convenience of mass-produced molding and combined the patterns into imaginative wall decorations. Although taste became more simplified in subsequent years, molding itself persisted as

BASIC MOLDING SHAPES

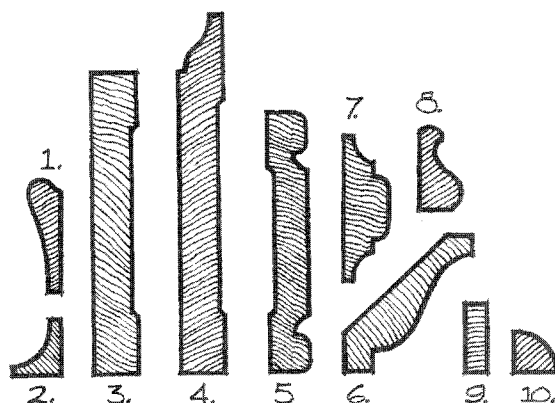

1. PICTURE; OFTEN USED ALONE AS A SIMPLE CORNICE
2. COVE
3. BASE
4. BASE WITH INTEGRAL "OGEE" CAP; SOMETIMES USED UPSIDE DOWN AS PART OF A CORNICE
5. CHAIR RAIL
6. CROWN
7. ASTRAGAL
8. BASE CAP
9. LATTICE; CUT INTO SECTIONS TO CREATE DENTILS
10. QUARTER ROUND; OFTEN USED AS SHOE MOLDING

an essential part of the wall in all of the REHAB RIGHT architectural styles.

If the molding is still intact, preserve it. **Repairs to the walls, floor or ceiling may involve temporary removal of the molding. Remove molding carefully, and only when absolutely necessary.** If the molding is painted, sand the surface enough to locate the nailheads. Gently work a stiff, broad-bladed putty knife behind the molding, lifting it enough to insert a small, flat prybar or the claws of a hammer. Put the end of the prying tool into the gap made by the putty knife, placing it as close as possible to where a nail passes from molding to wall or woodwork. Pad any spot where the prybar presses on visible woodwork or plaster with thick cardboard.

Pry the molding away just far enough to allow the prybar's insertion at the next nail. Where the last nail is reached, the whole molding should stand away slightly from the surface behind. Now work back from nail to nail, increasing the gap a uniform amount each time. After two or three passes in this manner, the molding should be loose enough to pull off by hand. Wood wedges or scraps of shingle may be helpful to keep the molding from springing back and closing the gap.

Sometimes molding is secured by nails in opposing directions. Check to see if this condition exists before pulling molding off in one direction, as it will probably split. In this case, or if a molding begins to crack, drive nails all the way through the molding into the surface behind with a nailset and hammer. This works with finish nails only. (Consult the *Reader's Digest Complete Do-it-yourself Manual*, and Chapter 4 "Facade: Ornamentation.")

Some portion of the molding may be damaged and require replacement, or all too often, the molding may be missing due to a previous misguided improvement effort. Molding does not self-destruct; loss or damage is due to active interference by remodelers. Occasionally there will be a replacement right in the house, if molding was saved when a wall was removed or a closet added. Otherwise, a trip to the lumberyard is called for. **A simple molding can be replaced outright. A more complicated pattern requires the combination of two or more basic moldings, just as the Victorians did themselves.**

Always buy wood molding, either pine or redwood. Never settle for extruded metal molding with a wood veneer, or wood molding with a layered vinyl veneer. Nor should you allow a hurried or unimaginative salesperson tell you that what you want is "impossible" or "not done that way." Determine the size and shape of the moldings you need based on the original, as illustrated.

In 1957, a system called the WP/Series was introduced to categorize the vast number of stock molding sizes and styles. A $\frac{5}{8}$ " \times $\frac{5}{8}$ " quarter round, for example, is called WP 107. This classification replaced a numbering system, probably developed in the 1880's, which identified molding styles by a

four-digit number, beginning with a 4000 series and continuing into the 8000's. A catalog illustrating high volume, stock molding designs and sizes with WP numbers can be ordered for \$1.00 from: Western Wood Molding and Millwork Producers, P.O. Box 25278, Portland, Oregon, 97225. Standard molding costs from 6¢ per foot to 69¢ per foot, depending on its complexity.

If the trim is missing altogether, it is advisable for aesthetic and investment purposes to put it back in place. A pattern for an exact duplicate of the original molding can sometimes be deciphered by looking for old paint profiles at the edge of door frames or in the corner of walls. Authentic copies of Victorian molding are available in stock at San Francisco Victoriana, 606 Natoma Street, San Francisco. Ask for their catalog. Custom-made molding for Victorian and other house styles can be ordered from Bartley Milling Company, 8515 San Leandro Street, Oakland. For recycled house parts, try Berkeley Architectural Salvage, 2750 Adeline Street, Berkeley and Campanella Salvage, 2700 E. 7th Street, Oakland.

If it is impossible to surmise the silhouette of the original molding, or precise reproduction is too costly, a perfectly adequate replacement can be installed using standard parts as long as the proportions are correct. Baseboard, for example, must be thick enough and high enough to visually anchor the wall to the floor. For baseboards in Colonial Revival houses, consider using a piece of exterior drop siding, with a base cap on top. That's what the original builders did. (Refer to the illustration "Do's and Don't's for Sheetrock," under "Walls: Plaster" for proper size and placement of baseboards.) Picture molding must be at the proper location on the wall to relate the height of people to the height of the ceiling. Remember, it was originally used to hang picture wire from.

Trim can be used with great success to make a plain house look a little more fancy as long as it is within the bounds of the architectural character. Supplement plain window or door frames with caps. Be certain the caps are consistent with one another. Add a chairrail or platerail to the top of wainscoting, or add cove molding where wall and ceiling meet. A piece of molding about 4"-6" wide, about

REPRODUCING COMPLEX MOLDINGS

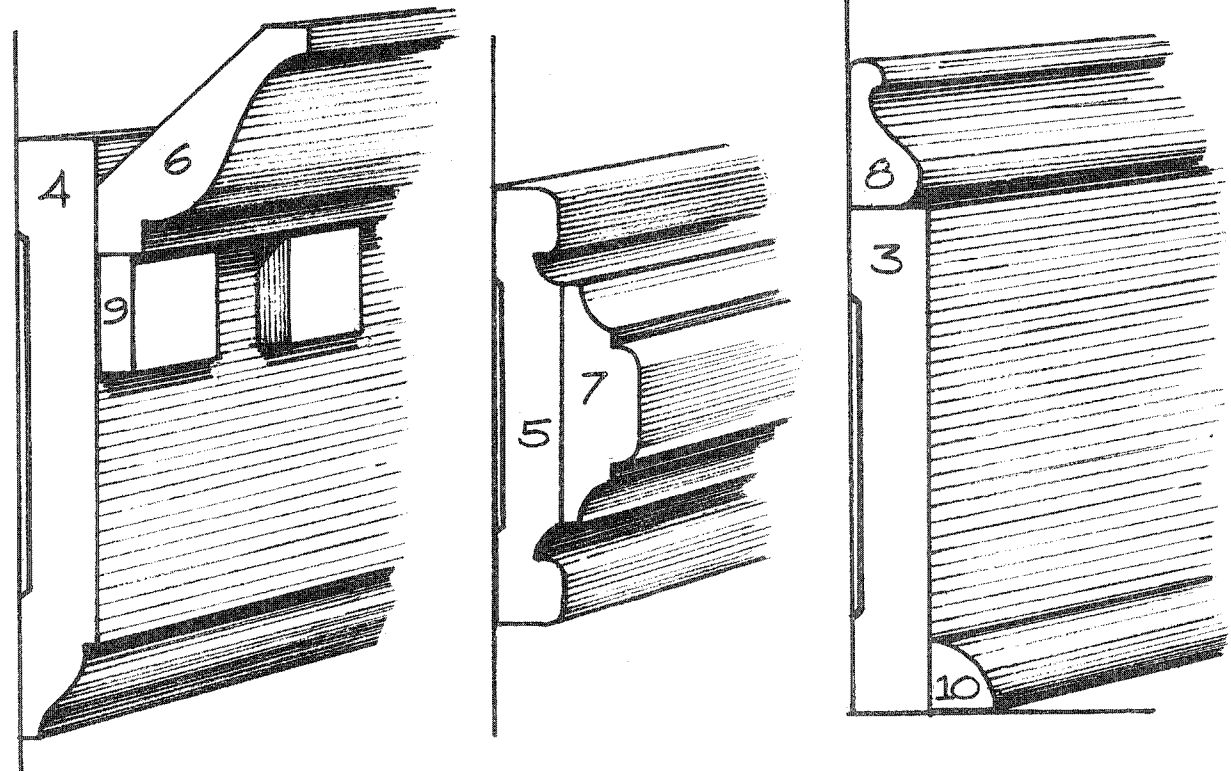

CORNICE CHAIR RAIL BASE MOLDING

TRIM MAY CONSIST OF A SINGLE MOLDING OR IT MAY BE BUILT-UP FROM 2 OR MORE OF THE BASIC SHAPES. THE COMPLEX TRIM PIECES SHOWN ARE NUMBER CODED TO THE PREVIOUS ILLUSTRATION TO REVEAL THEIR INDIVIDUAL COMPONENTS.

ADDING A WINDOW CAP

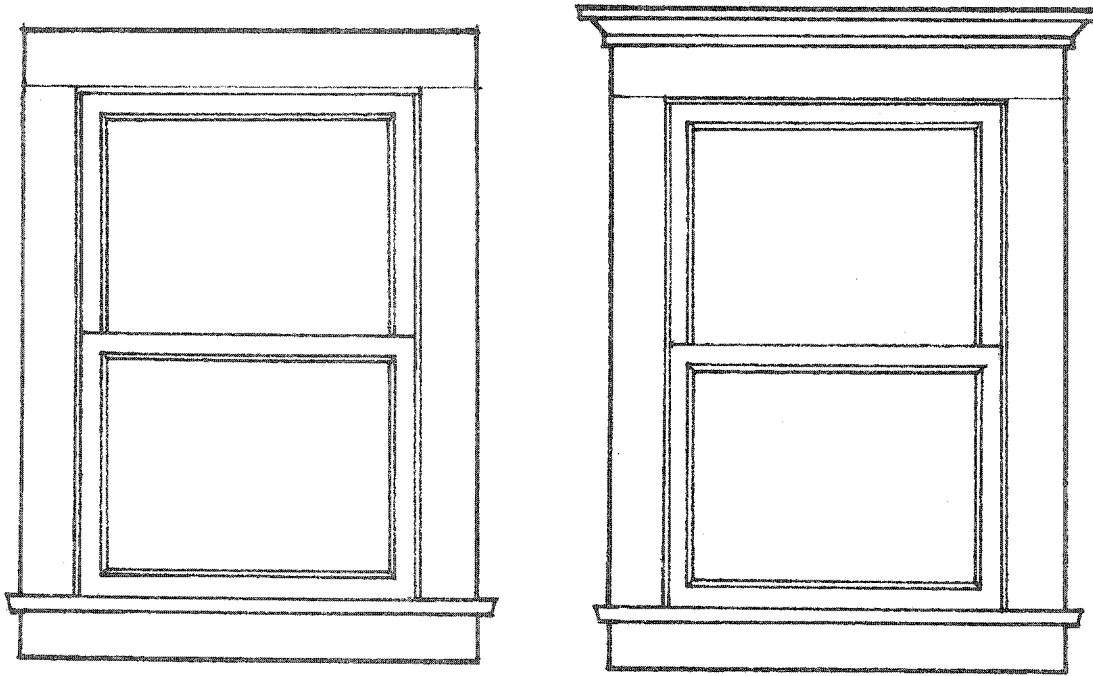

PLAIN, FLAT DOOR & WINDOW TRIM CAN BE ENHANCED BY ADDING CAPS OF THE PROPER PERIOD. THE WINDOW CAP SHOWN WOULD BE SUITED TO A CRAFTSMAN OR COLONIAL REVIVAL WINDOW. BE CONSISTENT: ADD CAPS TO ALL THE DOORS & WINDOWS IN A ROOM AT ONCE.

3½' from the floor on a 9' high wall can create a valuable visual dividing line for different wall surfaces or paint colors. (The bottom section should always be darker than the top.) If you're stuck with a modern, flush door, use molding to imitate the patterns of a real panelled door.

When adding new molding, always choose classic designs that are suitable to the architectural character of the house. Do not use scallops, inverted scallops, fake friezes, heavily embossed Spanish styles, or any other decorative pattern that calls attention to itself.

MOLDING TO AVOID

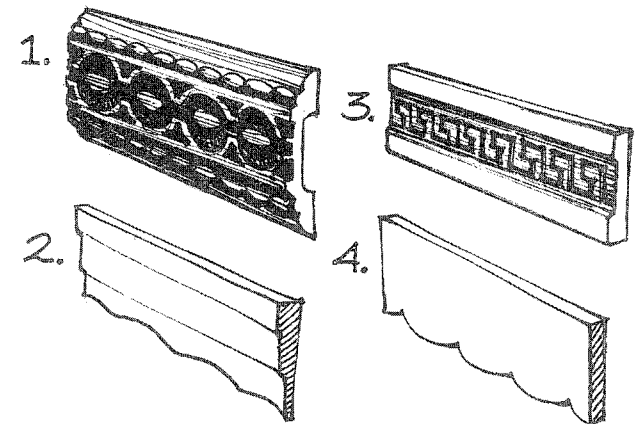

1. EMBOSSED*
2. REVERSE SCALLOP
3. FRIEZE*
4. SCALLOP

* MAY BE PLASTIC, WOOD OR METAL

Some original trim is made of plaster instead of wood. Plaster cornices are found in Italianate, Colonial Revival and Prairie School houses. If the plaster has deteriorated, it may be expedient to use a combination of wood molding pieces to construct an acceptable replacement. Four basic shapes make up the forger's palette: the one-inch square,

THE DIFFERENCE BETWEEN A STRUCTURAL WALL AND A PERMANENT PARTITION

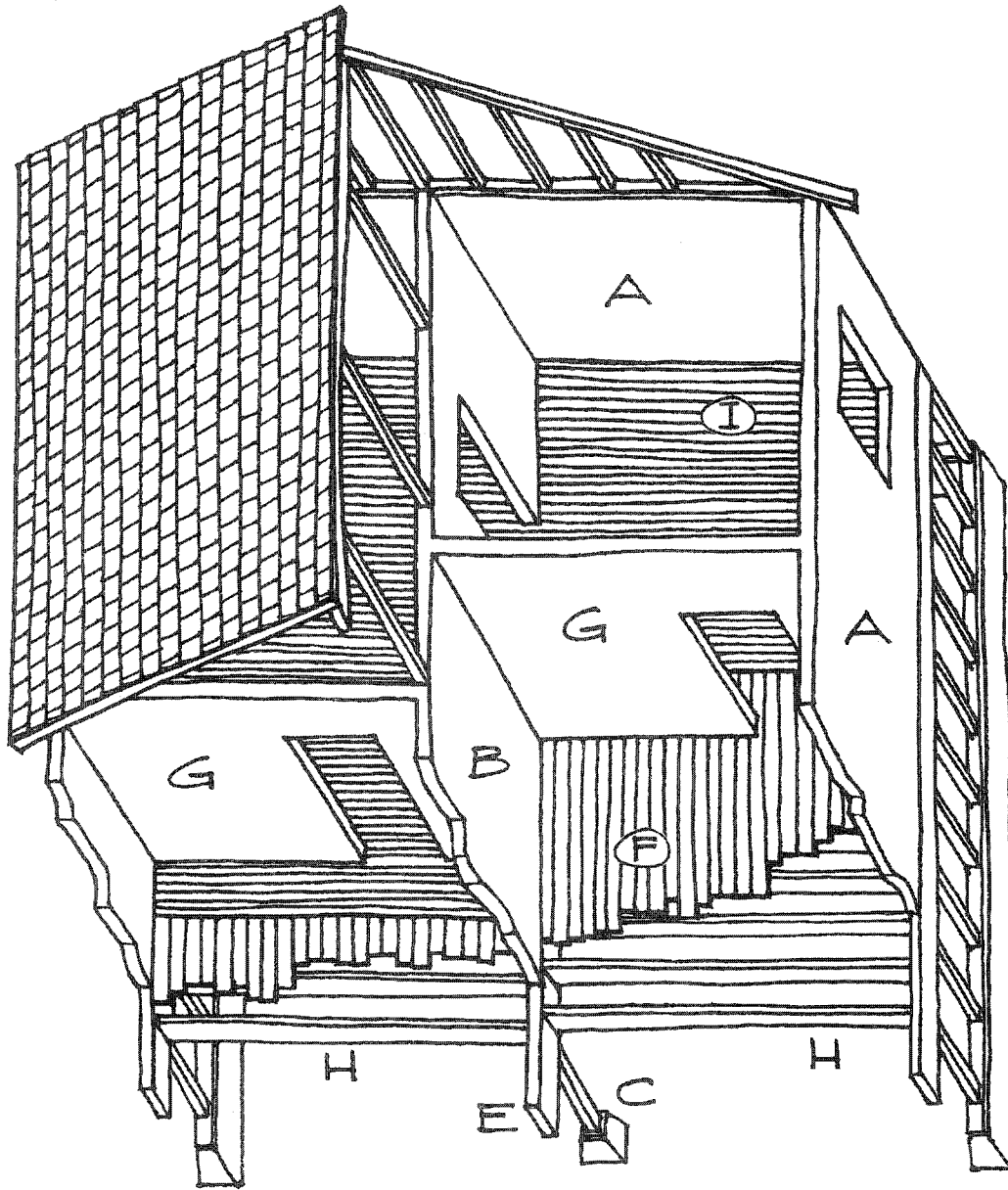

ALL EXTERIOR WALLS (A) ARE LOAD-BEARING. IN ADDITION, THERE ARE INTERIOR LOAD-BEARING WALLS (B) WHICH HELP TRANSMIT THE WEIGHT OF ROOF AND CEILING TO THE INTERIOR FOOTINGS (C) AND THE PERIMETER FOUNDATION (D). INTERIOR LOAD-BEARING WALLS SIT ATOP A FOUNDATION BEAM (E) AND ARE PARALLEL TO THE:

- SUBFLOOR (F)
- CEILING LATH
- CEILING CRACKS.

NON-LOADBEARING WALLS (G) ARE LIKE FLOOR TO CEILING PARTITIONS. THEY ARE USUALLY PARALLEL TO THE:

- JOISTS (H)
- FINISH FLOORING (I).

cove, half-round and quarter-round. Use plywood and/or masonite as a base and for projections.

Otherwise, a plaster cornice can be reproduced by a process called "running the molding". This involves making a template that is the exact reverse of the cross-section of the molding you want to duplicate, throwing wet plaster up on the wall, and running the template over the wet plaster to shape. This is how it was done originally. Techniques for replacing plaster cornices are described in detail in *The Old-House Journal*. An example of restored "run" plaster moldings can be seen at the Camron-Stanford house.

Removing Walls

The floor plan of a house can sometimes be improved by removal of a wall. A Victorian kitchen, for example, consisting of a trio of small rooms—one for cooking, one for washing, one for storage—may be converted to a single large room with a convenient work triangle and space for the family to gather. Or, in a Bungalow, two small bedrooms might be combined for a master suite.

When planning, **envision the shape of the space that will result.** Keep in mind the proportions of the room, the relationship of height, width and depth. More floor area is not the only criterion. A room that is made longer must be wide enough not to feel like an alley. A room that is made bigger must be high enough not to feel like a cellar.

Never remove a wall before its structural role is determined. Walls that are load-bearing support the ceiling above them. The overhead weight must be transferred to another support before the wall is removed, or collapse is likely. Non-loadbearing walls are more like floor-to-ceiling partitions. They separate one room from another, but play no part in the structure of the house.

Consult an architect or a builder for a professional evaluation of the wall's structural role, and recommendations regarding transfer of loads. Removal of a wall requires a building permit. The field visit by the building inspector is a valuable check on the safety of your plans.

Before the wall is demolished, salvage architectural

features from it for use in other parts of the house. Molding, wainscoting, doors, doorframes and caps are especially useful for clothing a stripped wall elsewhere as well as for incorporating a new addition sympathetically.

CEILING

The height and surface of the ceiling have a powerful influence on the way it feels to be in a room. A high ceiling, for example, suggests formality, and provides a setting that seems spacious enough for groups to gather, even if the dimensions of the floor plan are not that generous. A low ceiling suggests informality; and provides a more intimate setting for conversation or privacy. The height from floor to ceiling should be in proportion to the length and width of the room to ensure that the interior spaces will not seem awkwardly squat or elongated. Often, the ceiling heights within a house will differ from one room to the next to offer the residents a variety of living environments. The ceiling height original to each room in a house was intentionally selected to express the function of a room and the mood of the architecture, and this should be respected in the course of rehabilitation.

Whatever ills befall an old ceiling—and prone they are to cracks, for like the walls on Oakland's pre-World War II houses, the ceilings are made of plaster—**never change the original ceiling height.** The so-called "solution" offered by most home repair books to the problems of deterioration posed by aged plaster ceilings is to install a modern, dropped, acoustic tile surface overhead. This is no solution at all. It is an unnecessarily costly cosmetic cover-up that clashes with the architectural character of the house. Such measures reduce the appeal of the house rather than increase it.

Surface

Ceiling damage is not impossible to reverse and the repair process is generally less expensive than conversion to a modern, inappropriate ceiling style. Plaster ceilings are subject to cracks and holes due to settlement, water leakage, and improper instal-

lation of hooks or fixtures. Always correct the cause of damage, like faulty plumbing, before correcting the symptom. Use the same techniques described for the repair of plaster walls, with the additional help of a sturdy ladder or two. Plaster dust from the ceiling can blanket a room, so cover floors and furniture, or remove the furnishings entirely.

Occasionally, plaster ceilings begin to sag because over time the lime in the plaster may corrode the lath nails. The bulging surface can be pressed back into place by drilling a hole through the plaster and installing a ceiling anchor.

For extensive damage, **the ceiling can be replastered, or sheetrock can be installed** by a technique similar to replacement of a wall. Refer to the *Readers Digest Complete Do-it-yourself Manual* for more detailed instructions. If the ceiling has ornamental trim, take the steps necessary to remove, save, and replace it. After attaching the sheetrock and taping the seams, prime and paint it. Unless there is an original plaster texture on the walls in the same room that warrants repetition, **do not trowel on an additional texture.** The use of a paint roller with thick pile is perfectly adequate. It will lend very subtle relief, and mask small imperfections in the sheetrock surface in the course of painting.

Compare costs for resurfacing the ceiling of a small room, measuring 8' by 12'. The preferred sheetrock method would cost about \$40, complete. (3 sheetrock panels, 4' x 8' x 1/2" @ \$4/sheet, sheetrock tape and joint compound @ \$10, one gallon of lucite ceiling paint @ \$10, one hi-pile paint roller with a 9" frame @ \$5, one or two paintbrushes for \$3.) The acoustic tile method would cost \$92, more than twice as much. (96 square feet of acoustic tile at 55¢/square foot average, 96 linear feet of 1" x 3" furring strips @ 20¢ a linear foot, staple gun and staples \$5.) The larger the ceiling, the greater the price differential will be.

If you must use a modern ceiling surface:

- Select a modern product that is plain white, without patterns, glitter or volcanic eruptions. Respect the fact that the original plaster was flat and entire.
- Select as neutral a surface as possible. The ceiling

CEILING: DO'S AND DON'T'S

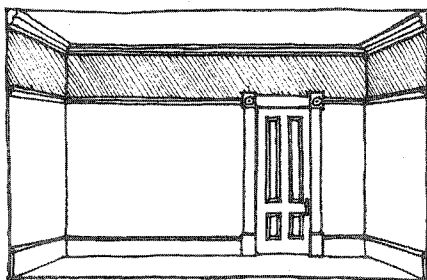

PREFERRED

ORIGINAL CEILING AND WALL TREATMENT OR SHEETROCK CEILING WITH MOLDING REPLACED.

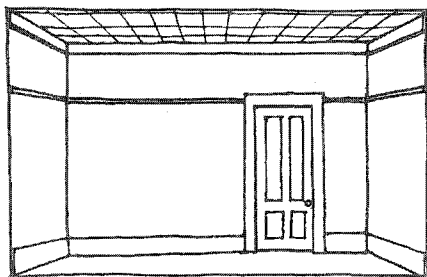

ADEQUATE

NEW MATERIALS BUT PROPORTION AND LOCATION OF ORIGINAL ELEMENTS ARE RETAINED. PLAIN ACOUSTIC TILES ARE PLACED DIRECTLY UPON THE CEILING, ABOVE A MOLDING OF ADEQUATE WIDTH.

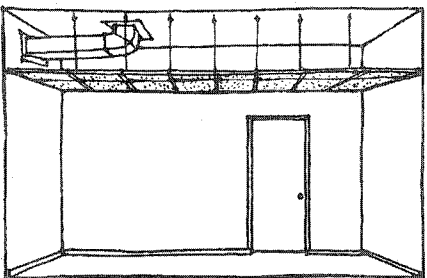

OBJECTIONABLE

LOWERED CEILING WITH HOLES OR HEAVY TEXTURE ON THE SURFACE OF THE PANELS. DECORATIVE ELEMENTS AND PROPORTIONS OF THE ROOM ARE DISREGARDED.

is not a planetarium.

- Install it at the same level as the original ceiling. If the plaster is in place, smooth it out by the same techniques described for plaster repairs, and glue the tiles directly to the plaster with a special contact adhesive manufactured for that purpose. If the plaster and lath have been removed, nail furring strips no more than 1" thick directly to the joists of rafters above, and staple the tiles to them.

Space

Never suspend the ceiling. In addition to the questionable purposes of cosmetic concealment and outright modernization, dropped ceilings are also misused as a way to hide new wiring or plumbing, as acoustic mufflers, and as heat conservers. There are alternative approaches to each of these situations that are much more sensitive to the architectural style.

To reduce fuel costs, install insulation between the interior wall surface and exterior walls to minimize the heat transfer. If the wall is to be rebuilt, batt or blanket insulation is the typical selection. If the walls are in place, loose fill insulation can be blown into the space between the walls by an operator specializing in this technique. To muffle sounds, use rugs, drapes, upholstery, or fabric "wallpaper" to absorb the reverberation. To isolate sounds from other rooms, and if the base moldings and other trim will accommodate it, use two layers of wallboard instead of just one. To conceal new plumbing and wiring, plan modernized utility systems in advance of other improvements so that closets, shafts and floor space can be used to their best advantage. (Refer to "Utility Systems.")

Special Features

Where special architectural features distinguish a ceiling, **these assets should always be retained.** If the features are missing, but belong to the style, it is to the building's advantage to replace them.

Rosette

Victorian and Colonial Revival houses are fortunate

to possess a rosette in the middle of the ceiling as a highly decorative support for the chandelier. A rosette is a circular plaster sculpture shaped like a flower, hence its name. Small rosettes are molded in a single piece as small as 6" in diameter, while others are assembled in several sections, or wreaths, and are as wide as 4' in diameter. The rosette design is in proportion to the size of the ceiling, the volume of the room, and the shape of the original light fixture.

In Victorian times, the rosette was integrated in the ceiling plaster. Segmented rosettes were additionally supported by tie-wires, threaded through the lath to the structural member above. Thus, major repairs to the rosette require cutting it out of the ceiling. Saw through the lath around the perimeter of the rosette, supporting it as you do so. Use a long chisel to loosen it from behind, and a hacksaw to sever the tie-wires. This may be easier from the floor or attic above it.

Once the rosette is off, you can strip accumulated paint by dipping the rosette in a pan of very hot water right on the stove and scrubbing with a toothbrush. The difficult layer is the calcimine, closest to the plaster. Fill in small cracks and holes with plaster. If necessary, rebuild missing sections with a self-mold and casting plaster. When sanding, be very careful not to smooth sharp edges, or you will destroy the detail instead of resurrecting it. Prime and paint, as you would a new rosette.

Re-install the rosette in the original way by replacing it in the hole in the ceiling and securing it with tie-wires and a fresh coat of plaster. Or, secure the rosette with bolts and screws to the joists.

A much simpler solution, if the rosette is missing, broken, or obscured by countless layers of paint, is to buy a new one. San Francisco Victoriana has a selection of 42 different styles, ranging in size from 13" to 48" in diameter. The average price is \$1.25 per diameter inch. Complete instructions are provided to guide installation.

Even if the original light fixture is missing, you can still take advantage of the rosette. Select another pipe type chandelier that looks appropriate, even if it is not an accurate reproduction. (Refer to "Utility Systems: Electricity" for guidelines on fix-

ROSETTE CROSS-SECTION

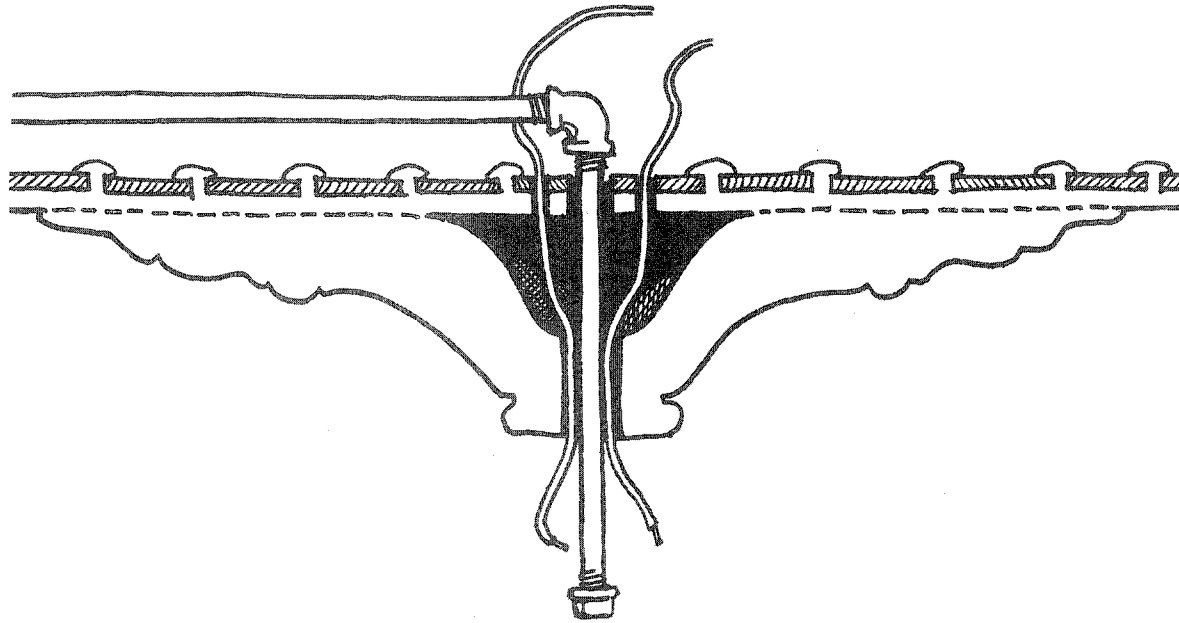

THIS IS A CROSS-SECTION OF A PLASTER ROSETTE, APPLIED TO THE CEILING WITH PLASTER OF PARIS (AND WIRE TIES FOR THE LARGE, SEGMENTED ROSETTES). A HOLE WAS PROVIDED FOR A GAS PIPE AND THE CAPPED PIPE OFTEN REMAINS DESPITE THE REPLACEMENT OF GAS FIXTURES WITH ELECTRIC ONES. ELECTRIC WIRES WERE RUN THROUGH THE PIPE HOLE.

ture selection.) If the gas line is not yet sealed, have the line capped off by a qualified plumber. Amateurs should not handle gas lines that may still be active.

Trim

Victorian and Colonial Revival houses have ceiling moldings made of wood, or more commonly plaster. Ceiling molding, cornices, or other trim should be retained, removing and replacing them if necessary in the course of ceiling repair. (Refer to "Facade: Plaster Ornamentation" and "Walls: Trim.")

Half a century or more of paint jobs can result in a nasty accumulation that blurs the crisp juncture of ceiling and wall. To correct this, use a manual paint scraper to score and remove the build-up. Sand the edge of the newly exposed layers of paint so that the transition from thick paint to scraped corner is as smooth as possible. To conceal the build-up instead of correcting it, paint the corner as is, then add a strip of suitable cove molding around the perimeter and cover it up.

Beams

First Bay Tradition houses, and some Colonial Revival houses, boast exposed beams on the living room and dining room ceiling. Or, they may have imitation coffered ceilings which are made of stepped planks, combined to resemble timbers and criss-crossed to suggest recessed panels. If wood ceiling ornamentation has been painted so many times that the angular corners have become rounded, or if you choose to reveal the natural wood as is so well-suited to the Craftsman styles, strip the paint by one of the techniques described under "Walls: Wood." Natural wood beams are dramatic, and a real architectural asset since they are a rarity in new residential construction.

Coved Corners

Coved ceilings are found in selected Victorian houses and their use persisted in some examples of the Colonial Revival, First Bay Tradition and Period Revival styles. Coved ceilings were created by attaching the lath strips above the cornice or

COVED CEILING DETAIL

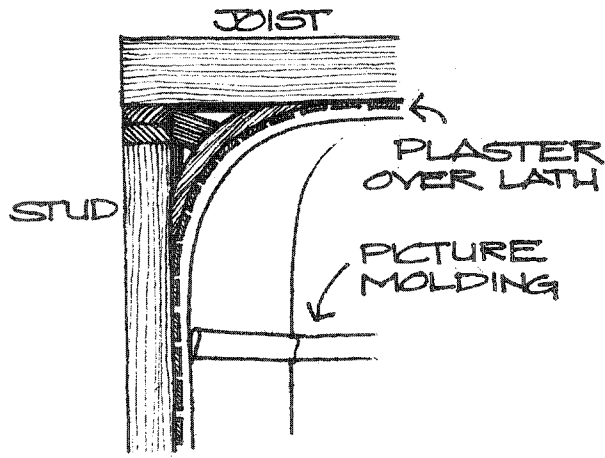

picture molding to a curved framework instead of to the studs. This framework usually describes a quarter circle between the wall and the ceiling surfaces. Repair techniques for a coved ceiling are identical with those for conventional plaster walls, as the basic construction technique is the same. However, if damage is severe enough to call for replacement, the surface must be replastered because sheetrock is inflexible and cannot be nailed to a curved surface. If coved corners are intact, keep them in place. If they are in disrepair, it is worthwhile to attend to them because coved corners give a room a special sense of enclosure that makes the space particularly nice to be in.

DOORS

Style

Classified by construction method, there are three types of interior doors: the panel door, the solid core door, and the hollow core door. **The panel door is the type original to all Oakland house styles discussed in REHAB RIGHT**, except the Wartime Tract. The panel door is made of a wood outer frame inset with recessed wood panels or with glass which is often frosted, stained, or leaded.

Panel doors are three-dimensional by nature, and they distinguish a room the same way a fine piece of handcrafted furniture does.

In sorry contrast, the solid core and hollow core door are plain, flat, and mass-produced. The solid core door is made of layers of wood laminated together with glue. The hollow core door is made of a wood frame filled with honeycomb cardboard and covered by sheets of lightweight veneer.

It is a grievous error to replace panel doors at the entry to a room or a closet with solid or hollow core counterparts, or to camouflage a valuable panel door under a sheet of plywood in imitation of its arch rival. Here's why:

- Panel doors match the architectural features of older rooms, and core doors do not. The molding that outlines the recesses, the proportion of the panels, the sturdiness of construction, and the solidity of appearance, all look right with the other architectural features in the room. A core door is woefully out of place.
- Panel doors match the door frame, itself a composition of molding, trim cap, and baseboard. A core door in this context looks like the piece of cardboard in a fancy picture frame before the work of art is mounted.
- Replacing a worn or damaged panel door with a "carefree" modern door is wasteful. Most prob-

TYPES OF DOORS

PANEL DOOR

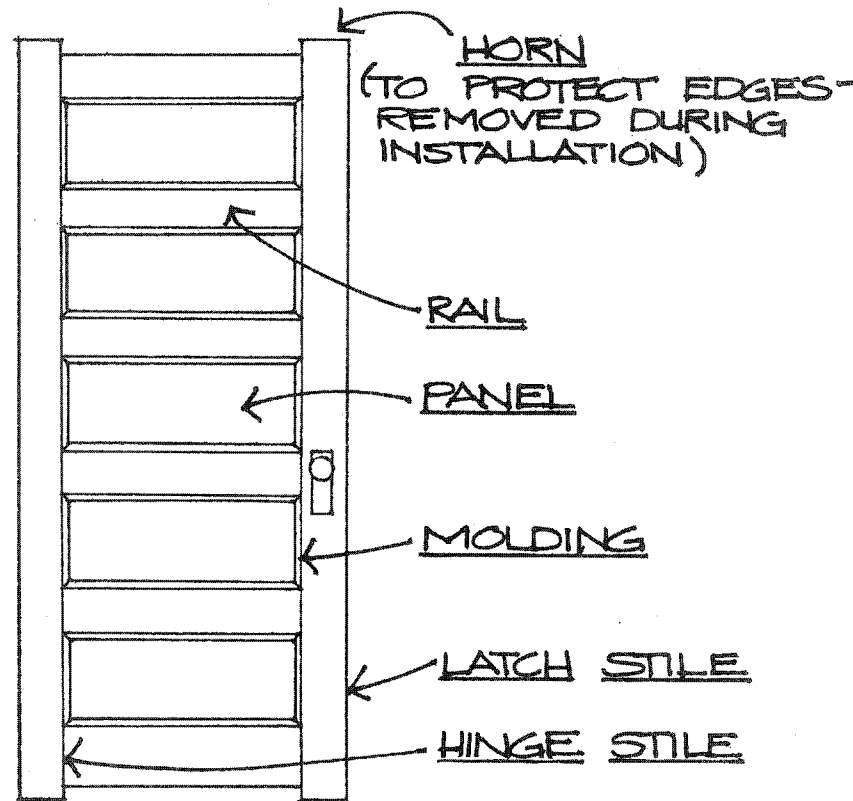

FLUSH DOOR

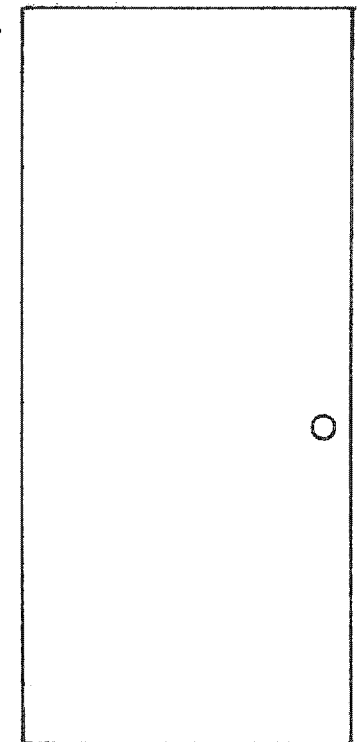

blems experienced with panel doors can be repaired at practically no expense, and the result is a door that is far more durable than a core door—particularly a flimsy hollow core door—will ever be.

- Thanks to their solidity, panel doors offer more effective sound insulation than hollow core doors.
- Panel doors are usually outfitted with more attractive hardware. The knobs and hinges available for core doors do not compare in execution of detail.
- Panel doors are architectural features that stay with the house and add to its resale value, contrary to what a core door salesman may tell you.

Fit

All doors are subject to binding or looseness, but panel doors more so, simply because of their years in service. Usually this is not a fault of the door itself, but a matter of poor fit at the hinges or lockset, or excessive layers of paint. **Correcting a balky panel door is so inexpensive that no justification exists for switching to a modern door style.**

There are three common causes of balky doors: a set of improperly adjusted hinges, distortion of the door so that it no longer fits the frame, and distortion of the frame so that it no longer fits the door.

To determine which is the cause, stand so the door opens toward you, but keep the door closed. Take a coin, or a piece of wood 1/16" thick, and slide it along the space between the door and the jamb. Pinpoint the sticky spots where the coin won't slide. If there is a large gap at the opposite side of the door from the stubborn spot, then the problem is a loose hinge. If the door fits too tightly all the way around, and you can't fit the coin on the top and bottom, then the door has probably swelled from dampness or paint and the troublesome edges require planing. If the coin hits several sticky spots at random locations, and if there are telltale cracks in the plaster around the doorframe, then the house has probably settled and caused the doorframe to shift position and press on the door at several points. This too requires planing. It is far simpler to fix the door than the door frame.

PANEL DOOR CONSTRUCTION

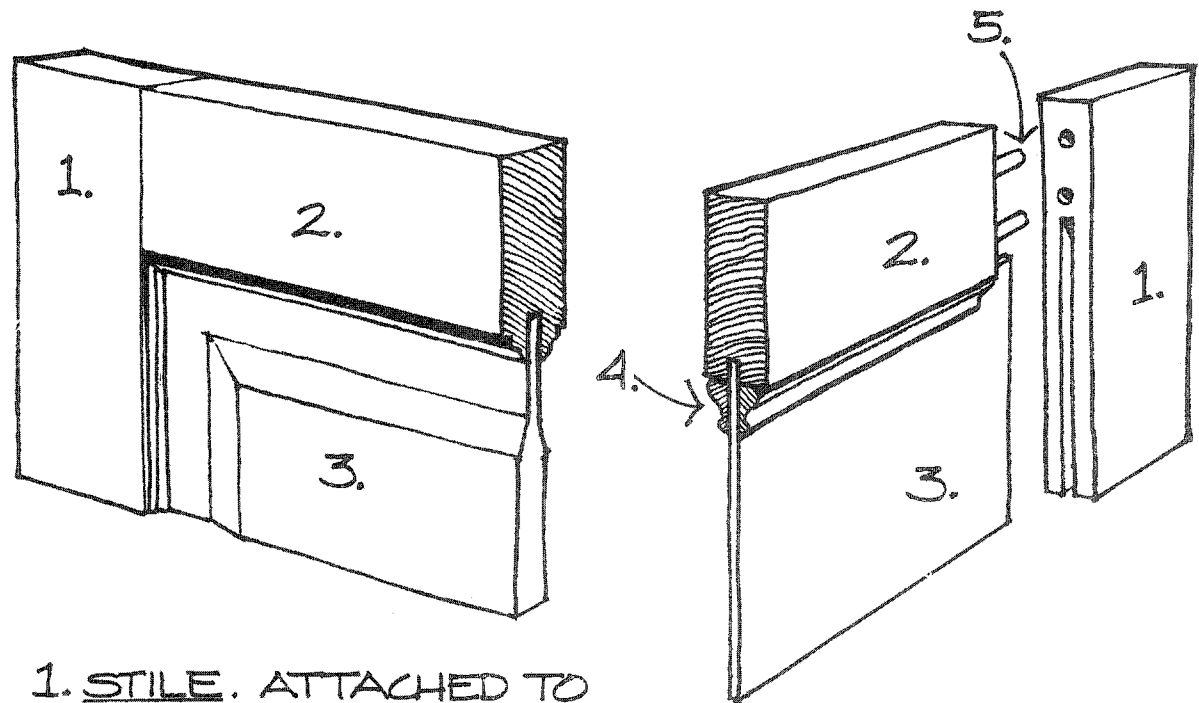

1. STILE. ATTACHED TO RAIL WITH DOWELS OR MORTISE & TENON METHOD.
2. RAIL. RAILS & STILES SOMETIMES HAVE A CARVED EDGE SIMULATING MOLDING.
3. PANEL. SOMETIMES BEVELED
4. MOLDING.
5. DOWELS

Consult a home repair book, like the *American Handyman* or *Sunset Basic Home Repairs Illustrated*, for the specific techniques necessary to tighten loose doors and loosen tight doors, like planing, shimming, door removal and door hanging.

Damage

Worn panel doors may have a kicked in panel or a loose rail. Thanks to its construction, **the panel door can be dismantled and the damaged piece repaired or replaced**, as illustrated. Compare this

FLUSH DOOR CONSTRUCTION

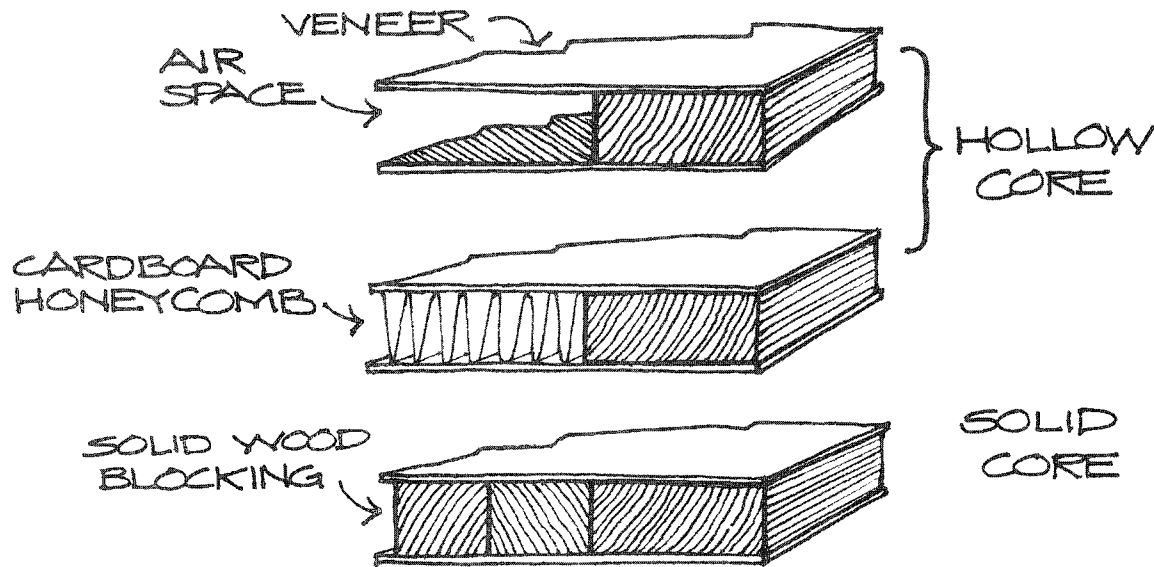

to the flush or solid core doors which once damaged offer no repair options and require costly replacement.

Often, after a succession of occupants over the course of half a century, panel doors become swaddled in coats of paint. The crisp edges and recesses lose their definition, and the angular corners become rounded. To resurrect the geometric form of the door the paint should be stripped, even if you plan to paint it again. (Techniques for stripping wood are discussed under the heading "Walls: Wood.") Or, you can arrange to have the door dipped, as described for front doors in Chapter 4. If the house is in the First Bay Tradition style, you may choose to leave the natural wood exposed, using an oil finish or clear varnish.

If it is appropriate to repaint a painted door, use a semi-gloss latex enamel, as described under "Walls: Paint." Prepare the surface by lightly sanding to assure adhesion, and fill nicks and gouges which mar the surface with wood putty.

If the panel door is missing or broken beyond

repair, replace it with a panel door that suits the style of the house as indicated by other panel doors, or trim designs still in place. You may be able to relocate a closet door for use to better advantage as an entry door. Otherwise, go to a salvage company. At Campanella, in Oakland, a 5 panel interior door costs \$15-\$25, and a 4 panel door, \$45. Other sources are Berkeley Architectural Salvage and Omega Salvage. Before you go to the salvage yard, jot down the dimensions of the door opening, from the inside of the hinge jamb to the inside of the latch jamb, and from top to bottom. A door that appeals to you and suits the house but is too large by 2" or less can be planed down to fit.

New panel doors, manufactured by Oakland wholesalers Western Door and Sash, can be ordered through any local lumber yard. There are five different styles. The F66, for example, a 1" hemlock door with six raised (beveled) panels, is in stock at C. Markus Hardware, for about \$85. For the sake of comparison, solid core interior doors cost about \$50 and hollow core doors about \$30, with the price depending on the species of wood.

PANEL DOOR REPAIR

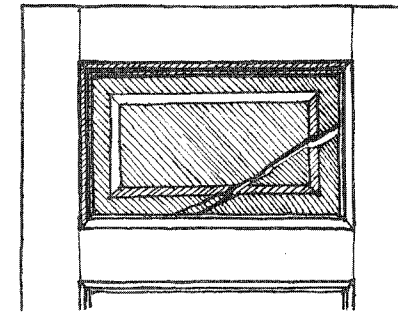

- REMOVE DOOR.
- CAREFULLY WORK A PRYBAR BETWEEN TOP RAIL & STILE. PRY OFF STILE GRADUALLY, WORKING DOWN ALONG THE STILE AT THE POINTS WHERE IT MEETS THE RAILS.

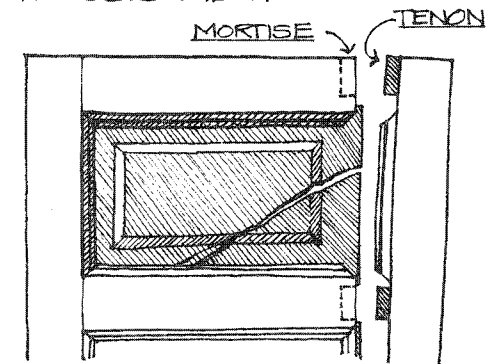

- PRY OFF TOP OR BOTTOM RAIL IF TOP OR BOTTOM PANELS ARE DAMAGED, OTHERWISE REMOVE SECOND STILE ENTIRELY.
- REMOVE DAMAGED PANEL. REPLACE WITH MATCHING PANEL FROM SALVAGE YARD OR LESS PROMINENT DOOR, IF THE PANEL IS FLAT, $\frac{1}{4}$ " FLYWOOD MAY DO AS A REPLACEMENT.
- CLEAN DOWELS OR TENONS AND APPLY A THIN COATING OF WOOD GLUE. RE-ASSEMBLE DOOR, ALLOWING GLUE TO DRY BEFORE HANGING. FASTEN ANY LOOSE MOLDINGS.

TYPICAL PROBLEMS ON INTERIOR DOORS

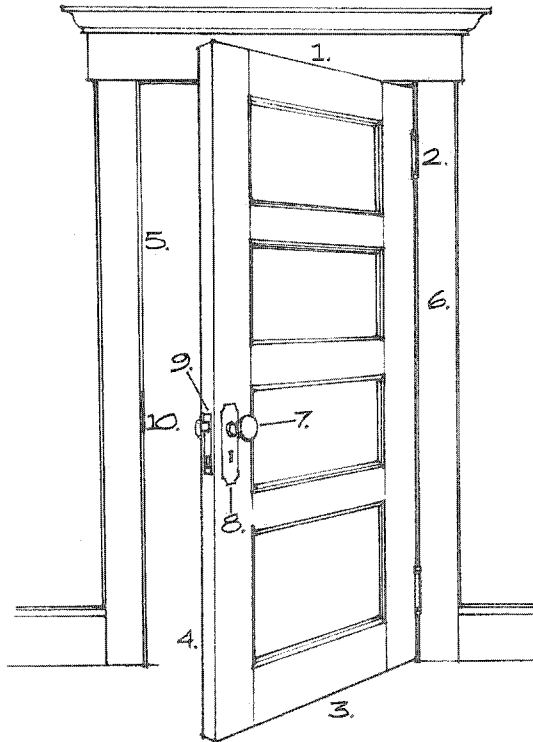

1. EDGES : MAY SWELL.
SOLUTION: PLANING. (DON'T PLANE ON LATCH SIDE)
2. HINGES : CAN CAUSE STICKING WHEN LOOSE.
SOLUTIONS : ADD CARDBOARD SHIMS, REMOUNT SCREWS AFTER PACKING HOLES FOR A TIGHTER FIT, OR SET MORTISES DEEPER.
3. BOTTOM : MAY SAG (BIND) ON LATCH SIDE.
SOLUTIONS : SHIM OUT BOTTOM HINGE, RESET SCREWS OF TOP HINGE, OR DEEPEN MORTISE OF TOP HINGE.
4. DOOR PLANE : MAY WARP
SOLUTIONS : TRY HOME REPAIR BOOK METHODS TO STRAIGHTEN, RESET STOP, REPLACE DOOR.

5. STOPS : WARPED DOOR OR STOP
SOLUTION: MOVE STOP
6. DOOR JAMB : MAY SHIFT DUE TO SETTLEMENT OF HOUSE.
SOLUTION: WORK ON DOOR ITSELF, NOT DOORJAMB.

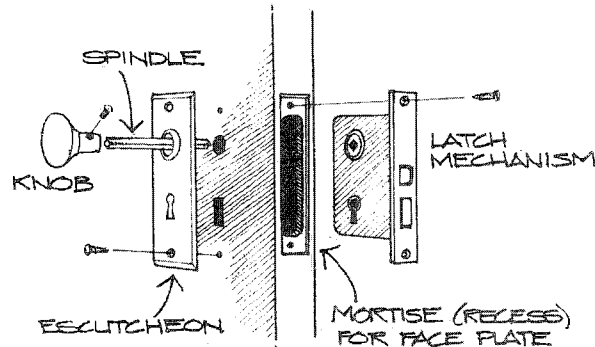

7. KNOBS : KNOB MISSING OR REPLACED WITH ONE INAPPROPRIATE TO DOOR & HOUSE
SOLUTION : FIND KNOBS MATCHING OR IN CHARACTER WITH ORIGINALS. OR, USE KNOBS FROM LESS CONSPICUOUS LOCATIONS SUCH AS CLOSETS.
IF KNOB IS JUST LOOSE : TIGHTEN MACHINE SCREW THAT HOLDS KNOB TO SPINDLE (OBTAIN REPLACEMENT IF SCREW IS STRIPPED OR MISSING).
8. ESCUTCHEON : MAY BE TARNISHED OR PAINTED (ALSO HINGES, KNOBS FACE PLATES & STRIKE PLATES).
SOLUTION: USE PAINT REMOVER (TAKE OFF OF DOOR FIRST) & BRASS POLISH. REPLATE IF NEEDED.
9. LATCH MECHANISM : CAN HAVE MECHANICAL MALFUNCTIONS.
SOLUTIONS: CLEAN & OIL. IF THIS FAILS, CONSULT A LOCKSMITH OR FIND AN OLD LATCH THE SAME SIZE WHICH WORKS.
10. STRIKE PLATE : MAY BE OUT OF ALIGNMENT WITH LATCH, PREVENTING PROPER CLOSURE.
SOLUTION: ENLARGE MORTISE ENOUGH TO MOVE STRIKE PLATE UP OR DOWN AS NEEDED.

Doorframe

The doorframe is as much a part of the doorway as the door itself. The style of the trim goes with the design of the door so it should always be left in its original form, repaired or replaced as necessary. Doorframes, like other types of architectural trim, are constructed of components. The Victorian examples are often quite elaborate, the Colonial Revival style, refined, and the First Bay Tradition, straightforward. Often the design of the door and frame is held over from the preceding architectural styles, so it is not uncommon to find Victorian doors and frames in Colonial Revival houses and Colonial Revival doors and frames in Craftsman houses.

The doorframe is a good opportunity for embellishment. A simple doorway can be made much more interesting by the simple and sensitive addition of a door cap on the head trim, or an extra strip of molding on the jamb. Make sure the embellishments are in keeping with the trim style in the room, and the general character of the house. Use the exterior window ornament, for example, as a guideline on a Victorian house. Refer to the sections "Walls: Wood" and "Walls: Trim" for additional information on sources of molding and creative ways to combine standard parts. See especially the illustration "Adding a Window Cap" as the technique is equally applicable to the doorframe. The windowframe and doorframe should be embellished at the same time. Doorframes are available at Bartley Milling Company, Oakland.

Hardware

Like the door and the doorframe, the hardware original to the panel door is architecturally valuable for its appearance and economically valuable for its material. Original knobs and hinges should always be retained, yet, like the door and the doorframe, the hardware is often needlessly plundered in the name of modernization. Do not replace a fine brass, brass-plated, or glass doorknob with an ordinary cylindrical handle. A latch that malfunctions can usually be repaired by a locksmith. Make sure to check the alignment of the strike plate before faulting the latch mechanism.

VICTORIAN DOORS

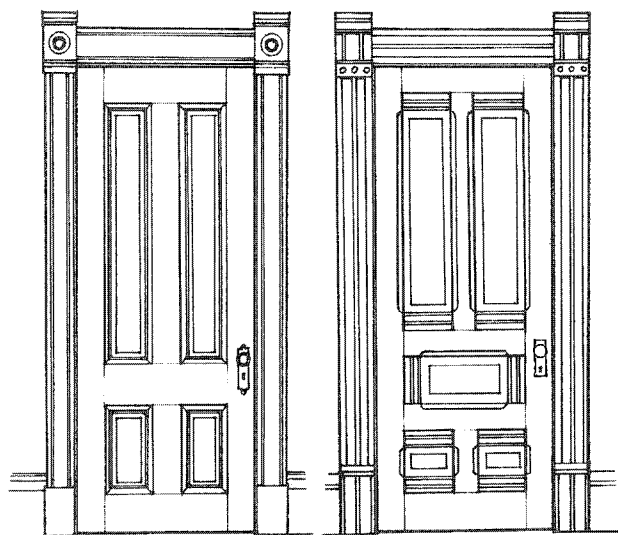

VICTORIAN DOORS ARE PANEL DOORS WITH A VERTICAL EMPHASIS. THEY DISPLAY SUCH A VARIETY OF MOLDINGS AND EMBELLISHMENTS THAT IT IS HARD TO ASSIGN SPECIFIC DOORS AND DOOR-FRAMES TO EACH RECOGNIZED VICTORIAN ARCHITECTURAL STYLE.

DOORS WITH VERTICAL PANELS WANED IN POPULARITY AFTER THE VICTORIAN ERA AND THE HORIZONTAL PANEL DOOR, COMMONLY WITH FIVE PANELS, WAS THE DOMINANT FORMAT DURING THE CRAFTSMAN PERIOD. THE FIVE PANEL DOOR YIELDED TO THE SINGLE PANEL DOOR ABOUT 1915. RUSTIC DOORS OF VERTICAL BOARDS, FOUND IN PERIOD REVIVAL HOUSES, WERE AN EXCEPTION TO THE PANEL DOOR TREND WHICH ENDED WITH THE PROLIFERATION OF FLUSH DOORS IN THE 1940'S AND 1950'S.

If the latch is diagnosed as beyond repair, then try salvage yards, antique stores, or specialty shops. Sometimes locksmiths are privy to desirable doorknobs sacrificed by customers less enlightened than you. The design of a replacement knob or hinge should be consistent with other hardware in the room, if possible. You may choose to swipe a doorknob from another, less obvious location, like the inside of a closet door.

When remounting door hardware, use solid brass screws to remount brass or brass-plated hardware. Likewise, use bronze finish screws for bronze hardware. Refer to Chapter 4, "Front Door: Hardware" for a discussion on the improvement and care of brass or brass-plated door hardware.

FIREPLACE

Throughout history, the hearth has been a romantic symbol of the happy home, a warm fireside that beckons the world weary. As such, the fireplace is an architectural feature valuable for the sensual enjoyment it offers as well as for the visual focus it provides.

An attractive and functional fireplace definitely adds resale value to a house. Some realtors estimate as much as \$5000. Do not board up an old fireplace in an attempt to modernize. To do so drastically alters the character of the room, needlessly sacrifices an economic asset, and otherwise deprives your family, and future residents, of creature comfort, not to mention a hitching post for Christmas stockings. Besides, in these days of energy conservation, what could be more "modern" than an auxiliary source of heat?

Exterior Appearance

Style

The style of the fireplace is dictated by the architecture of the house. It could even be said that the fireplace sums it up, since the features prototypical of the building design—proportion, mass, materials, and ornamentation—are incorporated in the mantel, surround, firebox, and hearth. If the original fireplace is intact, keep it by all means. If the original mantel, surround or hearth are missing or irreparably damaged, replace them in a manner sympathetic to the architectural character of the house.

Basically, there are two kinds of fireplace designs: the **built-in mantel** and the **add-on mantel**. The latter is typical to Victorian houses. During construction, a hole would be roughed in the wall, a

firebox, damper and flue installed, and the surround surfaced with fire resistant tile. Only much later, was the mantel added on. Thus the Victorians could select whatever mantel design appealed, as if choosing a piece of furniture.

The echo of the house's other architectural features notwithstanding, mantel designs were varied indeed, thanks to the assortment of construction materials, mail-order catalogs, and the Victorian esthetic. The earliest examples were carved from marble, but this costly stone was soon replaced with its economic counterpart, slate. By the 1880's, carbon copies of the marble mantels were hewn from wood. In San Francisco Stick style houses, an elaborate overmantel with mirrors and what-not shelves was incorporated in the fireplace design. The distinct disadvantage of the add-on method is that it facilitated removal of mantels in subsequent years by misguided modernizers and well-informed vandals.

Most Victorian fireplaces were the primary heat source and generally burned coal. With the introduction of central heating, fireplaces were redesigned as an auxiliary heat source. They were made larger to accommodate wood as fuel, and the mantels were built in. In Colonial Revival houses, both this and the earlier type can be found. The predominant mantel design is a pair of classic columns with a pediment on top, in a darkly stained or painted wood.

The built-in wood burning fireplace is a hallmark of First Bay Tradition houses. Typically, the mantel is flanked by built-in bookcases, with glass doors, and the stack by a pair of fixed windows, often leaded or stained. The hearth is made of brick, or square tiles in gray, tan or brown. The mantel may be built entirely of clinker brick or it may be wood, with the hearth tiles incorporated as the surround. To determine whether the wood was originally painted, look at the abutting cabinet shelves. If their undersides are painted, the mantel usually was also, and the wood probably does not warrant stripping.

The fireplace is essential to the interior of the Period Revival house because it helps to carry out the fanciful architectural theme. Again, the mantel is built

INSTALLING AN ADD-ON MANTLE

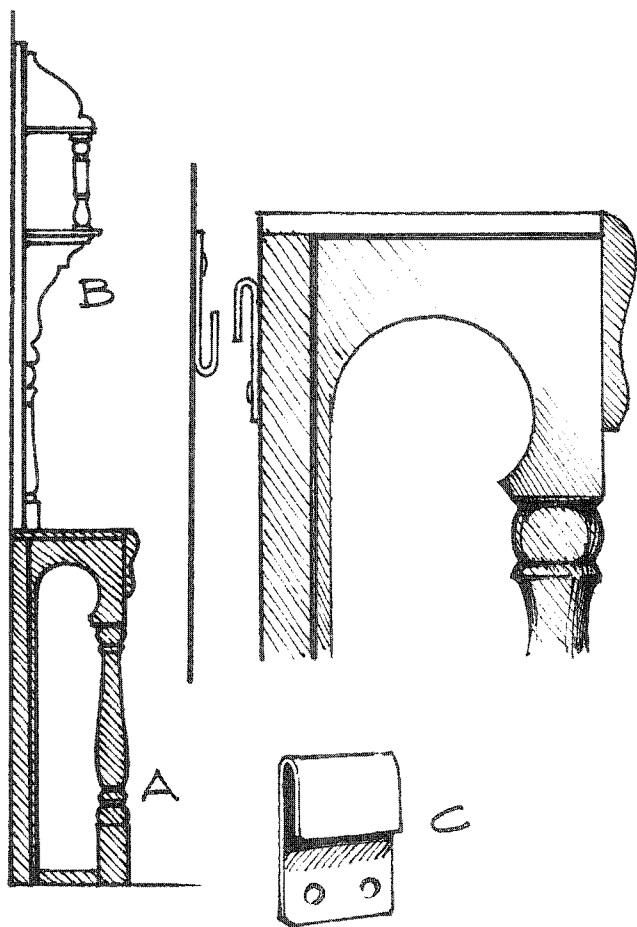

ADD-ON MANTELS (A) AND OVERMANTELS (B) CAN BE SECURED TO THE WALL WITH FLAT HOOKS (C). USE 2 OR MORE SETS OF HOOKS. PATIENCE AND CAREFUL MEASURING ARE NEEDED TO INSURE THAT THE MANTLE WILL JUST REACH THE FLOOR.

in. In fact, it is so ensconced in a massive silo of stucco that it is a protuberant continuation of the wall. The hearth and surround may be tile, rough stones, or brick laid in the herringbone pattern. The stack, and the walls to either side, have arched, recessed niches, or else darkly stained wood beams to reiterate half-timbering elsewhere in the house.

On the Wartime Tract house, the bulk of the fireplace structure is outside the building, as seen in the drawing in Chapter 2. The brick facing, and the wood ledge that constitutes the mantel, project no more than the depth of a brick into the living room. The forms are simple and rectilinear, and the brick is often painted.

Repair

To replace a missing add-on mantle, scavenge salvage yards, and because mantels are becoming something of a collector's item, peruse antique shops. Painted mantels, with beveled glass, cost about \$100 - \$150 second hand at Sunrise Salvage. Natural wood mantels run about \$150 - \$250, thereby rewarding the painstaking stripper. As long as the design is architecturally sensitive, there is no need to duplicate the original precisely. The selection of the original add-on mantle was a matter of the first owner's taste, and so the replacement may be of yours.

New wood mantels with legitimate old designs are sold at San Francisco Victoriana. Prices begin at \$400 for the mantle itself, \$1,000 for the overmantel. For those who are "just looking," a catalog of mantle designs authentic to each of the Victorian periods is available for free consultation at their sales counter.

To reconstruct a damaged built-in mantle, consult a cabinet maker, or do it yourself. Erect a simple wood box, with a ledge on top, and chamfered corners perhaps. For ornamentation, add standard molding, separately or in creative combinations, as explained in the section "Walls: Trim." To incorporate hearth tile in the mantle ornamentation, cement it in place with a product suitable for wall tiles, and frame it with moldings.

While a reproduction of the original mantel is not essential for a well-designed result, a reasonable facsimile entitles you to the rules of applicable code. (Consult Chapter 3.) In contrast, a redesigned rebuilt mantle must conform to modern standards established by the *Oakland Building Code*. Its requirements, however, do not preclude an architecturally sensitive replacement. For example:

- Clearance of at least 12" between the fireplace opening and any combustible materials. (In other words, a facing 12" wide of fire resistant brick or tile between the fireplace opening and the wood mantel.)
- Hearth dimension of no less than 20" in front and no less than 12" to either side of a fireplace opening that measures six square feet or more; hearth dimension of no less than 16" in front and 8" to either side of a fireplace opening less than six square feet.

Whether replacing or rebuilding a mantle, follow these design guidelines:

- The size of the mantle should be in proportion to the shape of the room and to the size of the fireplace opening.
- The woodwork, tiles, and trim should be consistent with the other decorative motifs in the room and on the house.
- The size of the fireplace opening should never be changed for esthetic purposes only. (See below).

If an existing fireplace was thoughtlessly painted, the paint can be removed from tile, marble, stone and wood by the stripping techniques described under "Walls: Wood." If clinker brick has been painted, the only effective solution is sandblasting, and regrettably so. Even though sandblasting equipment can be rented (\$126.50 a day at Carter's Rental, Berkeley), the process engenders an incredible mess, and threatens surrounding wood and plaster with pockmarks. Natural brick should never be painted as painting it, for all practical purposes, is an irreversible action.

To remove soot stains from brick, tile, or stone facing, use detergent and water. For stubborn stains, a solution of water and muriatic acid, half-and-half,

RESCUING A REMODELLED MANTLE

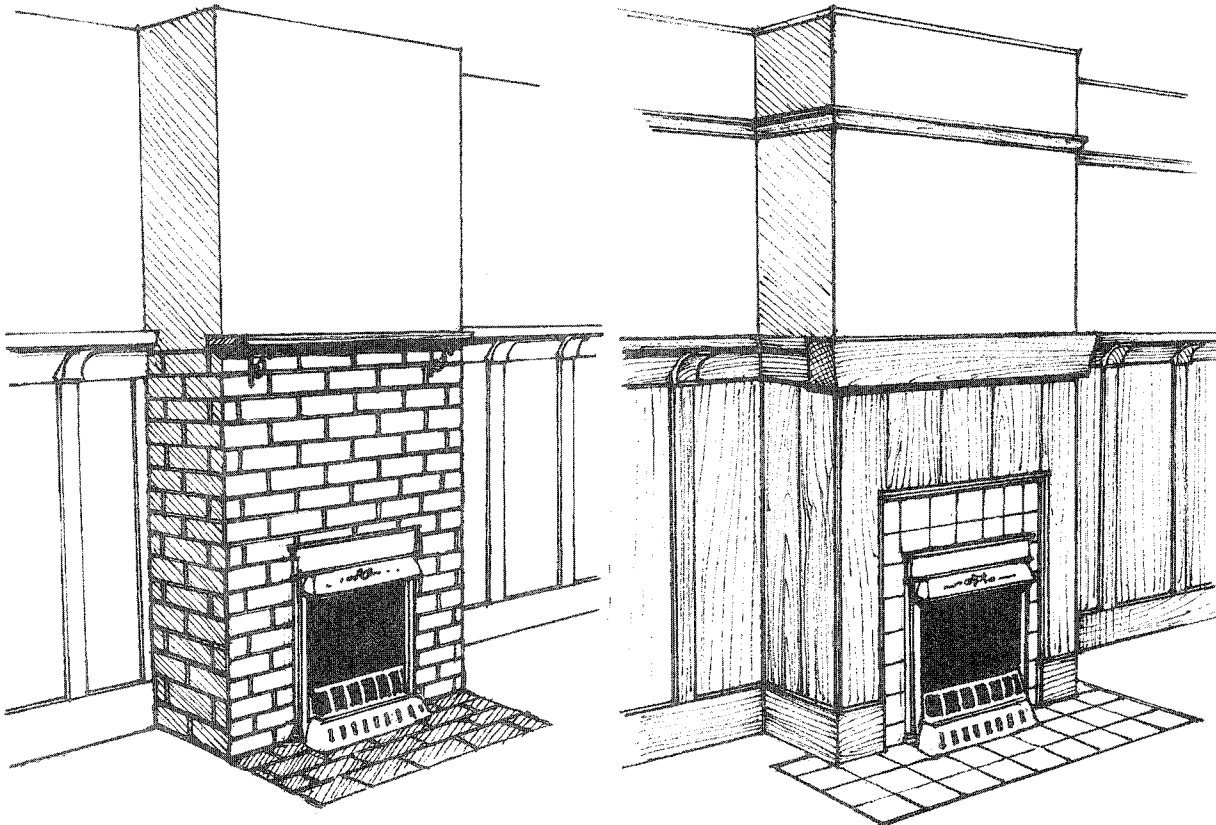

IN THIS MISGUIDED REMODELING EFFORT, IMITATION BRICK HAS BEEN APPLIED, A SKIMPY MANTEL REPLACES THE ORIGINAL AND THE REMAINING PANELLING HAS BEEN PAINTED AND THE CORNICE REMOVED. OTHER TECHNIQUES ARE USED TO ALTER FIREPLACES BUT LOSS OF CHARACTER OFTEN RESULTS.

RESCUING THE FIREPLACE FROM THIS SADLY COMMON DISGUISE ENTAILS REMOVING THE BOGUS MATERIALS AND ADDING MANTEL, BASEBOARD, AND CORNICE MOLDING WHICH MATCH THE SURVIVING CRAFTSMAN PANELLING IN PROPORTION. (STRIP THE PANELLING FIRST). UNGLAZED TILE IS USED FOR HEARTH AND SURROUND.

should do, but gloves and eye protection are a must.

Internal Workings

A fireplace in poor repair constitutes two very serious hazards. Insufficient draw permits smoke to fill the room and deoxygenate the breathing air. Poor draw may be the result of a blocked or sooty flue, a faulty damper, or an ineffectual ratio of fireplace opening to flue size. It usually takes only a small newspaper fire to identify this problem. Make certain the damper is operative first, and open it.

A leaky flue may allow sparks or flames to contact the building's structural frame and ignite the wood. Leaks result from cracks in the flue liner, crumbling mortar, missing bricks, and the separation of the fireplace from the chimney as a result of settlement. Since accumulated soot is combustible, a dirty chimney sets the stage for a flue fire. Look for these symptoms of a situation susceptible to a flue or structural fire:

- separation of hearth from floor plane
- separation of mantel from the wall, as little as 1/8"
- no daylight visible up through the chimney (use a mirror to reflect the rays)
- accumulated soot in the throat of the chimney (use a flashlight).

Unfortunately, the City offers no inspectional services to specifically evaluate fireplace safety. Professional consultation and service (listed in the *Yellow Pages* under "Chimneysweep" and "Fireplaces") are available and advisable for the more sophisticated operations associated with fireplace repair, like replacing a flue lining. Detecting hazardous problems and correcting insufficient draw requires deftness and equipment as well as expertise. Before hiring a fireplace firm, make sure they have damage and liability insurance. Chimney dust is extremely fine, and can permeate a house if mis-handled. Also confirm a contractor's license if structural work is involved. (See Chapter 3.)

Repair of the internal working order of a fireplace can be accomplished without disturbing the original exterior appearance. Home repair manuals offer basic instruction in pertinent tech-

PARTS OF A FIREPLACE

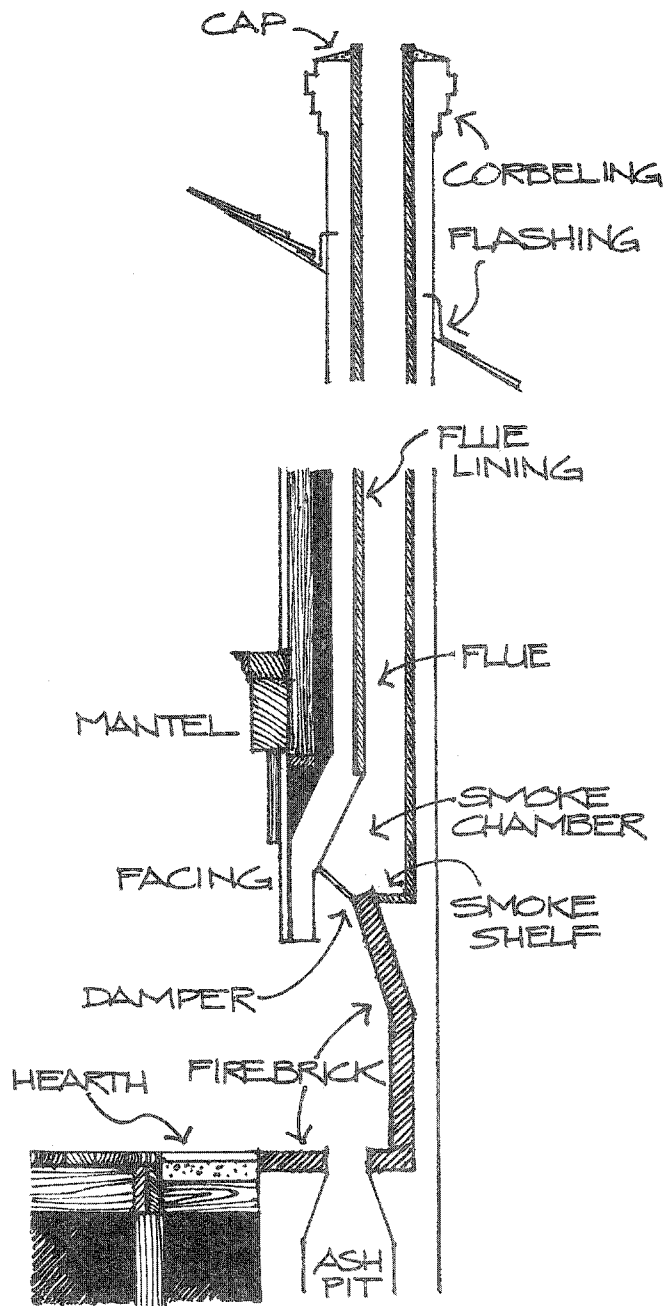

niques, such as installing firebrick and repointing fireclay. The May 1, 1977 issue of *The Old-House Journal* has a thorough discussion of other technical problems.

Never enlarge a small fireplace opening if the flue size is to remain the same. The proportion of the flue size to the fireplace opening is a critical factor for successful draw. The rule of thumb is that the fireplace opening should be not more than 10 to 12 times the area of the flue opening. (For example, a fireplace has an existing flue measuring 9" x 12", or 72 square inches. By the guideline, the fireplace opening should be 36" by 24", an opening of 864 square inches, or 12 times the flue.) Additional axioms for good draw are: width greater than height, and depth at least two feet. Enlarging a fireplace opening but keeping the original size flue is asking for draw problems.

Do not be frustrated by the limited size of a small Victorian fireplace. It can be used for burning wood as long as the logs are chopped to fit, burned in reasonably small quantities, and the rest of the fireplace mechanisms are in working order. Better yet, use coal, the fuel the fireplace was originally intended for. A 100 pound sack costs \$6.50 at Larm's Building Materials in Oakland.

It is possible to correct draw problems by reducing the size of a fireplace opening and improving its ratio to the flue. Experiment by lining the bottom, sides, or back of the firebox with firebrick but without mortar. When you discover the configuration that works best, make the installation permanent with fireclay. For new fireplaces, the *Oakland Building Code* requires that the firebox be at least 20" deep, with top, bottom and side walls made of at least 4" of firebrick backed by at least 4" of common brick, and fireclay joints 1/4" thick.

Never place a gas heater in the fireplace, nor direct its gas vent through the chimney. This is dangerous, illegal, and architecturally inappropriate. (Consult "Utility Systems: Mechanical.") Call the City's Inspectional Services Department for information on mechanical permits necessary for the installation of a gas heater. If this condition exists, consider relocating or replacing the gas heater and restoring the fireplace.

The chimney itself may not be structurally sound, as evidenced by leaning, separation of the chimney from the house, cracks, crumbling mortar and loose bricks. Consult Chapter 4, under "Roof: Chimney," and a standard home repair book.

When preparing to buy a house, evaluate the condition of the fireplace and estimate the cost of repair prior to agreement on the sales price. The cost of making the fireplace operative can be a factor in negotiating the deal, much as the cost of termite repair is.

To clean a chimney, call a chimneysweep. Chimneys need cleaning every 15 or 20 years to optimize draw and minimize the danger of a flue fire, but most chimneys have never been cleaned at all, according to an Oakland fireplace specialist. The going rate for a one-story chimney is \$45, and for a two-story chimney, \$65.

STAIRCASE

Think of the amount of space a staircase takes up in a two-story house, and the quantity of materials. Why, it's easily as important as an entire room, and probably more so because it can be seen from so many angles, and it is *sine qua non* of circulation. The staircase structure and ornamentation are unique within the house. When improvements are made, the original combination of function and decoration should be respected, and wherever possible, retained.

Style

In two-story Italianate and San Francisco Stick style Victorians, the staircase is straight and narrow, running the length of the entry hall. To maintain the tall, thin proportions of the architectural style, and to traverse the considerable vertical distance from first to second floor—remember the 12 foot ceilings—the risers are especially high and the treads short. In the large Queen Anne house, the entry hall merged with the living area and the stair sequence became a focal point. It assumed a square configuration, the direction of the steps doubling

back at a landing midway up the flight. Victorian stairways are distinguished by turned balusters, one or two per tread, carved spandrels, and substantial newel posts. Often the partition wall concealing the stringers is surfaced with lincrusta-Walton.

During the Colonial Revival era, the landing at the kink in the staircase was elaborated upon, with built-in benches, hidden storage, and stained glass windows. The balustrade, simpler than the Victorian and more classical in detail, was often, but not exclusively, painted. The staircase is faced with wainscotting, like the other walls within view.

On large Brown Shingle and Prairie School houses, the balustrade derives its decorative aspects from the structure itself. The wood is natural, the lines are simple, and the forms massive. There is typically one baluster per tread, and it is rectangular in profile. Craftsman wainscotting covers the open-stringer side.

Repair

The question of applicable code, introduced in Chapter 3, is especially pertinent to the repair or reconstruction of staircases. As interpreted by the City, repair means to replace treads, risers or handrails. To rebuild means to replace the entire works, including the structural support, called stringers or horses. The Inspectional Services Department generally advises that for purposes of safety, rebuilt stairs be constructed to modern standards, since staircases are a common location for household falls. Fortunately for the architecture, however, reconstruction to modern code is not required.

Thanks to a recent amendment to the *State of California Health and Safety Code* (by Senate Bill 2348) owners of single-family and duplex dwellings are entitled to the replacement, retention and extension of original materials and the use of original methods. **If you want to rebuild the staircase exactly as it was**— even if the risers are too high, the treads too short, or the width too narrow, according to the *Uniform Building Code*—you can. No variance is necessary.

The law, however, does not permit any changes in

the design unless those changes meet modern code standards. For example, a staircase that originally had 9" risers could be completely rebuilt and still have 9" risers, even though today's code establishes a maximum of 8" risers for new construction. But, it would not be permitted to rebuild the same staircase with 8½" risers as this is neither original, nor in conformance with the code.

Rebuilding a complete staircase is a sophisticated job for an amateur. If you are game, thorough guidance can be found in the *Stair Builders Handbook* by T.W. Love, available at the Oakland Public Library. If you hire a contractor or a carpenter, make certain your intentions to retain the original staircase design and ornamentation are quite clear before work begins.

When dismantling the remains of an expired staircase, keep the valuable component parts (the baluster, handrail, spandrel, wainscotting) for re-use as is, or as samples for replication. Once the support structure of the staircase is rebuilt, the more superficial parts should be replaced exactly as they were originally—this is easy if you were able to salvage them—or as sympathetically as possible. Always maintain the original proportions and materials, even if the design does not duplicate the original.

It is likely that part of the staircase may need repair, even if the whole structure need not be rebuilt. The balustrade is a likely spot for problems. It may be wobbly, damaged, or missing altogether. (Balustrades are a popular item with knowledgeable vandals.) The newel post is the anchor of the balustrade at each story and at the landing, so it must be securely attached for the balustrade to be sturdy.

To tighten a loose baluster, drive wedges into the gap between it and the handrail. Begin with a strip of hardwood, slightly larger than the gap. Sand or plane it into a wedge shape, with the grain running the length of wedge. When the size is right for a snug fit, coat the wood strip with glue and tap it into position. Another technique is to drill a hole through the post at an upward angle toward the rail. Drive a screw, and countersink it.

A baluster can be removed in order to strip the

PARTS OF A STAIRCASE

A. CLOSED STRINGER
FREQUENTLY, THERE ARE 2 CLOSED STRINGERS. THE GROOVES THAT HOLD THE TREADS AND RISERS ARE SHAPED TO ALLOW THE INSERTION OF SECURING WEDGES.

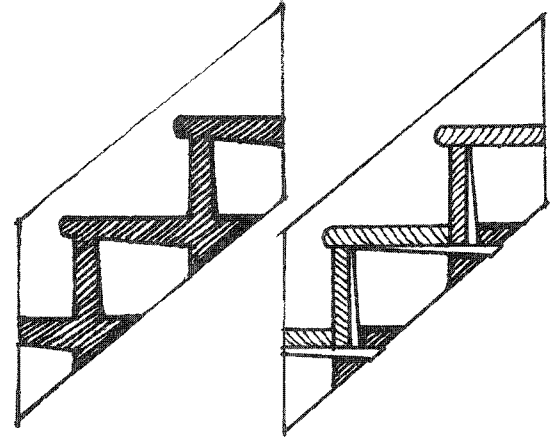

B. A WOODEN BEAM IS SOMETIMES USED AS A CENTER STRINGER, EMPLOYING SECTIONS OF 1x6 BOARDS TO BRACE THE TREADS.

C. OPEN STRINGER

D. TREAD

OFTEN TREADS AND RISERS ARE MORTISED FOR A CLOSE FIT (SEE STAIR CARPETING ILLUSTRATION).

E. NOSING

THE PART OF THE TREAD THAT PROJECTS BEYOND THE RISER.

F. RISER

G. HANDRAIL

H. BALUSTER

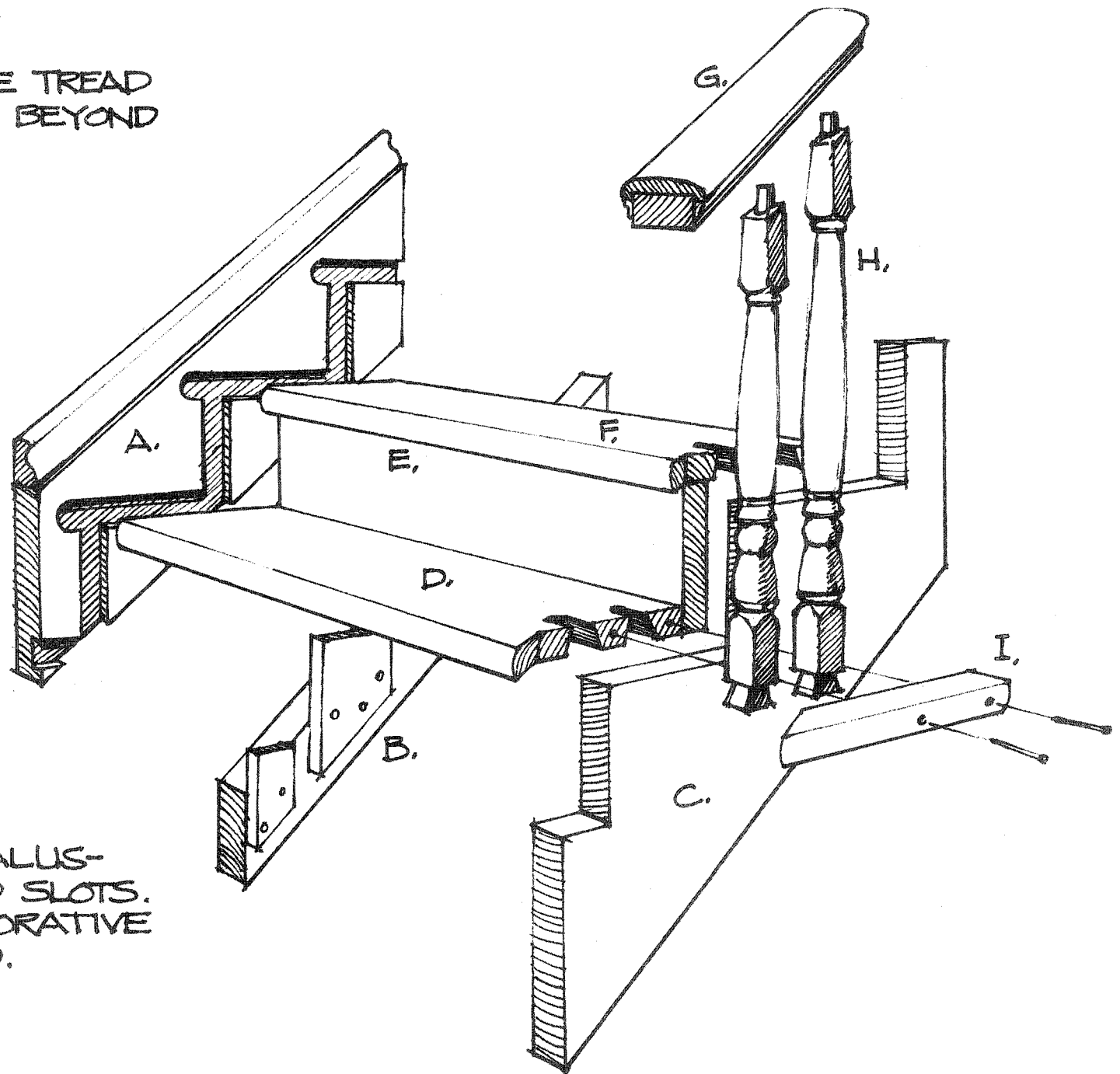

I. END TRIM

HELPS HOLD BALUSTERS IN TREAD SLOTS. PROVIDES DECORATIVE EDGE TO TREAD.

NEWEL POST

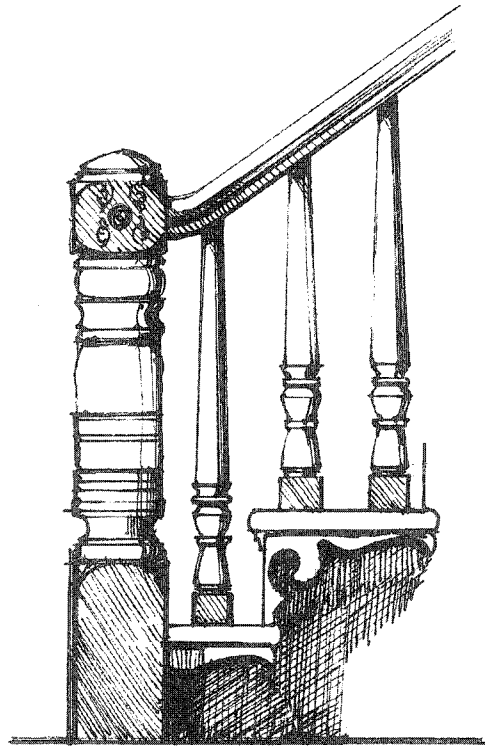

NEWEL POSTS ARE THE OFTEN HEAVILY ORNAMENTED POSTS WHICH ANCHOR THE ENDS OF THE HANDRAIL, SPANDREL ORNAMENTS ADORN THE AREA UNDER THE TREAD END TRIM.

paint, or for use as a pattern to make replacements. Typically, the bottom of the baluster fits into a slot in the tread, and the top into a hole on the underside of the railing. Pry off the end trim on the tread in order to slide the baluster out of its slot. Then pull down to free the top from the handrail.

To reproduce missing turned balusters, a lathe is essential. Equipment and instruction are available at the evening adult school in Piedmont. (See Chapter 6.) If most or all of the balusters are missing, you may select a different but compatible design that is easier to build in multiples. Craft a flat baluster that retains the silhouette of its more shapely ancestor, or construct a simple composition of standard geometric pieces and moldings that retains the proportion of the original posts. (Refer to Chapter 4, "Porch: Railings.") If the handrail needs replacement, it too can be rebuilt in character by combining standard pieces of lumber and molding. (Consult Chapter 4, "Stairs: Handrails.") New handrails can be ordered from the Bartley Milling Company, Oakland.

To replace missing balusters, scour salvage yards for a matched set. Or, arrange for a new group to be crafted by a local carpenter or mill yard. One source for new balusters is Haas Wood and Ivory Works, 64 Clementina, San Francisco. **Never substitute a prefabricated wrought iron unit for an original wood balustrade.**

If the balustrade is natural wood, leave the grain exposed. If it is already painted and needs a new coat, refer to "Walls: Paint" for advice on color and product selection. Before re-painting, it may be necessary to scrape or strip at least the surface layers of accumulated paint in order to uncover the real form of the wood elements underneath.

When it comes to surfacing the staircase, the **intriguing sequence of right angles** that epitomizes the structure should be shown off. The obvious way is to leave the wood exposed, but even if the stairs are to be carpeted, the configuration of step and nosing need not be obliterated. By selecting a carpeting with a short, dense pile and a minimum of padding underneath, the carpeting can be contoured to the shape of the step and the architectural angles captured.

STAIRCASE CARPETING: DO'S AND DON'T'S

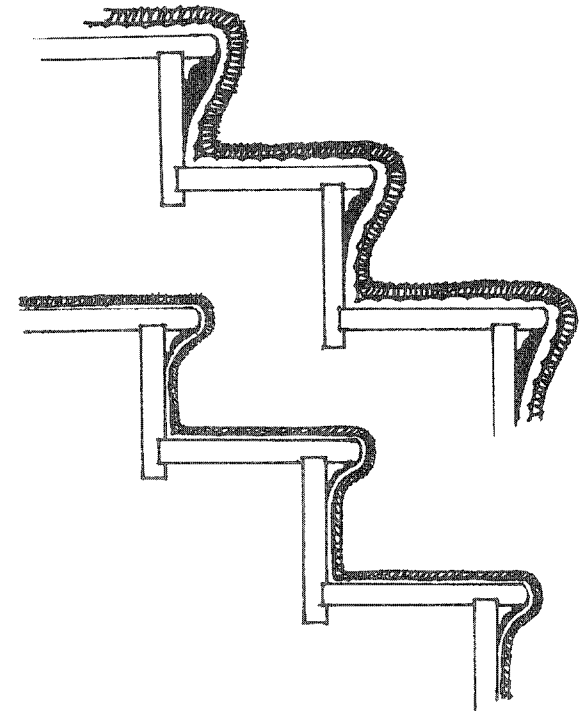

SHAG OR DEEP-PILE CARPETING COUPLED WITH A THICK PAD (TOP SKETCH) CAUSES A LUMPY, OVERSTUFFED LOOK OUT OF CHARACTER WITH EARLY STAIRCASES DESIGNED FOR RUNNERS. THINNER BUT DENSER CARPETING WILL STILL WEAR WELL (LOWER SKETCH) WHILE RESTORING VISUAL DEFINITION TO THE NOSING.

UTILITY SYSTEMS

Electricity, heating, and plumbing are the central nervous system of the house. Subject to continual use, older systems are susceptible to breakdowns; victims of progress, they are likely to become outmoded by the conveniences which typify modern living. This section does not provide specific instructions for the repair or upgrading of a building's infrastructure. Rather, it is an aid to evaluating the systems that are there, and to improving them without disastrous effects on the architecture.

Electricity

To begin to understand the way the electrical system in your house is put together and recognize its shortcomings, become conversant with some basic vocabulary. Electricity is moved through wires by pressure, much the way water is moved through pipes. The amount of pressure is called **voltage** and it is measured in units called **volts**. **Current** is the rate at which electricity is delivered—to the house from the power pole or to an individual appliance from the wall socket—and it is measured in amperes, commonly referred to as **amps**. The voltage forces the current along the electrical wires. The amount of current that can be transported is determined by the diameter of the wire.

The route of the wiring is called the **circuit**. Typically, several fixtures and sockets share a circuit, while heavy duty appliances, like refrigerators or washing machines, have a circuit all their own. Each circuit is protected from overload by its own fuse or circuit breaker. The **fuse** contains a strip of soft metal which is melted by excessive current. The **circuit breaker** has a spring which is activated when excessive current passes through it, and the circuit is broken as if a switch had been turned off.

Service

Service refers to the total amount of voltage and amperage available to a house, and to the number of wires which carry that electrical power from the transmission pole to the meter box on the building.

IDENTIFYING YOUR ELECTRICAL SERVICE

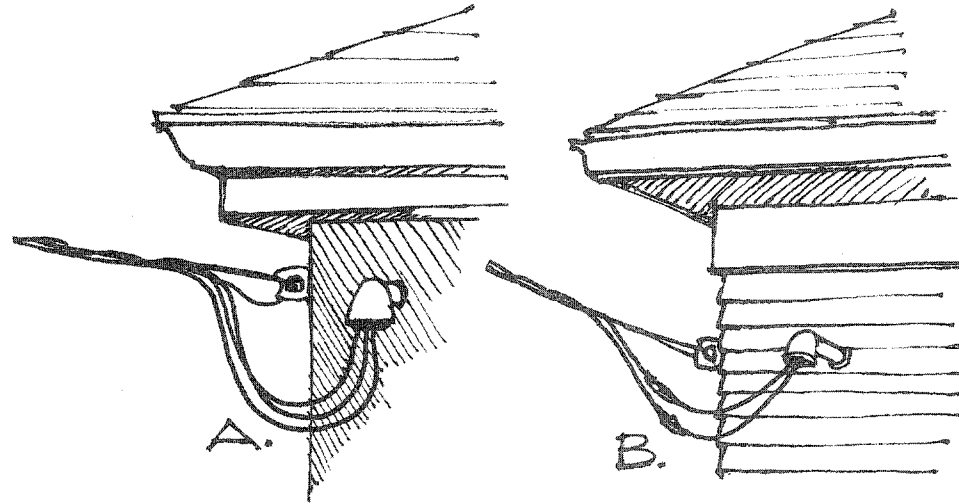

A BRIEF LOOK AT THE ELECTRIC POWER HOOKUP WHERE IT ENTERS THE HOUSE CAN TELL YOU THE VOLTAGE OF YOUR SERVICE BUT NOT THE AMPERAGE (AMOUNT OF CURRENT) AVAILABLE. A 3 WIRE HOOKUP (SKETCH A) INDICATES 110-220 VOLT SERVICE. THE AMPERAGE MAY VARY FROM 30-100 AMPS. 2 WIRES (B) MEANS 110 VOLT SERVICE THAT MAY BE 20 OR 30 AMPS. WIRE SIZE IS THE KEY TO AMPERAGE. FUSE SIZE AND FUSE PANEL LABELS CAN BE MISLEADING. ASK AN INSPECTOR OR QUALIFIED ELECTRICIAN

In Oakland, most houses built before World War II originally had **two wire, 30 amp, 120 volt service**. Pacific Gas and Electric estimates that 15% to 20% of the single family residences in Oakland (10,800 to 14,500 homes) still do. While this was perfectly adequate for electrical needs when first installed, and may still be for lifestyles with spartan energy demands, two wire, 30 amp service is very limited for today's appliance reliant family. Typically there are only two circuits. The amps on the fuses, combined, must not exceed 30 amps, resulting in combinations of one 10 amp circuit and one 20 amp circuit, or two 15 amp circuits. The amperage is sufficient to allow a refrigerator, television, stereo, hot water heater, and other "basic necessities," but it will not accommodate several small appliances turned on all at once or even one heavy duty appliance.

Another 10% of the single-family housing stock in Oakland (some 7,200 homes) have **three-wire, 120-240 volt, 30 amp service**. Three-wire service more than doubles the electricity available from a two-wire system. It permits at least twice the number of 120 volt circuits and an additional 240 volt circuit. The increased capacity accommodates the simultaneous use of more small appliances, like a kitchen busy at breakfast. However, the low amperage level precludes the use of major appliances, like an electric dryer which alone requires 40 amps, despite the increased voltage offered by the 240 circuit.

P.G. & E. surmises that another 25% of the single-family houses (about 18,000 homes) have **three-wire, 120-240 volt, 70 amp service**. There are enough circuits for all those electrical wedding presents. There is also enough voltage and amperage to support an electric dryer and an electric range.

Postwar houses are normally outfitted with **three-wire, 120-240 volt, 10 amp service**. This level of service is the minimum standard established by FHA and GI housing loans, for new and old houses alike.

Improving the electrical service is one of the most effective ways to modernize an old house without harm to the architecture. It is generally advisable to upgrade 30 amp service, whether two-

wire or three-wire, to 100 amp service. It is generally unnecessary to upgrade a 70 amp system that is otherwise operating safely. The going rate charged by a licensed electrical contractor, with union labor, for increasing service from 30 amps to 100 amps is \$300 to \$375. This includes installation of a new circuit breaker panel, and all the wiring upstream (on the service side) of that point. The additional wiring downstream (on the house side) that makes the upgraded service utilitarian costs roughly an additional \$25 per circuit and \$39 per socket. Downstream work is within the grasp of the electrically knowledgeable homeowner.

Two-wire service, and the original two-wire portion of an upgraded three-wire system, were typically installed by the knob-and-tube method. By this technique a conductor wire wends its way through the house, with a porcelain knob to support the wire where it crosses wood. A porcelain tube encases the wire where it crosses other wire and in vertical runs through wood members.

In modern or modernized residential wiring systems, BX and Romex wire replaced the knob-and-tube method. BX wire encases two wires in an armor shield and Romex wire encases two wires in a non-metallic sheathing. Although BX and Romex are the more-up-to-date methods, **knob-and-tube, properly installed, is a safe and efficient system that does not require replacement just because it is old-fashioned.** However, when extensive problems exist in a knob-and-tube system, it is practically impossible to repair it in-kind because the new, or "good as new" parts required by the electrical code are very difficult to come by.

All new electrical installations must conform with the most recent *Oakland Electrical Code*. **Existing installations are acceptable if they have been safely maintained and the original integrity of that system has not been altered or abused.** Over-fusing for example, is one type of abuse which could very well have damaged the electrical system, whether or not alterations were involved.

If you feel competent enough to do the wiring downstream of the service box yourself, you can apply for an electrical permit. Before the permit is issued, the Inspectional Services Department visits

the house to assess whether or not the homeowner can handle the job. Lack of expertise can be fatal. Electrical malfunctions were the number one cause of fires during 1975 in the United States, according to the National Fire Protection Association.

The proportion of electrical permits issued directly to homeowners has increased to 25% of the total residential work. The electrical inspector makes an average of nine house calls to the do-it-yourselfer, in comparison to three trips to review the professional electrician's work. If you have to be told to **turn off the main power switch before working on the electrical system**, you should probably hire an electrician.

When looking for an electric contractor:

- Always check for a State Electrical Contractor's License, C-10.
- Always get competitive bids in writing.
- Never pay more than 10% of the fee in advance. You are entitled to this limitation by the State Contractors License Law.
- Never make the closing payment until the final inspection is made by the City and the work is approved.

If you sell the house within a year, you are required by Article 7004 of the *Contractor's State License Law* to use a licensed electrical contractor for all work. That way the buyer has recourse should anything go wrong. (Refer to Chapter 3.)

If you are uncertain about the condition of your electrical system, the City will conduct a complete survey and provide a written report for \$16.50 an hour. It usually takes one hour to complete. The report enumerates applicable code violations, inadequacies, and recommended changes. Following the report, the Inspectional Services Department requires that any hazards be corrected but they do not insist that all improper installations be redone according to code.

To do your own survey, make a map of each room in the house, noting the electrical fixtures and outlets. Then, by trial and error, determine which fuse or circuit breaker controls each one. Using a loud portable radio to test the outlets saves trips back

and forth. Assign numbers to the fuses, if there are none on the service panel. Then mark the number of the circuit that controls it next to each fixture or outlet on the plan. Make a reverse list which enumerates all the fixtures controlled by each circuit.

Wiring

When the level of electrical service is upgraded, its time to add new circuits. When the present service is adequate, but inconvenient and under-utilized,

ADDING A WALL SWITCH FOR AN OVERHEAD LIGHT

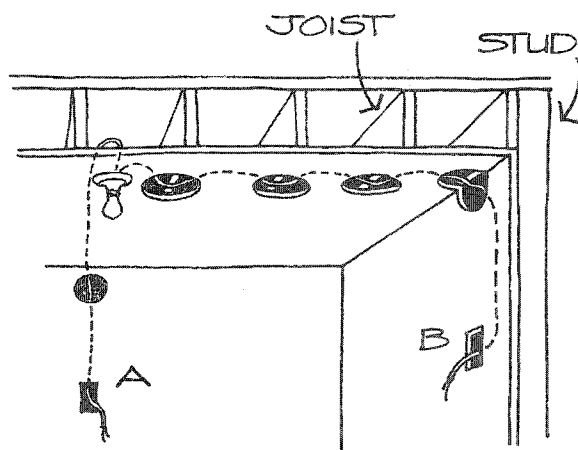

SWITCH LOCATION A.

THIS IS THE EASIEST. WIRING IS RUN IN THE CAVITY BETWEEN JOISTS. ONE HOLE IS MADE TO FISH THE WIRE THROUGH.

SWITCH LOCATION B.

AVOID IF POSSIBLE. A HOLE MUST BE CUT IN THE CEILING AT EACH JOIST TO ALLOW NOTCHING FOR WIRING CLEARANCE.

NOTE: INSTALL PROPER SIZED ELECTRICAL BOXES AT SWITCH AND FIXTURE.

its time to add a new circuit, or at least add a more convenient socket, switch, or fixture to an available circuit. When a portion of an otherwise acceptable electrical system breaks down, its time for repairs. Each one of these situations requires work behind the walls of an existing house, so **wiring becomes a matter of carpentry as well as of electrical know-how.**

The technique used to wire or rewire behind solid walls can have little effect on the architecture, or can totally devastate it. Its up to the homeowner to protect his or her house from the expedient electrician who pokes holes, slashes molding, or recommends ripping out an entire wall. **There is no need to destroy good lath and plaster in order to rewire, nor to gut the innards of a house in order to modernize the electrical system.**

Remember that the more walls that are ruined to make the electrician's job easier, the more difficult and more expensive it will be for you to replace or repair them. **To keep the cost of wall repairs from inflating the cost of wiring, and to safeguard the architecture of the house, follow these guidelines:**

- Lay out the route of the wiring yourself, before the electrician goes to work. Compare notes.
- If one or more walls are slated for repair, take advantage of the exposed frame to accomplish necessary electrical work in that area. Even if the rest of the system will not be completed for some time, install the wires while the wall is open, and cap the ends for future use.
- Whenever possible, route the wire through hidden passages (crawl space, pipe chase, abandoned vents, or the like) instead of through the wall itself.
- For ceiling runs, like wiring an overhead light fixture with a pull chain into a wall switch, send the wire parallel to the joists in the void between them.
- For bottom of the wall runs, like adding a series of convenience sockets, remove the baseboard and scrape a channel in the plaster behind it as a bed for the wire. If the wire is closer than 1" from the surface, code requires that it be covered with a metal plate to protect the wire from pierc-

SOCKET AND SWITCH: DO'S AND DON'T'S

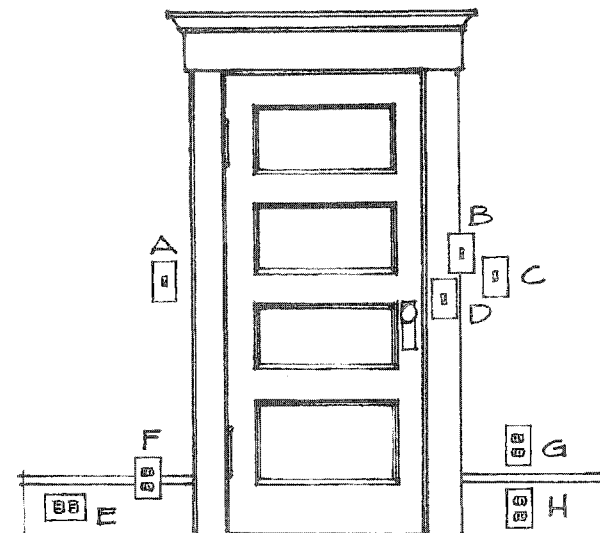

SOCKETS - E & H ARE PREFERRED (CORDS ARE UNOBTRUSIVE, FACE PLATES ARE CLEANED WITH BASEBOARD). G IS ACCEPTABLE, F DEFACES BASE MOLDING.

SWITCHES - C IS THE BEST LOCATION. B & D MAR THE DOOR TRIM, A IS ON THE WRONG SIDE OF THE DOOR SWING.

ing nails. Replace the baseboard after the wire is inspected. Elaborate cornice moldings can hide wiring in a like manner. (See "Walls: Trim" for the best method to remove molding.)

- For first floor sockets, use the open cellar ceiling for the wire, and come up into the room behind the baseboard.
- For vertical wall runs which require notches in obstacles like studs and firestops, use adjacent rooms or closets where patched surfaces are less noticeable, less important, or scheduled for wallpaper.

HOW TO "FISH"

FISHING PREVENTS UNDUE DAMAGE TO WALLS, CEILINGS AND ORNAMENTATION WHEN THERE IS NO EASY WIRING ACCESS. THE FOLLOWING SKETCHES SHOW THE BASIC TECHNIQUE. SOLID BLOCKING ABOVE THE WALL, FIRESTOPS BETWEEN STUDS AND LUMPS OF PLASTER ARE AMONG THE HIDDEN OBSTACLES THAT MAY COMPLICATE AN ALREADY DIFFICULT PROCESS. PARTICULAR PROBLEMS AND VARIANTS ON THE TECHNIQUE ARE COVERED IN BACK ISSUES OF "THE OLD HOUSE JOURNAL".

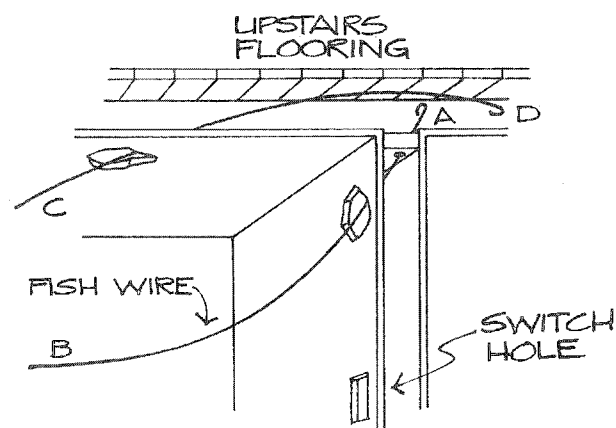

- OPEN A HOLE IN THE WALL 5" OR 6" FROM THE CEILING. WITH AN 1/8" DRILL BIT, MAKE AN ANGLED HOLE INTO THE CAVITY ABOVE THE CEILING. RUN FISH WIRE INTO THE CAVITY FROM THE CEILING FIXTURE HOLE AND THE WALL HOLE. "FISH" UNTIL HOOKED ENDS A AND D INTERLOCK (PERSISTENCE AND PATIENCE ARE NEEDED HERE). PULL ON END C UNTIL A EMERGES FROM CEILING HOLE. ATTACH ELECTRICAL CABLE TO HOOK A, MAKING SURE THE CONNECTION IS NOT TOO BULKY TO PASS THROUGH THE DRILLED HOLE.

PULL ON END B UNTIL THE CABLE APPEARS AT THE WALL HOLE. RUN FISH WIRE UP FROM SWITCH HOLE TO WALL HOLE. FASTEN CABLE TO FISH WIRE AND PULL DOWN TO SWITCH HOLE.

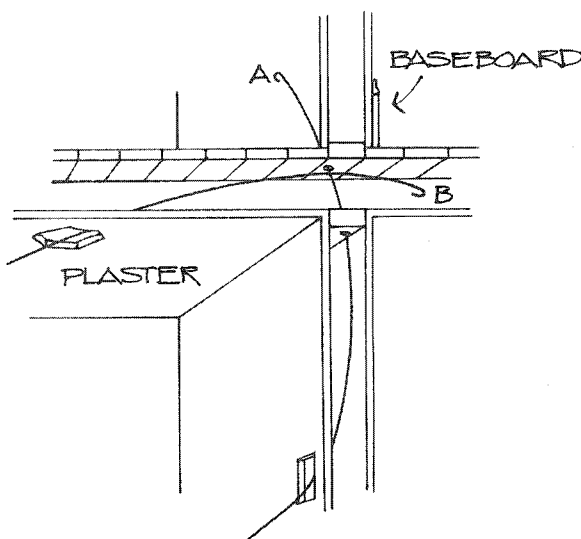

- WHEN THERE IS A WALL DIRECTLY ABOVE THE SWITCH-PLATE WALL, THE EXTRA WALL HOLE IS UNNECESSARY. REMOVE THE UPSTAIRS BASEBOARD AND DRILL AN ANGLED HOLE INTO THE LOWER WALL CAVITY. FEED FISH WIRE INTO WALL AND OUT SWITCH HOLE. PULL END A BELOW UPSTAIRS FLOORING. HOOK ENDS A AND B AND PROCEED AS IN THE FIRST EXAMPLE, BUT DRAWING THE CABLE DIRECTLY OUT OF THE SWITCH HOLE.

- Go fishing. Fishing is the electrician's art of sending a wire through a hole at one end of a wall or ceiling and mysteriously retrieving it out another. Fish wire is steel tape 3/16" wide and 1/16" thick. It is stiff enough to maintain direction when being forced through an invisible passage, yet flexible enough to bend around corners. As with the sport, the essential skill in fishing is patience, and there's no need to pay an electrician's rates for that.
- Resort to surface wiring only where exposed circuits will not detract from the architecture, nor give the room a jury-rigged appearance. In a kitchen, for example, multiple outlet strips can prove a great convenience along countertops. They are so in keeping with the appliances they serve, that their obtrusive appearance can be acceptable. In most other rooms, however, surface wiring along wall or baseboard looks amateurish.
- Locate switchplates, sockets, and other surface hardware so that it is entirely in the wall or baseboard, but not half-and-half. Never place a switch or socket in the door trim.

Light Fixtures

An electric light fixture is essentially a decorative shell for wires, socket and bulb. **Wherever possible, it is desirable to retain and utilize the light fixture original to the house.** If the illumination level is insufficient, try to supplement the original light with extra fixtures elsewhere in the room rather than substituting a new fixture for the old one in the same place.

Electricity came to Oakland on January 2, 1885, and in 1892 the Oakland Gas, Light and Heat Company built the first A.C. generator at 5th and Grove. Houses built prior to that time, the early Victorians, used gas and kerosene as a fuel for light. The fixtures were massive in form, made of cast iron and white metal with ceramic ornaments and etched shades. Later Victorian and some Colonial Revival houses built or "modernized" subsequent to electrical service had fixtures with separate electric lights and gas jets, just in case. These fixtures were made of brass or bronze, and because the

metal was shaped rather than cast, the form of the fixtures was more graceful. The shade was typically opalescent or vaseline glass. After the turn-of-the-century, electrical lighting became increasingly common, and by 1915 there were 45,279 consumers of electricity in Oakland. Initially, the electric fixtures looked a lot like the gas fixtures that preceded them. Often they were made of square brass stock, and the oxidized copper finish was introduced. For shades, artglass, such as the Tiffany dome, became popular, although the utilitarian, bare bulb fixture persisted into the 1920's.

If there are original fixtures or remnants thereof, they can be made serviceable. Often this is just a matter of installing new standard electrical parts, an inexpensive operation. If you don't know enough about electricity to do this yourself, an electric repair shop can do it for you and it usually costs less than \$10.

If you choose to replace old fixtures in kind, seek an original or a legitimate reproduction at salvage yards and historic speciality stores. To satisfy the *Oakland Electrical Code*, replacement light fixtures must be UL labeled. Typically this disqualifies used fixtures. When selecting reproductions, make sure they are authentic and not just suggestive of "olden days." Pick a simple reproduction instead of the most elaborate one you can find. Make sure the materials are honest. If the copy is nothing more than a chintzy imitation, the house is better off with a straightforward modern fixture. Authentic reproductions of Victorian and Colonial Revival light fixtures are available at Sunrise Salvage, San Francisco Victoriana, and Nowell's in Sausalito.

Modern electric light fixtures are usually necessary to replace and to supplement originals. Furniture stores often sell lamps along with other home furnishings, and lighting stores are so well stocked that they are overwhelming. To keep a clear head, use these guidelines:

- **Determine the function of the light.** Is it for general illumination? Is it light to work by? Is it concealed or indirect light? Is it a spotlight? Is it for security?
- **Determine the quality of light desired.** If only the quality of sunlight could be captured indoors!

LIGHT FIXTURE: DO'S AND DON'T'S

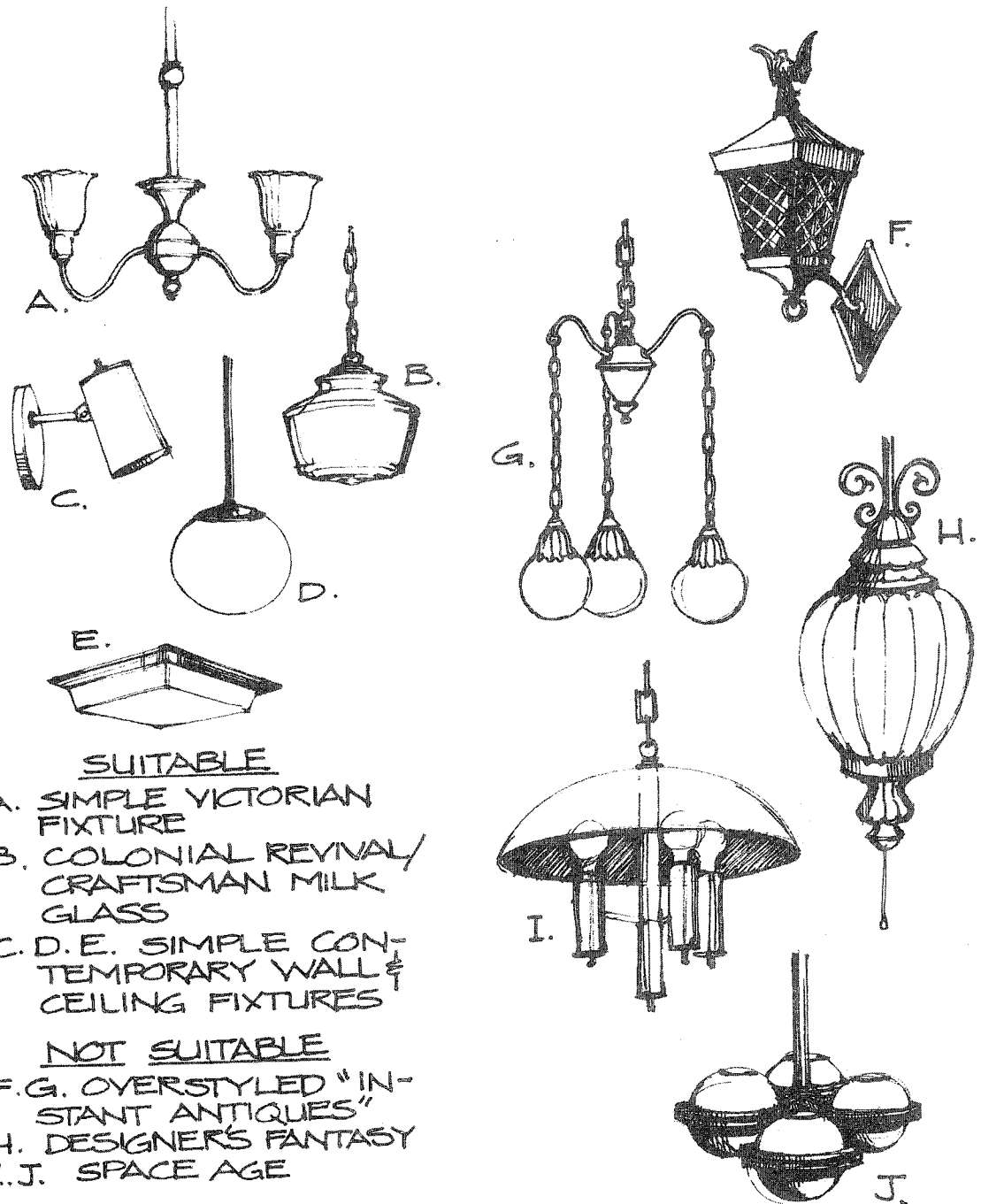

SUITABLE

- A. SIMPLE VICTORIAN FIXTURE
- B. COLONIAL REVIVAL/CRAFTSMAN MILK GLASS
- C. D. E. SIMPLE CONTEMPORARY WALL & CEILING FIXTURES

NOT SUITABLE

- F. G. OVERSTYLED "INSTANT ANTIQUES"
- H. DESIGNER'S FANTASY
- I. J. SPACE AGE

It is the easiest light to read by and the most flattering to people's appearance. The choices are limited however, to fluorescent and incandescent lights. Basically, white light is a mixture of all colored lights together. In fluorescent light, the wave lengths at the blue end of the spectrum predominate; in incandescent light the wave lengths at the red and yellow end of the spectrum prevail. Incandescent light is warmer than fluorescent. It also seems more natural because while sunlight has a red-yellow glow in early morning and late afternoon, it never seems blue. Incandescent light throws a shadow because the light is directed, again like the sun. Fluorescent does not because the light is more evenly diffused, like on a foggy day. **Indoors, use incandescent light as a general rule.** Reserve fluorescent light for work areas, like a shop, and for indirect lighting, like behind a valance. Although normally used in the kitchen, fluorescent light makes food look unappetizing, so think twice before making this common decision. Wherever fluorescent is a must, buy the "warm white" type to minimize its inherent disadvantages.

- **Select as simple a fixture as possible.** Select geometric forms without ornamentation. Select plain surfaces without gaudy glamor. Select honest materials, not vinyl look-alikes.
- **Select a fixture in scale with the room and the wall.** If there is a high ceiling, use a pipe or pole fixture to bring the chandelier down to a practical level. If the room is small use a wall fixture that minimizes intrusion into the useable space. Do not use a gigantic or ostentatious lamp in a small room, or that is all you will see.
- **Install the fixture high enough** to cast light down on the people and objects in the room. Immobile wall fixtures should be above eye level, but below the cornice molding.
- **Do not feel obligated by convention to install a central ceiling light.** Although it provides the convenience of illuminating a dark room by a switch at the door, it is otherwise relatively useless in providing good light for specific activities.

A combination of wall lights and floor or table lamps is much more effective in illuminating given areas for work or leisure, and far more flexible in accommodating the different uses a room may be put to. If there is a ceiling socket in place and it's time for a new fixture there, consider track lighting. It provides several direct and adjustable light sources, and it is visually compatible with all the architectural styles discussed in RE-HAB RIGHT that have a plain ceiling (without a rosette). Also consider the use of dimmers, as the optional light levels let you create different atmospheres for different occasions.

Plumbing

The plumbing system is made up of two separate lines. The fresh water supply line brings water into the house under 50 to 80 pounds per square inch of pressure from the main in the street. The supply line is divided at the hot water heater, where part of the incoming flow is heated. From there, pipes with hot and cold fresh water run parallel to one another and serve plumbing fixtures throughout the house. The second line is the drain-waste-vent line (DWV). It carries used water out to the sewer by gravity, and noxious fumes up into the air at roof level.

In most Oakland houses built before World War II, the water supply line is constructed of galvanized steel and the DWV line of cast iron. Galvanized pipes may become fragile with age due to corrosion and frozen fittings, but **if the plumbing system is in good or repairable condition, there is no need to update it to copper or plastic.** Additions to the existing system can be made with copper or plastic, as long as a proper transition fitting is used.

The service from the water main to pre-war houses is typically a 1/2" pipe. In 1949, 3/4" pipe became the standard. When the service pipe becomes encrusted, the inside diameter may be considerably smaller than its name implies. It is only necessary to consider upgrading plumbing service from 1/2" to 3/4" pipe if you experience a disturbing reduction in the quantity of water available when two fixtures are used at once, or if you are building an additional bathroom.

The connection between the DWV line and the sewer on the street is broken in practically one out of four old houses in Oakland, according to a City inspector. Look for rodent burrows, broken curbs, and a bright green tree in a brown lawn as evidence. If you suspect a broken sewer connection, call the Sewer Maintenance Department, 273-3846.

Most of the plumbing system is hidden and has a limited bearing on the architectural character of the house. However, like electricity, installation and repair of pipes in an older house is a matter of carpentry as well as plumbing know-how. A drill with a hole saw bit, for example, is as handy as a pipe wrench.

When adding new pipes, or when improving the old, do as little damage as possible to the original materials and spaces of the house:

- Installation of a second story toilet or bathtub requires a "P" shaped trap below the floor. Conceal this pipe between the joists; never lower the first story ceiling to hide it.
- Use existing holes in wall or floor for pipe connections, even if the new holes will be out of sight behind cabinets.
- Use hidden passages, crawl space, abandoned vents, and the like, to hide new runs of pipe and minimize destruction of valuable wainscot or plaster walls.
- On the exterior, locate pipes and vents as inconspicuously as possible, preferably on the back or sides of the house. Paint the pipe the same color as the wall behind it.

The most obvious parts of the plumbing system are the fixtures in the kitchen and bathroom. These two rooms, in that order, are the most commonly remodelled and redecorated rooms in the American house. As a result, valuable porcelain and vitreous china sinks, tubs and toilets, many with luxurious brass hardware, were removed in favor of something more modern, though undoubtedly less sturdy. **If the original plumbing fixtures are still in place, retain them.** There is nothing intrinsically wrong with a pull-chain toilet, for example, if it

A CLAWFOOT TUB WITH ADDED SHOWER

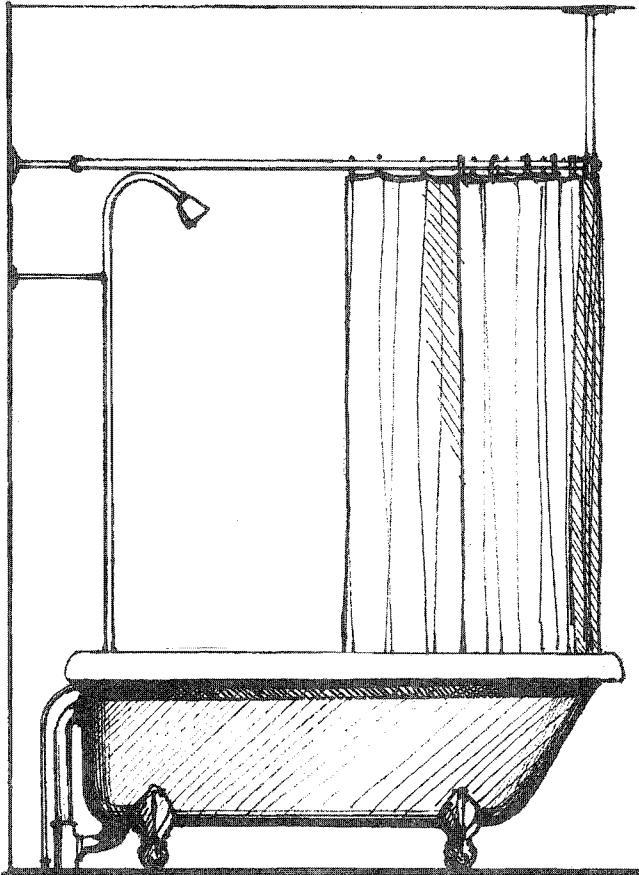

works properly. A testimonial to its value is the price tag on a new one at Markus Hardward: \$375.

Porcelain often shows signs of age. Stains can be reduced with a Clorox solution. Use about ¼ cup to a gallon of water, and let it soak the stains for 24 hours. Cracks and chips can be permanently corrected by the Porcelain Patch and Glaze Company in Oakland. They have developed a special process by which the tub is re-surfaced with a high-gloss plastic that is "good as new" according to a company representative. You can see for yourself at their showroom at 966 86th Avenue. Clawfoot tubs can be re-surfaced right in the home, and the cost

is about \$195. The price for resurfacing porcelain sinks begins at \$85. Call them for precise information on a specific fixture, 635-2188.

A temporary improvement to dings in porcelain is a special epoxy glue, but those who have tried it report mixed results. Success depends a great deal on the efficacy of cleaning the surface first. The easiest option is to learn to love the cracks as badges of antiquity. Care for porcelain with a non-abrasive cleanser, like Bon Ami, Kohler, or Mulekick.

An older sink, toilet or tub may have a cross-connection, and this demands correction. A cross-connection occurs when the supply line is placed in so low a position on the fixture that accumulated "used" water could enter the fresh water line and contaminate it. For a toilet with a cross-connection, install a new Fluidmaster type ballcock. It costs \$6.39, certainly less than a brand new toilet. If the faucet of a clawfoot tub is below the rolled tub rim, the spigot can be replaced with a spout that arches above the waterline, although swan neck spigots are fragile. To meet the Oakland codes, the spout must be at least one inch above the overflow.

Clawfoot tubs can be converted into a combination shower and bath without modifying the pipes. A single piece of hardware, with faucets, extension pipe, and showerhead, is available at several plumbing supply stores, like Meyer's, Suenemann, and J & J. The cost ranges from \$34.50 to \$63.40, depending on the brand. These stores also carry the requisite circumferential shower curtain rods. Again the price depends on the exact brand and design, varying from \$14 for the d-shaped, wall flange and ceiling support type, to \$59 for the circular frame with floor pole model.

If the clawfeet are covered by so many layers of paint that they look as if they are wearing socks, use a chemical stripper to disclose the detail. Mask the area around the tub carefully. Use an enamel spray paint suitable for metal to repaint the feet and the outside of the tub. If masking is not possible, use a brush-on enamel paint suitable for metal, like Rustoleum, and a good quality brush with fine bristles. A cheap brush will leave stroke marks.

While it is preferable to keep the tub unenclosed

and display it like a piece of sculpture, some people choose to box it in. If you do, be certain to leave a 12" by 12" hinged access panel to the above-floor pipes at the head of the tub, as these require occasional attention.

If the original bathroom accessories are gone, simplicity is the rule for selecting modern fixtures. Look for real materials. Marbleized plastic that is meant to look like stone is an obvious fake that drives up the price of lavatories and vanity tops.

To replace missing porcelain fixtures with the real thing, try salvage yards. A used tub, 5' long, as is and without hardware, costs \$125 at Sunrise Salvage; a reconditioned tub costs \$235. To replace missing brass or brass-plated plumbing hardware, try salvage yards again. At Sunrise Salvage rebuilt brass faucets start at \$55 for the sink, and \$65 for the tub. Legitimate reproductions of original brass hardware are available at San Francisco Victoriana. Many hardware and department stores now carry brass for the bathroom too.

In kitchen and laundry porch, a common problem is dry rot in the wood structure around sinks. If the original design did not include an effective splash area, the wall and floor can become deteriorated with continual exposure to water. Correct dry rot around sinks before replacing them, and make sure there is adequate drainage and waterproofing to prevent recurrence of the same situation.

A plumbing permit is required for all plumbing work other than minor repairs. Except for complicated mid-run re-piping, plumbing is within reach of the technically adept homeowner. Approximately one out of four plumbing permits is issued to a "do-it-yourselfer."

If the job is beyond your ability, or if you plan to sell the house within a year, hire a professional plumber. He or she should have a C-36 Plumbing License. While a general contractor is allowed by law to take out a plumbing permit and do the work if they are the prime contractor on a job involving three or more separate crafts, it is generally wise to stick with a specialist. One pro has observed that among plumbers, those that have been in the business for 10 to 15 years have the most reliable combination of experience and enthusiasm. Any con-

tractor doing plumbing work in Oakland must register with the Plumbing Inspection section.

Mechanical

The mechanical system is so named because it involves machines, unlike electricity and plumbing which are essentially delivery systems. In the home, the mechanical system manages the distribution of air: heating, ventilation and air conditioning. With a few exceptions, noted below, improvements to the mechanical system have limited bearing on the architectural character of the house, so the repair aspects are not addressed in detail here.

A variety of heating devices are represented in Oakland's older houses. The assortment includes: floor furnace, wall heater, single space or room heater, floor and wall combination heater, central steam heat with radiators, central warm air with ducts and registers, central forced air with ducts and registers, and, where modernization has occurred, electric heat. The individual units listed first, are typical to smaller houses, while the central heating systems are more common to larger houses.

The floor furnace is associated with the Craftsman and California Bungalows, but in fact, it was installed in new houses well into the 1950's. **There is nothing intrinsically wrong with a floor furnace**, despite the fact that FHA frowns on them. Check underneath the house to make sure that the pipe which vents the floor furnace is still connected and in good repair. They are prone to rusting, and unless their condition is intentionally examined, a malfunction can go unnoticed. At the insistence of FHA, floor furnaces are often replaced with vertical

wall heaters. This is a very poor trade-off. The floor furnace is safer, more efficient, and much better suited to the architectural style of the house than a wall heater. The drawback of the floor furnace is the hot grill cover.

Steam radiators in older houses can be a symphony of noises. Replacement of the central furnace will do nothing to stifle the hisses, gurgles, and thuds because they are generated by the steam distribution mechanisms—the pipes, radiators, and air valves. *The Old-House Journal* offers technical guidance for tracking down the cause of the noise and silencing it.

The 1977 *Oakland Housing Code* requires that in all new residential construction the heating facilities be adequate to maintain a temperature of 65 degrees three feet off the floor in all habitable rooms. A habitable room is defined as any space used for living, sleeping, eating or cooking. Bathrooms, closets, halls, storage and utility areas are not regarded as habitable areas. While this can be used as a guideline for older houses, the legal requirement for houses built prior to 1958 is entirely different. In those dwellings, there is no requirement for heating, other than retaining the level that the original heating facility provides. If, for example, a floor furnace is the only heater in the house, there is no City requirement that additional heaters be provided in unserved rooms. Or if, in a single-family dwelling, there is no heater at all and there never was, the *Oakland Housing Code* does not require that a heater be installed. However, FHA and other lending institutions have more stringent standards, and they may demand installation of additional heaters in a house as part of the financial agreement.

Additions to an inadequate heating system invariably

ably have a visual impact, so try to minimize the intrusion. Consider upgrading the system you already have—with the installation of supplementary registers, for example—rather than switching to a brand new set-up that engenders exposed duct work or bulky room units. If you must introduce a new permanent heating device to an unserved room, baseboard heaters are usually the least obtrusive. The Intertherm type are considered especially good by some, due to their safety, control, and humidity features. Remember, a mechanical permit is required by the City for all mechanical work done except minor repairs.

Before expanding the heating system in the house, make sure that the building is properly insulated to prevent heat loss. You may find that new insulation is a better solution than a new heater. A free booklet entitled "Facts on Home Insulation" is available from the Better Business Bureau, 360 22nd Street, Oakland, if you send them a self-addressed, stamped, legal size envelope. Also, examine your heat consumption habits to determine if heat and energy are being unnecessarily wasted.

For safety purposes, make sure that all gas appliances are vented to approved flues which terminate above the roof with a cap. As evidence of an appliance malfunction, look for sooting atop the vent. The City will make a survey of the mechanical system of the house for \$23, minimum, and pinpoint its hazards and shortcomings. Contact the Inspection Services Department.

If you install a window type air-conditioner, it is advisable for esthetic reasons to place it in a side window rather than a front window. This keeps the facade of the house uninterrupted, and the street scene more orderly. 

Chapter 6.

SOURCES AND RESOURCES

CITY OFFICES

Civil servants are available to help you, but sometimes it's hard to track down the right person on the telephone. Use this list as a shortcut to the offices which handle matters related to rehab. Telephone numbers, addresses, and programs are current as of April, 1980.

For general information about Oakland call *Cityline*, a joint project of the Oakland Public Library and Volunteers for Oakland, at 444-CITY (444-2489).

CITY PLANNING DEPARTMENT

Plans and Programs Division

City Hall, 6th Floor
273-3941
8:30 - 5:00

Ask for: Public Information Officer
Service: Information, publications, and referrals regarding the City's land use plans for all districts in Oakland
Census data
When to call: If you are interested in the future of a specific area or the City as a whole
Fee: No charge for information or publications

Development Controls Division

City Hall, 11th Floor
273-3911
8:00 - 5:00

Ask for: Zoning Technician
Service: Explanation of the *Zoning Regulations*, the legal document

which governs the use and amount of building allowed on a parcel
Processing requests for variances and use permits that may be required to make improvements or meet applicable code

When to call: Before buying a house
Before creating more dwelling units, whether by building an addition or dividing up the interior
Before planning new construction

Fee: No charge for zoning information
Minor Variance and Minor Conditional Use Permit: \$35
Major Variance and Major Conditional Use Permit: \$125

Upon request, a member of the Development Controls Division will explain the *Zoning Regulations* to assembled groups, such as neighborhood associations.

OFFICE OF COMMUNITY DEVELOPMENT

Housing Department

1417 Clay Street
273-3531
8:30 - 5:00

Ask for: Mortgage Advisor
Service: Administration of rehabilitation assistance programs (Refer to list of programs in this chapter.)
When to call: If you are investigating the best way to finance a rehab project
Fee: No charge for information

Housing Conservation

City Hall, Room 110
273-3381
8:00 - 4:30

Ask for: Housing Representative
Service: Building inspection for violation of applicable codes
When to call: If you are planning to rehabilitate a house for resale through an FHA, GI, or other loan program
If you need a Certificate of Occupancy
If you want to register a complaint against a probable housing code violation
If a hazard clearance is required
Fee: \$85 per building for a full inspection to determine com-

pliance with applicable housing, building, electrical, plumbing and mechanical codes
\$10 for each additional unit.
The fee includes the certificate of occupancy if corrections are completed, or substantial progress made, within six months.

The Housing Representative is obliged to report any observed violations of applicable code, and to follow up on the report. The correction of safety hazards is required.

Housing Counseling Agency

1417 Clay Street
273-3056
8:30 - 5:00

Ask for: Housing Counselor
Service: Counseling services on home purchase and maintenance, budget management, default and delinquency, discrimination
When to call: For general information or specific counseling on the purchase or rehabilitation of a house in one of the Community Development Districts
Fee: No charge

Program Planning and Coordination

1417 Clay Street
273-3716
8:30 - 5:00

Ask for: District Coordinator for your Community Development District
Service: Information on community development plans for neighborhoods in Community Development Districts
Schedules of public meetings and hearings related to such neighborhood improvements
When to call: If you are interested in a specific neighborhood in a Community Development District
Fee: No charge

OFFICE OF PARKS AND RECREATION

Parks Services

7101 Edgewater Drive
273-3151
7:00 - 3:30

Ask for: Park Services Manager
Service: Development and maintenance of City parks and street trees
When to call: To find out if any new parks are planned for your neighborhood or if improvements are slated for existing parks
To participate in planning for new parks
To find out if street tree planning is scheduled for your block
To find out how to get street trees planted
Fee: No charge for information

OFFICE OF PUBLIC WORKS

Engineering Services

City Hall, 8th Floor
273-3871
8:00 - 4:30

Ask for: Engineering Information Counter
Service: Provision of engineering records
Issuance of grading and encroachment permits
Information on flood hazards and seismic study zones
Review of building plans, parcel maps, and subdivision maps
When to call: Before buying a house or property
When contemplating improvements that may affect public property
Fee: No charge for information

Inspectional Services

City Hall, 11th Floor
Building Section: 273-3441
Electrical Section: 273-3341
Plumbing Section: 273-3291
8:00 - 4:30

Ask for: Building Inspector, Electrical Inspector, Plumbing or Mechanical Inspector

- Service:** Issuance of Permits
 Review of permit applications and plans
 Inspection of buildings and construction for compliance with the *Oakland Building Code, Oakland Electrical Code, Oakland Plumbing, Oakland Mechanical Code*, and other related laws
 Administration of regulations pertinent to residential rehabilitation
- When to call:** When the extent of proposed work is determined, but the work has not yet begun
- Fee:** The fee for permits is derived from the cost of construction and the number of hours required for inspection.

Inspectional Services
Sidewalks and Weed Abatement

City Hall, 6th Floor
 273-3651
 8:00 - 4:30

- Ask for:** Sidewalk Inspector or Weed Abatement Inspector
- Service:** Inspection of sidewalks, curbs, gutters, driveways, and vacant property for hazardous obstructions and weed problems
- When to call:** To report hazardous weed or sidewalk situations
 To seek advice related to curb or sidewalk repairs
 To request an inspection
- Fee:** There is no charge for the inspection. However, if the hazard is on your property, you will be charged for its correction.
 The cost of construction or weed removal is based on the price the low-bidding contractor charges the City.
 If a street tree has caused the sidewalk damage, you may lose the street tree.

REHABILITATION ASSISTANCE PROGRAMS

The City administers programs that help finance residential rehabilitation in Oakland. The programs are subject to change, and should be confirmed with the City representative indicated. This list is current as of April, 1979.

312 Loan Program

Summary: The 312 program offers rehabilitation loans at 3% interest rate, payable over 20 years, and secured by a Deed of Trust.

The maximum loan amount is \$27,000 per dwelling unit.

Eligibility: The house must be located in a Community Development District. Although the house need not be owner occupied, preference is given to low and moderate income owners.

For more information: Office of Community Development
 Mortgage Servicing
 273-3531

Home Maintenance Improvement Program (HMIP)

Summary: HMIP offers below market interest rate loans to owner occupants for rehabilitation. Loan amounts are up to \$30,000 for a single family house and \$5,000 for each additional dwelling unit up to four units. The interest rate is 3%. The maximum term is 20 years. The loans are made from a revolving fund appropriated from the Community Development Block Grant.

Eligibility: Owner occupied one to four unit house in a Community Development District.
 Adjusted gross annual income: less than 80% of Bay Area median by family size (\$16,550 maximum for family of four).

For more information: Office of Community Development
 Mortgage Servicing
 273-3532

Marks-Foran Rehabilitation Loan Program

Summary: Fourteen separate local lenders offer purchase loans and rehabilitation loans at 10½% interest. The City of Oakland has made funds available to the lenders for this program. Loans may be used for: single family houses, townhouses, condominiums, and multi-family dwellings of 2-4 units. The property must be owner-occupied. It may be located anywhere in the City of Oakland.

Eligibility: Applicant's Annual Gross Income must be less than: \$31,000 if the property is located in a Community Development District; \$24,800 if the property is not located in a Community Development District.

For a purchase loan, the purchase price of the property cannot be more than \$79,000. A minimum down payment of 5% is required, unless applicant qualifies for FHA or VA financing. For a rehabilitation loan, the loan amount cannot be more than \$79,000. Rehabilitation must first be financed with a conven-

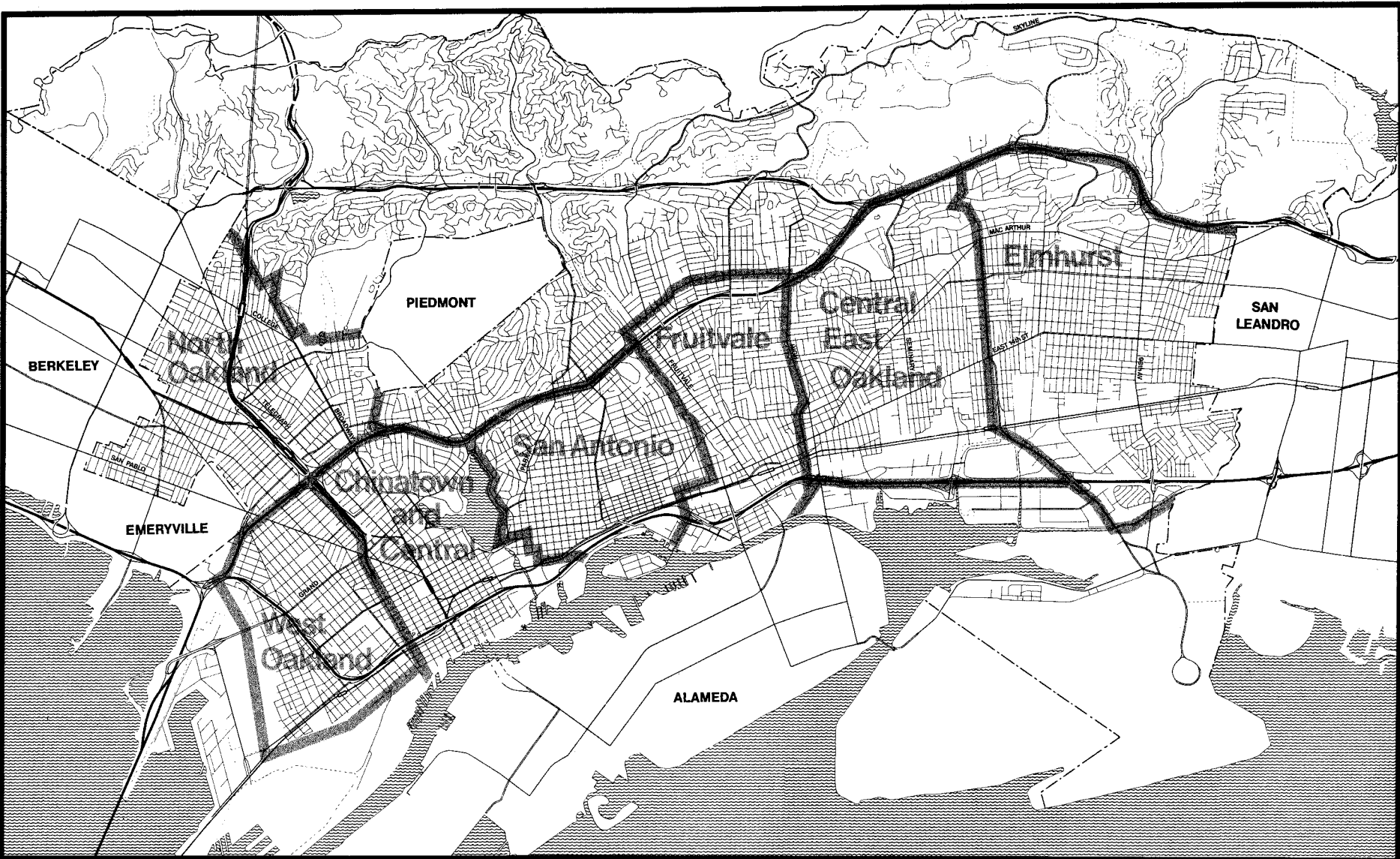

Community Development District Boundaries



Base Map © 1981/1982 by North American Map, San Francisco, Ca. For use by City of Oakland only. Reproduction of map or portions thereof without the written permission of North American Map is prohibited.

tional, short-term loan. All rehabilitation work must be completed before a long term loan can be made. Work must have started since October 1, 1979.

For more information: To obtain a flyer which names the lenders participating in this program:
Office of Community Development
Public Information
273-3470

Paint and Weatherization Program

Summary: Free material and labor for exterior painting and installation of weatherization are available under this program. It is funded by grants from the Community Services Administration and the State of California.

Eligibility: Owner occupied house in a Community Development District
Property certified in sound condition
Low income status, by formula (Family of four: \$8,900 adjusted gross income)

For more information: Office of Community Development
Housing Counselor
273-3056

Self-Help Paint Program

Summary: The City provides free paint and equipment (brushes, pans, rollers) for people who are painting their own house. Attendance at a one session training course is required.

Eligibility: Owner occupied house in a Community Development District
Low income status, according to formula (Family of four: \$16,560 adjusted gross income) or HMIP loan recipient.

For more information: Office of Community Development
Housing Counselor
273-3056

Urban Homesteading Program

Summary: For a \$1 fee, \$300 to \$600 in closing costs, the promise to rehabilitate the structure in 18 months, and a commitment to occupy it for five years, the City sells repossessed HUD houses in Community Development Districts. Often, 312 Loans are made available to homesteaders to help with the rehab. Note: No additional applications accepted in 1980.

Eligibility: Family owns no other real property
Family has the ability to pay rehab costs
Head of household, is 18 years or older, and U.S. citizen or resident alien

Preference given to applicants who are:
Oakland residents (for one year prior to applying)
Married with children
Single with children
Over 62 years of age
Supporter of elderly parents who live in household
At adjusted family income level between \$6,000 to \$16,500 (based on family size)

For more information: Office of Community Development
Housing Counselor
273-3056

Vacant Housing Program

Summary: The Housing and Rehabilitation division maintains a list of houses rehabilitated by Oakland Better Housing, Inc. that are for sale. The prospective buyer may be assisted in financing the purchase.

For more information: Office of Community Development
Housing Counselor
273-3502

Lead Poisoning Prevention Project

Summary: The Environmental Health Division of the Alameda County Health Care Agency will arrange for free repainting of the interior of an Oakland house if the existing paint has a hazardous lead content and there are children under six years old in residence. The Peralta Service Corporation assists in the repainting effort.

Eligibility: Houses in which children have contracted lead poisoning are given highest priority. Other houses in which lead paint is suspected, and a young child resides, will be evaluated at the request of the property owner.

For more information: Gordon Coleman
Alameda County Health Care Agency
874-7224

Louis Briones
Peralta Service Corporation
1248 35th Avenue
Oakland, CA 94601
534-1650

CLASSES

There are many classes available in the East Bay where you can learn more about architectural history and home repair skills. Call the institution that interests you to order a catalog, find out the schedule, and evaluate the teacher's experience. Titles listed here are examples of classes offered in recent years.

City Of Oakland

Office of Community Development
Housing Counseling Services
1417 Clay Street
273-3056
8:30 - 5:00

- Shopping for a Home, Codes and Permits, Plumbing Repairs, Security, Electrical Repairs, Painting, Preventative Maintenance, Insulation and Weatherproofing, Loan Program Orientation
- Evenings, weekends, various locations
- Free

Peralta College For Non-Traditional Study

2020 Milvia Street, Suite 200
Berkeley
841-8431

or

1900 Fruitvale Avenue, Room 3E
Oakland
533-1830

- Home Maintenance and Repair
- Evenings
- Free to residents of the Peralta College District (includes Oakland)

Merritt College

12500 Campus Drive
Oakland
531-4911

- Real Estate, Home Remodeling and Renovation, Carpentry
- Daytimes, Evenings
- \$2 registration fee

Laney College

900 Fallon Street
Oakland
834-5740

- Carpentry, Oakland History, Architectural and Engineering Technology
- Daytimes
- Registration fee \$2

Oakland Public Schools Adult Education

836-2622, ext. 831

- Home Maintenance, Architectural History of the East Bay, Interior Decorating
- Evenings, various locations
- \$3 registration fee (for one or more classes)

Owner-Builder Center

1824 Fourth Street
Berkeley, CA 94710
848-5950

- Remodelling, House Building
- Evenings, weekends
- \$25-\$200, scholarships available.

Piedmont Adult School

800 Magnolia Avenue
Piedmont
653-9454

- Architectural Heritage of the East Bay, Architectural History of California, Cabinet Making, Interior Decorating
- Evenings and weekends
- \$10 Registration fee (for one or more classes)

Open Education Exchange

655-6791

- Home Remodelling, Home Plumbing, Home Electrical Systems
- Evenings, various locations
- Fees vary

University Extension

University of California
Berkeley
666-3292

- What's In a House, Victorian Construction and Reconstruction, Victorian Interiors, Bay Area Architecture, West Coast Architecture
- Evenings, weekends, various locations
- Fees vary, typically \$25 to \$100

Camron-Stanford House

1418 Lakeside Drive
Oakland
836-1976

- In depth programs on Oakland history and domestic lifestyles
- Noontimes, evenings, weekends
- Most are free

BOOKS

These publications are prominent in the extensive library of reference material used in the preparation of REHAB RIGHT. While this is a selected bibliography only, the list provides further reading on specific subjects addressed in preceding chapters. Additional books and periodicals of special interest are alluded to in the text.

An asterisk(*) indicates availability at the **Oakland Public Library**. If the book you desire is not on the shelf at the main building or the branch convenient to you, it can be reserved, or requested from another library.

Architectural History

- *Bean, Walton E. *California: An Interpretive History*. New York: McGraw-Hill Book Co., 1968.
- Dykstra, John Beatty. *A History of Physical Development of the City of Oakland: The Formative Years, 1850 - 1930*. Thesis for a Masters Degree in City Planning. University of California, Berkeley.
- *Fleming, John, Hugh Honour, Nikolaus Pevsner. *The Penguin Dictionary of Architecture*. Hammondsworth, England: Penguin Books, Ltd., 1966.
- *Freudenheim, Leslie Mandelson, and Elisabeth Sacks Sussman. *Building with Nature: Roots of the San Francisco Bay Region Tradition*. Santa Barbara: Peregrine Smith, Inc., 1974.
- *Gebhard, David, et al. *A Guide to Architecture in San Francisco and Northern California*. Santa Barbara: Peregrine Smith, Inc., 1973.
- *Kirker, Harold. *California's Architectural Frontier*. Santa Barbara: Peregrine Smith, Inc., 1974.
- *Oakland City Planning Department. *Oakland's Form and Appearance: An Evaluation Based on the 701 Urban Design Study*. Oakland, 1968.
- *Olwell, Carol and Judith Lynch Waldhorn. *A Gift to the Street*. San Francisco: Antelope Island Press, 1976.
- *Richey, Elinor. *The Ultimate Victorians of the Continental Side of the San Francisco Bay*. Berkeley: Howell-North Books, 1970.
- Whiffen, Marcus. *American Architecture Since 1780: A Guide to the Styles*. Cambridge: The M.I.T. Press, 1969.
- *Woodbridge, Sally, et al. *Bay Area Houses*. New York: Oxford University Press, 1976.
- Yoho and Merritt. *Craftsman Bungalows*. Seattle: 1910.

Rehabilitation and Repair

- **America's Handyman Book*. The Staff of the Family Handyman. New York: Charles Scribner's Sons, 1970.
- **Basic Home Repairs Illustrated*. The Editors of Sunset Books and Sunset Magazine. Menlo Park: Lane Books, 1974.
- Directory 77*. Jay Turnbull, ed. San Francisco: The Foundation of San Francisco's Architectural Heritage, 1977.
- *Grow, Lawrence. *The Old House Catalogue*, New York: Main Street. Universe Books, 1976.
- **New Life for Old Dwellings: Appraisal and Rehabilitation*. U.S. Department of Agriculture, Agriculture Handbook 481, Washington D.C., 1975.
- **Reader's Digest Complete Do-it-yourself Manual*, Pleasantville, New York: The Reader's Digest Association, 1973.
- *Stephen, George. *Remodeling Old Houses Without Destroying Their Character*. New York: Alfred A. Knopf, 1976.
- **The Old-House Journal*. Volumes I - VI. Brooklyn: The Old-House Journal Corporation, 1973-1978.
- The Old-House Journal Buyers' Guide*, 1977. Editors of *The Old-House Journal*. Brooklyn: The Old-House Journal Corporation, 1976.

The Old-House Journal and the *Reader's Digest Complete Do-it-yourself Manual* are frequently referred to in the text and serve as companion publications to REHAB RIGHT. The Oakland Public Library has agreed to order back issues of *The Old-House Journal* and additional copies of the *Reader's Digest Complete Do-it-yourself Manual* for the convenience of REHAB RIGHT readers. To acquire personal copies, you can purchase the *Reader's Digest* book at C. Markus Hardware, in Oakland, and subscribe to the periodical by writing to *The Old-House Journal* Corporation, 199 Berkeley Place, Brooklyn, New York 11217.

The U.S. **Government Printing Office Bookstore**, 450 Golden Gate Avenue, San Francisco (8:00 to 4:00, Monday through Friday) carries informative yet inexpensive pamphlets on home maintenance and repair. For specific titles, call 556-6657.

For more academic research, visit the **California Room** of the Oakland Public Library, and the **Environmental Design Library**, Wurster Hall, University of California, Berkeley.

PRESERVATION ORGANIZATIONS

Preservation and historic organizations provide an opportunity to meet people who share an interest in old houses. The groups schedule lectures, slide shows, and house tours for their membership. Often, the general public is invited too. To varying degrees, preservation organizations are also involved in the political process, lobbying for landmarks legislation and governmental action to save valuable buildings from demolition and insensitive remodeling.

Alameda County Historical Society

c/o Mrs. Robert H. Swadley, President
5461 Fernhoff Road
Oakland, CA 94619
531-0222

Alameda Victorian Preservation Society

P.O. Box 1677
Alameda, CA 94501

Berkeley Architectural Heritage

P.O. Box 7066 Landscape Station
Berkeley, CA 94707

Brooklyn Neighborhood Preservation Association

c/o Peter Carlson
1937 8th Avenue
Oakland, CA 94606

Californians for Preservation Action

P.O. Box 2169
Sacramento, CA 95810

Camron-Stanford House Preservation Association

1418 Lakeside Drive
Oakland, CA 94612
836-1976

East Bay Negro Historical Society

4519 Grove Street
Oakland, CA 94609
658-3158

The Foundation for San Francisco's Architectural Heritage

2007 Franklin Street
San Francisco, CA 94109
441-3000

Landmarks Preservation Advisory Board

c/o Oakland City Planning Department
1421 Washington Street
Oakland, CA 94612
273-3911

National Trust for Historic Preservation

Western Regional Office
681 Market Street
San Francisco, CA 94105
543-0325

Oakland Museum Association

1000 Oak Street
Oakland, CA 94607

Council on Architecture

273-3055

History Guild

273-3842

PANIL Notes

Piedmont Avenue Neighborhood Improvement League

4318 Montgomery Street
Oakland, CA 94611

State of California

Office of Historic Preservation

P.O. Box 2390
Sacramento, CA 95811
(916) 322-8595

Victorian Alliance

4143 23rd Street
San Francisco, CA 94114
824-2666

Victorian Preservation Society

c/o A Central Place
Clorox Building
1221 Broadway, Suite 390
Oakland, CA 94612
834-7897

HOUSING ORGANIZATIONS

The citizen groups and non-profit organizations listed below concern themselves primarily with housing rehabilitation in Oakland. In addition, there are nearly a hundred homeowners associations and neighborhood coalitions in the City that are area specific. If the needs of the immediate community warrant, these groups too may address housing rehabilitation. For the name of your neighborhood organization, call the Oakland City Planning Department, Development Controls Division, 273-3911.

East Oakland Housing Task Force

Fran Matarrese, Chairwoman
3914 E. 14th Street
Oakland, CA 94601
261-8440

This City-appointed, 14 member commission includes representatives from the many fields involved in rehab, such as realtors, lenders, contractors, community organizations, and City staff. The East Oakland Housing Task Force convenes the second Tuesday of every month at the Office of Community Development, and their meetings are open to the public.

Oakland Better Housing, Inc. (OBHI)

Richard F. Illgen, Executive Director
1027 Adeline Street
Oakland, CA 94607
465-9911

OBHI is a non-profit corporation which acquires vacant houses in Oakland and rehabilitates them for resale to low and moderate income families. OBHI conducts the entire operation: they negotiate for property, hire construction workers, purchase materials, locate buyers, and arrange financing.

Oakland Community Organizations Housing Committee

Fran Matarrese, Chairwoman
Scott Reed, Staff Person
3914 E. 14th Street
Oakland, CA 94601
261-8440

The Oakland Community Organizations Housing Committee helps to develop and monitor rehabilitation assistance programs administered by the Office of Community Development, and other public agencies. They meet with legislators regarding allocation of State and Federal funds to support such measures. The Oakland Community Organizations Housing Committee has absorbed the East Oakland Housing Committee.

Oakland Neighborhood Housing Services (ONHS)

Kenneth Nunn, Executive Director
1641 98th Avenue
Oakland, CA 94603
632-8892

ONHS provides rehab counseling and financial assistance for home improvement projects which contribute to neighborhood revitalization in the Elmhurst District. ONHS is a partnership between residents, City government, and lending institutions.

OCCUR Housing Committee

Joseph Palacios, Staff Person
1419 Broadway
Oakland, CA 94612
839-2440

The OCCUR Housing Committee is concerned with rehabilitation, housing insurance, architectural and contractual services, fair-bidding procedures, and housing availability.

MATERIALS

REHAB RIGHT is an endorsement of design concepts, not stores. This section, therefore, offers some guidance on where to shop, rather than presenting a directory of commercial enterprises.

Stores and suppliers of special or especially handy products are mentioned in the text of this book because many of the materials needed to rehabilitate an old house without destroying its architectural character are not available at conventional hardware stores. Such **names and addresses are included solely to demonstrate that certain materials needed to REHAB RIGHT are definitely available.** No approval by the City is implied, nor does a specific reference suggest that the named supplier is the exclusive source of any item. Prices quoted are subject to change without notice. (Refer to the Disclaimer.) In a reasonable but not exhaustive search, Oakland sources were investigated first. **Buying in Oakland is encouraged.**

Conventional **hardware stores** are a good place to shop for tools and certain raw materials. They are not a good source for finished products, since the products tend to be standardized on a national scale for mass consumer appeal, and are rarely appropriate to the architectural style of Oakland's older houses. Old-fashioned hardware stores where the raw materials are in bulk or bins, rather than individually sealed plastic packages, have more charm, as well as the more unusual materials that are suited to older houses. Hardware departments in discount stores are sometimes a less expensive source of conventional items. However, the price you pay to get the discount (if indeed there is one) is the limited selection of products, and the lack of sufficient or knowledgeable sales personnel to help you out. Luckily, there are still several good hardware stores in Oakland. Look for them in neighborhood commercial districts.

Building materials suppliers, like paint stores, lumber yards, and plumbing outfitters, are the best source for raw materials because their selection is usually the largest, and includes older styles as well as modern. On the other hand, the selection generally includes countless doodads and wonder tools which make extravagant claims of timesaving and suitability for every job.

These can quickly run up the bill of sale. Determine, as best you can, the amount of materials and type of tools you need before going to the supplier. Qualified sales personnel can then help you select among different manufacturers.

Salvage yards are a good place to shop to replace old house parts. There are several salvage yards in the East Bay, and they are well aware of the part they play in the restoration of old houses. Unfortunately, as a result, they are often the outlet, unwittingly or otherwise, for architectural features that have been illegally plundered from extant buildings, rather than rescued from demolition. The stock at salvage yards fluctuates, so several trips, some research, and a dose of imagination may be necessary to locate what you're after.

Specialty stores and **suppliers that deal in authentic reproductions of original house parts** are a valuable resource to REHAB RIGHT, and there are a few around locally. However, putting features in a house that are from an era earlier than the building itself is as bad an anachronism as installing jarringly modern features. Make sure the reproductions are suitable to the architectural style.

Often, the only option is to find a **craftsman** who will mill or build a house part to your specification. One way to locate such individuals is in the classified ads of local newspapers, like *The Montclairion* or *The Classified Flea Market*, or to contact a preservation organization. When working with a craftsman or contractor, make certain your intention to REHAB RIGHT is clear before work begins.

Salespeople are, after all, sales people. Never let a zealot talk you into something that is contrary to the design principle expressed in REHAB RIGHT, or that is more to the store's benefit than to yours, or your house's. A salesperson profits if you buy something new. **You, your house, and the City, all profit if you keep what is original to the house.** What you've already got may be old, but as REHAB RIGHT has demonstrated, it is probably more sturdy, and definitely more appropriate to the architectural style of the house, than anything new is likely to be. ■

CREDITS

Oakland City Planning Department

Norman J. Lind, *Planning Director*

Helaine S. Kaplan, *Associate Planner*
Project Manager
Author

Blair Prentice, *Graphic Designer*
Illustrator
Co-author

Frank Ehrhardt, *Senior Planner*
Review Assistance

Christopher Buckley, *Assistant Planner*
Research Assistance

Carmelita Rickman, *Secretary*

Consultants

Charles Hall Page and Associates

Bruce Judd, *Vice-President in charge*
of Architecture
364 Bush Street
San Francisco, CA 94104

Flack and Flack

James Flack, *Real Estate Appraiser*
364 Bush Street
San Francisco, CA 94104

Production

Reproduction Services:

City Blue Print Co.

333 13th Street
Oakland, CA 94612

Typesetting:

Vera Allen Composition Service

2869 Grove Way
Castro Valley, CA 94546

Printing:

Coon Lithograph Co., Inc.

669 20th Street
Oakland, CA 94612

Thanks to

Carlos Anglin
American Institute of Planners,
California Chapter, Northern
Section
Associated Real Property Brokers
Inc. of Northern California

Jim Barthman
Steve Belcher
Ruby Ann Bims
Jerry Blueford
Jim Blyler
Ettin Bobonis
H. Jerry Calvert
John Campbell
Barbara Capolungo
John Carter
Robert Chastain
Liz Cohen
Albert Collins
Marie Converse
George Converse
Gery Edwards
East Oakland Housing
Committee
The Figueroa Family
Ernie Franklin
Tom Frye
Mike Funaro
Bob Garcia
Bob Green
Carol Hale
David Hoard
Diana Hopper
Antoinette Hewlett
Richard F. Illgen
Jim Jensen
Sandra Keith
Chris and Janet King
Roy Knight
Gary Kray
Ralph Kuschler

Landmarks Preservation
Advisory Board

Richard Lloyd
Eric Lofgren
Jack Marsh
Margo Marsh
Frank Martini
Fran Matarrese
John Merritt
Andy Meyer
Peter Mollica
Kathleen Moore
Robert Moses
Bill Northwood
Oakland Arts Council
OCCUR Urban Design
Committee
Peter Ortoljo
Charlie Perry
Ken Pietrelli
Agnes Pritchard
Ken and Deb Rattenbury
Harold Reid
Cecil S. Riley
Donna Rogers
Yolanda Robles
Gina Ryan
Henrietta Scott
Roy Schweyer
Eugene Troupe
John and Julie Signor
Dave Smith
Eileen Smith
Mike Stringer
Brian Suen
Merrill Ware
C. Kennedy Warthin
Lee White
Mary Widener
Anne Winchester
Sally Woodbridge
Janie Young

inches 1 2 3 4 5 6 7 8 9 10

2
15
10
5
cm.